



## UZ1085

## LINEAR INTEGRATED CIRCUIT

### 3A ADJUSTABLE/FIXED LOW DROPOUT LINEAR REGULATOR

#### DESCRIPTION

The UTC **UZ1085-xx** series are low dropout three-terminal regulators with 3A output current capability. These devices have been optimized for low voltage applications including VTT bus termination, where transient response and minimum input voltage are critical.

Current limit is trimmed to ensure specified output current and controlled short-circuit current. On-chip thermal limiting provides protection against any combination of overload and ambient temperature that would create excessive junction temperatures.

#### FEATURES

- \*Fast transient response
- \*Low dropout voltage at up to 3A
- \*Load regulation:0.05% typical
- \*Trimmed current limit
- \*On-chip thermal limiting

#### ORDERING INFORMATION

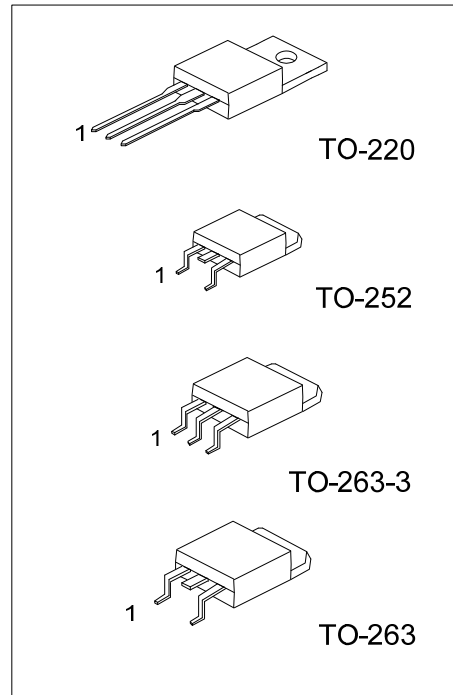

Lead-free: UZ1085L-xx  
 Halogen-free: UZ1085G-xx

Ordering Number			Package	Pin Assignment			Packing
Normal	Lead Free	Halogen Free		1	2	3	
UZ1085-xx-TA3-T	UZ1085L-xx-TA3-T	UZ1085G-xx-TA3-T	TO-220	A/G	O	I	Tube
UZ1085-xx-TN3-R	UZ1085L-xx-TN3-R	UZ1085G-xx-TN3-R	TO-252	A/G	O	I	Tape Reel
UZ1085-xx-TQ2-R	UZ1085L-xx-TQ2-R	UZ1085G-xx-TQ2-R	TO-263	A/G	O	I	Tape Reel
UZ1085-xx-TQ2-T	UZ1085L-xx-TQ2-T	UZ1085G-xx-TQ2-T	TO-263	A/G	O	I	Tube
UZ1085-xx-TQ3-R	UZ1085L-xx-TQ3-R	UZ1085G-xx-TQ3-R	TO-263-3	A/G	O	I	Tape Reel
UZ1085-xx-TQ3-T	UZ1085L-xx-TQ3-T	UZ1085G-xx-TQ3-T	TO-263-3	A/G	O	I	Tube

Note: 1. xx: Output Voltage, refer to Marking Information.

2. A: ADJ (for adjustable regulator), G: GND (for fixed regulator), O:  $V_{OUT}$ , I:  $V_{IN}$

<p>UZ1085L-xx-TA3-T</p>	<p>(1) R: Tape Reel, T: Tube</p> <p>(2) TA3: TO-220, TN3: TO-252, TQ2: TO-263, TQ3: TO-263-3</p> <p>(3) xx: refer to Marking Information</p> <p>(4) G: Halogen Free, L: Lead Free, Blank: Pb/Sn</p>
-------------------------	---

■ MARKING INFORMATION

PACKAGE	VOLTAGE CODE	MARKING
TO-220 TO-252 TO-263 TO-263-3	15 :1.5V 18 :1.8V 25 :2.5V 33 :3.3V 50 :5.0V AD:ADJ	<p>             LOT Code ←              Voltage Code ←           </p> <p>             UTC              UZ1085              XX           </p> <p>             L: Lead Free              G: Halogen Free              Date Code           </p> <p>1 2 3</p>

## ■ ABSOLUTE MAXIMUM RATINGS

PARAMETER	SYMBOL	RATINGS	UNIT
Input Voltage	$V_{IN}$	18	V
$(V_{IN} - V_{OUT}) \times I_{OUT}$		See Figure 1	
Junction Temperature	$T_J$	+125	°C
Operating Temperature	$T_{OPR}$	-40 ~ +85	°C
Storage Temperature	$T_{STG}$	-40 ~ +150	°C

Note: Absolute maximum ratings are those values beyond which the device could be permanently damaged.  
 Absolute maximum ratings are stress ratings only and functional device operation is not implied.

## ■ THERMAL DATA

PARAMETER	SYMBOL	RATINGS	UNIT
Junction to Ambient	TO-252	118	°C/W
	TO-220	62	°C/W
	TO-263	62	°C/W
Junction to Case	TO-252	12	°C/W
	TO-220	4	°C/W
	TO-263	4	°C/W

## ■ ELECTRICAL CHARACTERISTICS (Ta=25°C, C<sub>OUT</sub>=22μF, unless otherwise specified.)

### For UZ1085-ADJ (Adjustable)

PARAMETER	SYMBOL	TEST CONDITIONS	MIN.	TYP.	MAX.	UNIT
Reference Voltage	$V_{REF}$	$1.5V \leq (V_{IN} - V_{OUT}) \leq 8.25V$ $10mA \leq I_{OUT} \leq 3A$	1.225	1.25	1.275	V
Line Regulation	$\Delta V_{OUT}$	$(V_{OUT} + 1.5V) \leq V_{IN} \leq 12V$ , $I_{OUT} = 10mA$		0.005	0.2	%
Load Regulation	$\Delta V_{OUT}$	$(V_{IN} - V_{OUT}) = 3V$ , $10mA \leq I_{OUT} \leq 3A$		0.05	0.5	%
Dropout Voltage	$V_D$	$\Delta V_{REF} \% = 1\%$ , $I_{OUT} = 3A$		1.30	1.40	V
Current Limit	$I_{LIMIT}$	$(V_{IN} - V_{OUT}) = 2V$	3.1	4		A
Adjust Pin Current	$I_{adj}$			35	120	μA
Adjust Pin Current Change	$\Delta I_{adj}$	$1.5V \leq (V_{IN} - V_{OUT}) \leq 12V$ $10mA \leq I_{OUT} \leq 3A$		0.2	5	μA
Minimum Load Current	$I_{O(MIN)}$	$1.5V \leq (V_{IN} - V_{OUT}) \leq 12V$			10	mA
Quiescent Current	$I_Q$	$V_{IN} = 12V$		4	13	mA
Ripple Rejection	RR	$f = 120Hz$ , Tantalum, $(V_{IN} - V_{OUT}) = 3V$ $I_{OUT} = 3A$	60	72		dB
Thermal Regulation		Ta=25°C, 30ms pulse		0.004	0.02	%/W
Temperature Stability	$\Delta V_{OUT}$			0.5		%
Long-Term Stability	$\Delta V_{OUT}$	Ta=125°C, 1000hr		0.03	1.0	%
Output Noise(% of V <sub>OUT</sub> )	eN	Ta=25°C, 10Hz ≤ f ≤ 10kHz		0.003		%
Thermal Shutdown				150		°C

■ ELECTRICAL CHARACTERISTICS

For UZ1085-xx (Fixed Voltage)

PARAMETER	SYMBOL	TEST CONDITIONS	MIN.	TYP.	MAX.	UNIT
Output Voltage	UZ1085-15	$3.0V \leq V_{IN} \leq 8.5V, 10mA \leq I_{OUT} \leq 3A$	1.470	1.5	1.530	V
	UZ1085-18	$3.3V \leq V_{IN} \leq 8.8V, 10mA \leq I_{OUT} \leq 3A$	1.764	1.8	1.830	V
	UZ1085-25	$4.0V \leq V_{IN} \leq 9.5V, 10mA \leq I_{OUT} \leq 3A$	2.450	2.5	2.550	V
	UZ1085-33	$4.8V \leq V_{IN} \leq 10.3V, 10mA \leq I_{OUT} \leq 3A$	3.234	3.3	3.366	V
	UZ1085-50	$6.5V \leq V_{IN} \leq 12V, 10mA \leq I_{OUT} \leq 3A$	4.900	5.0	5.100	V
Line Regulation	$\Delta V_{OUT}$	$(V_{OUT} + 1.5V) \leq V_{IN} \leq 12V, I_{OUT} = 10mA$		0.005	0.2	%
Load Regulation	$\Delta V_{OUT}$	$(V_{IN} - V_{OUT}) = 3V, 10mA \leq I_{OUT} \leq 3A$		0.05	0.5	%
Dropout Voltage	$V_D$	$\Delta V_{REF} \% = 1\%, I_{OUT} = 3A$		1.30	1.40	V
Current Limit	$I_{LIMIT}$	$(V_{IN} - V_{OUT}) = 2V$	3.1	4		A
Minimum Load Current	$I_{O(MIN)}$	$1.5V \leq (V_{IN} - V_{OUT}) \leq 12V$			10	mA
Quiescent Current	$I_Q$	$V_{IN} = 12V$		4	13	mA
Ripple Rejection	RR	$f = 120Hz, \text{Tantalum}$ $(V_{IN} - V_{OUT}) = 3V, I_{OUT} = 3A$	60	72		dB
Thermal Regulation		$T_a = 25^\circ C, 30ms \text{ pulse}$		0.004	0.02	%/W
Temperature Stability	$\Delta V_{OUT}$	$T_a = 125^\circ C, 1000hr$		0.5		%
Long-Term Stability	$\Delta V_{OUT}$			0.03	1.0	%
Output Noise(% of $V_{OUT}$ )	eN	$T_a = 25^\circ C, 10Hz \leq f \leq 10kHz$		0.003		%
Thermal shutdown				150		$^\circ C$

## ■ TYPICAL APPLICATION CIRCUIT

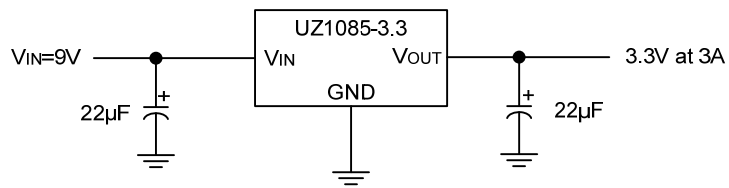
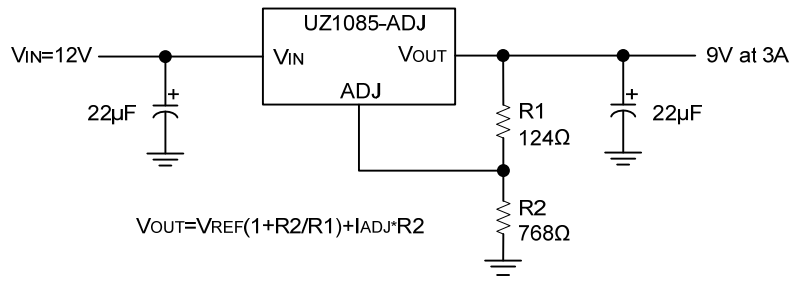

## TYPICAL CHARACTERISTICS

Figure 1. Absolute Maximum Safe Operating Area

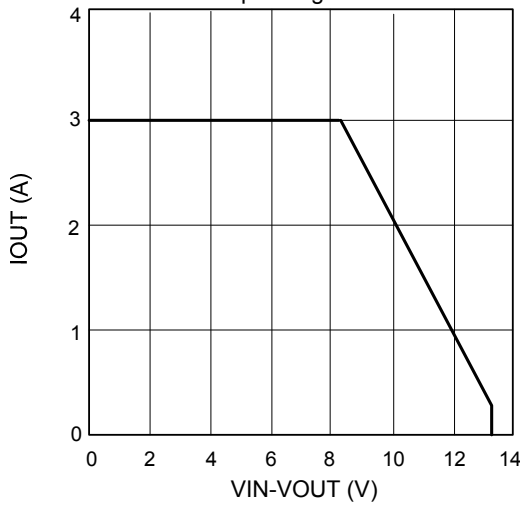

Figure 2. Dropout Voltage vs. Output Current

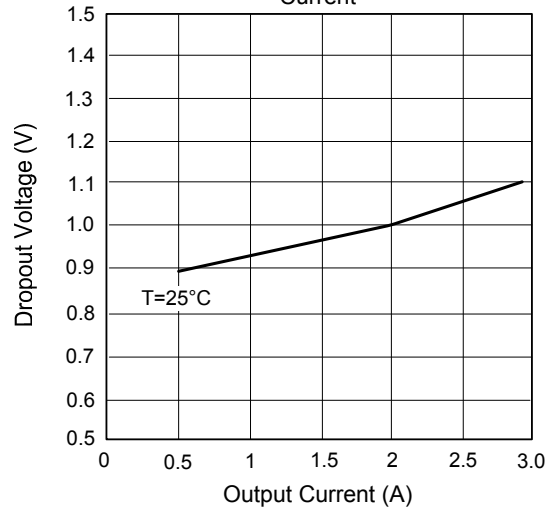

Figure 3. Load Regulation vs. Temperature

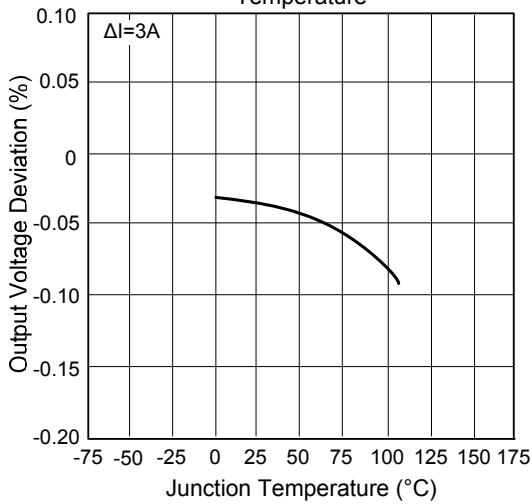

Figure 4. Reference Voltage vs. Temperature

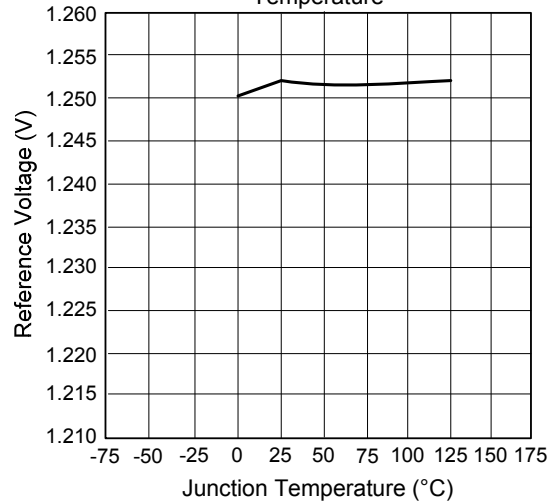

Figure 5. Output Voltage vs. Temperature

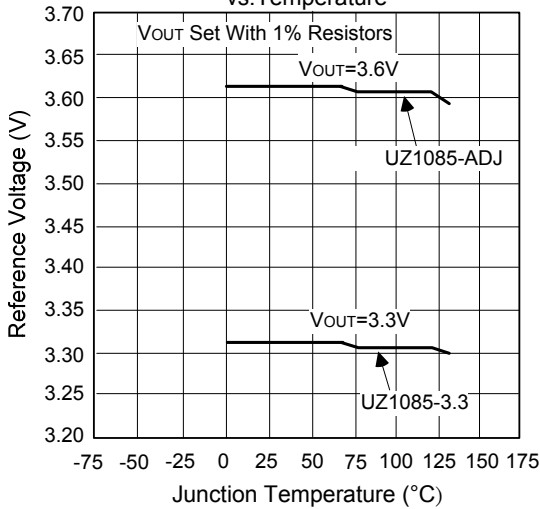
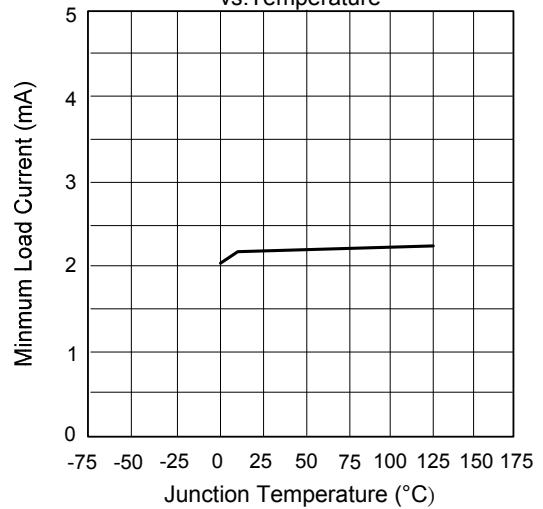

Figure 6. Minimum Load Current vs. Temperature



■ TYPICAL CHARACTERISTICS(Cont.)

Figure 7. Adjust Pin Current vs. Temperature

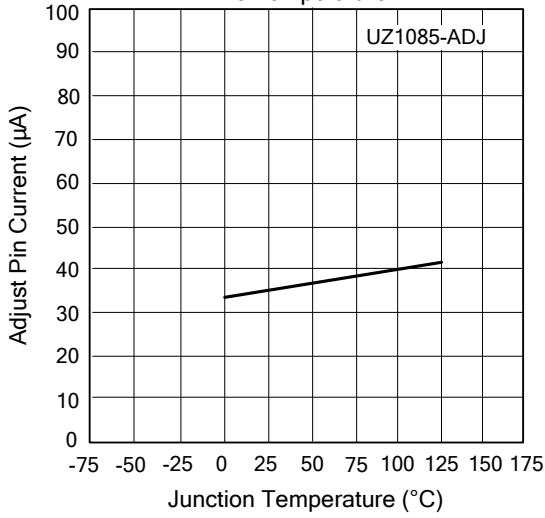

Figure 8. Short-Circuit Current vs. Temperature

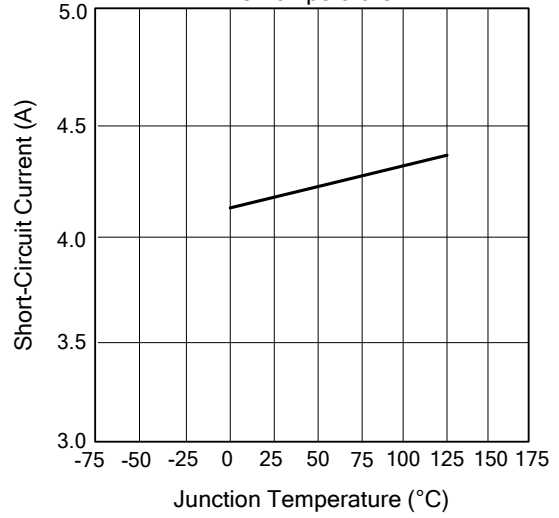

Figure 9. Ripple Rejection vs. Frequency

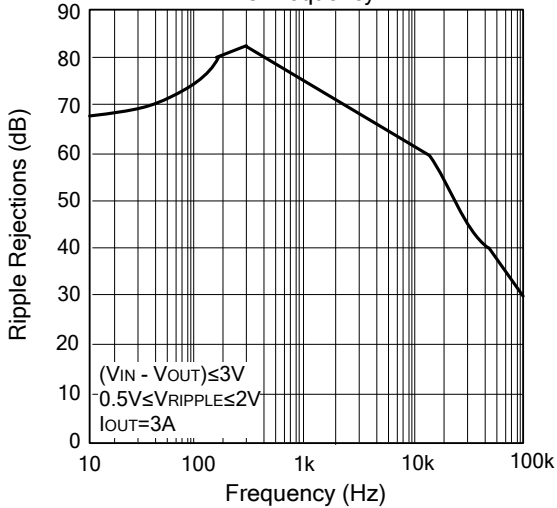
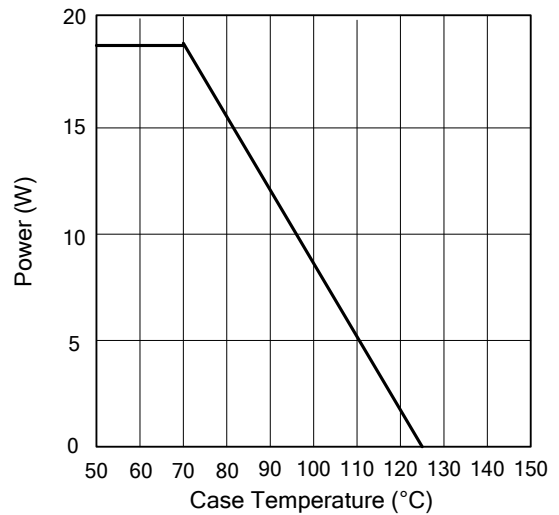

Figure 10. Maximum Power Dissipation



UTC assumes no responsibility for equipment failures that result from using products at values that exceed, even momentarily, rated values (such as maximum ratings, operating condition ranges, or other parameters) listed in products specifications of any and all UTC products described or contained herein. UTC products are not designed for use in life support appliances, devices or systems where malfunction of these products can be reasonably expected to result in personal injury. Reproduction in whole or in part is prohibited without the prior written consent of the copyright owner. The information presented in this document does not form part of any quotation or contract, is believed to be accurate and reliable and may be changed without notice.