

Single Phase Rectifier Bridge

$I_{dAV} = 38 \text{ A}$
 $V_{RRM} = 800-1600 \text{ V}$

Standard and Avalanche Types

V_{RSM} V	V_{BRmin} ① V	V_{RRM} V	Standard Types	Avalanche Types
900		800	VBO 25-08NO2	
1300	1230	1200	VBO 25-12NO2	VBO 25-12AO2
1700	1630	1600	VBO 25-16NO2	VBO 25-16AO2

① For Avalanche Types only

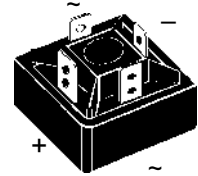
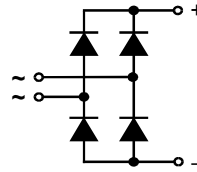

Symbol	Test Conditions	Maximum Ratings	
I_{dAV} ②	$T_C = 85^\circ\text{C}$, module	38 A	
I_{dAVM}	module	40 A	
P_{RSM}	$T_{VJ} = T_{VJM}$ $t = 10 \mu\text{s}$	3.4 kW	
I_{FSM}	$T_{VJ} = 45^\circ\text{C}$; $V_R = 0$	$t = 10 \text{ ms}$ (50 Hz), sine	370 A
		$t = 8.3 \text{ ms}$ (60 Hz), sine	390 A
I^2t	$T_{VJ} = 45^\circ\text{C}$; $V_R = 0$	$T_{VJ} = T_{VJM}$ $t = 10 \text{ ms}$ (50 Hz), sine	320 A
		$T_{VJ} = T_{VJM}$ $t = 8.3 \text{ ms}$ (60 Hz), sine	340 A
T_{VJ}	$T_{VJ} = 45^\circ\text{C}$; $V_R = 0$	$t = 10 \text{ ms}$ (50 Hz), sine	680 A ² s
		$t = 8.3 \text{ ms}$ (60 Hz), sine	640 A ² s
T_{VJM}	$T_{VJ} = T_{VJM}$ $t = 10 \text{ ms}$ (50 Hz), sine		510 A ² s
		$T_{VJ} = T_{VJM}$ $t = 8.3 \text{ ms}$ (60 Hz), sine	470 A ² s
T_{stg}	$T_{VJ} = 45^\circ\text{C}$; $V_R = 0$		-40...+150 °C
			150 °C
V_{ISOL}	50/60 Hz, RMS $t = 1 \text{ min}$ $I_{ISOL} \leq 1 \text{ mA}$ $t = 1 \text{ s}$		-40...+125 °C
			3000 V~
M_d	Mounting torque (M5) (10-32 UNF)		3600 V~
			1.5-2 Nm
Weight	typ.		13-18 lb.in.
			15 g

Features

- Avalanche rated parts available
- Package with DCB ceramic base plate
- Isolation voltage 3600 V~
- Planar passivated chips
- Low forward voltage drop
- 1/4" fast-on terminals
- UL registered E 72873

Applications

- Supplies for DC power equipment
- Input rectifiers for PWM inverter
- Battery DC power supplies
- Field supply for DC motors

Advantages

- Easy to mount with one screw
- Space and weight savings
- Improved temperature and power cycling

Symbol	Test Conditions	Characteristic Values	
I_R	$V_R = V_{RRM}$; $V_R = V_{RRM}$	$T_{VJ} = 25^\circ\text{C}$	$\leq 0.3 \text{ mA}$
		$T_{VJ} = T_{VJM}$	$\leq 5 \text{ mA}$
V_F	$I_F = 55 \text{ A}$; $T_{VJ} = 25^\circ\text{C}$	$\leq 1.36 \text{ V}$	
V_{T0}	For power-loss calculations only	0.85 V	
r_T	$T_{VJ} = T_{VJM}$	8 mΩ	
R_{thJC}	per diode, DC current		2.8 K/W
		per module	0.7 K/W
R_{thJK}	per diode, DC current		3.2 K/W
		per module	0.8 K/W
d_s	Creeping distance on surface	13 mm	
d_A	Creepage distance in air ③	9.5 mm	
a	Max. allowable acceleration	50 m/s ²	

Data according to IEC 60747 and refer to a single diode unless otherwise stated

② for resistive load at bridge output, ③ with isolated fast-on tabs

IXYS reserves the right to change limits, test conditions and dimensions.

Dimensions in mm (1 mm = 0.0394")

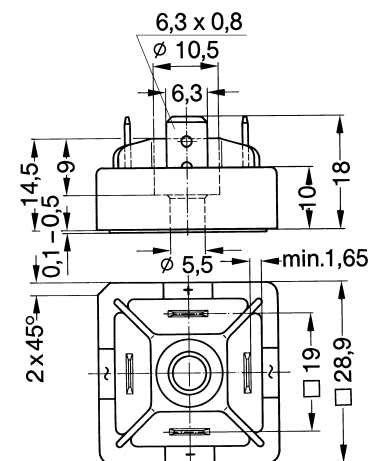

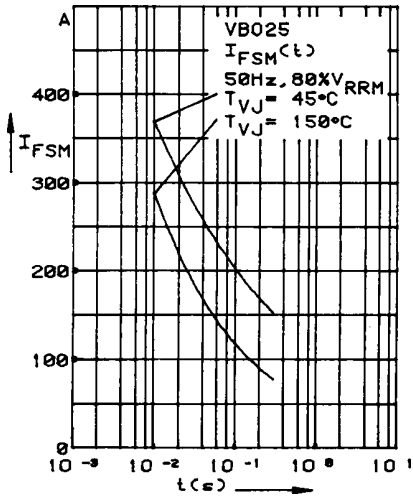

Fig. 1 Surge overload current per diode
 I_{FSM} : Crest value, t : duration

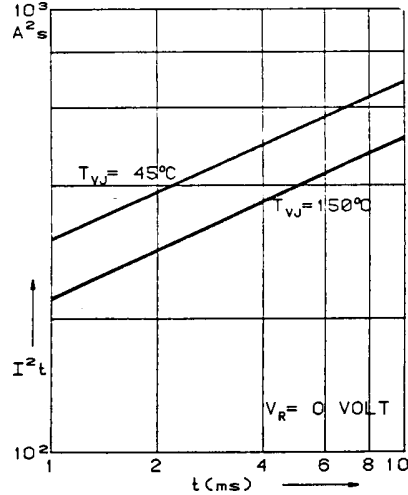

Fig. 2 I^2t versus time (1-10 ms) per diode

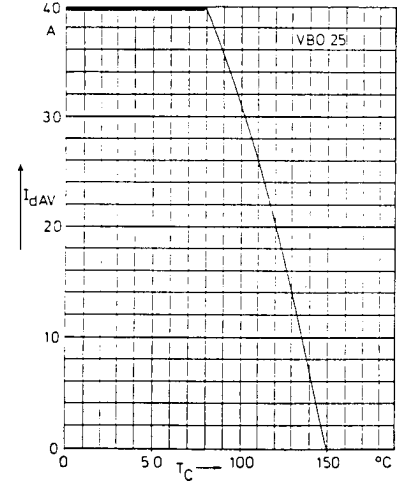

Fig. 3 Max. forward current at case temperature

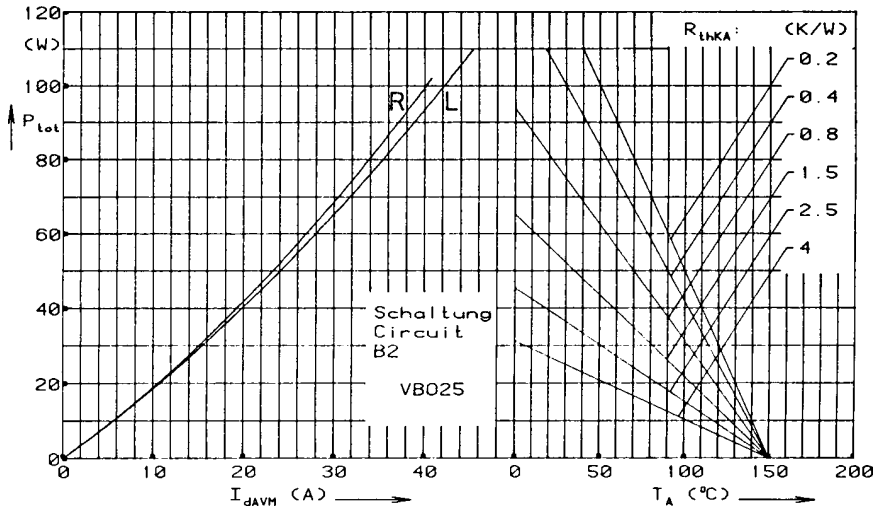

Fig. 4 Power dissipation versus direct output current and ambient temperature

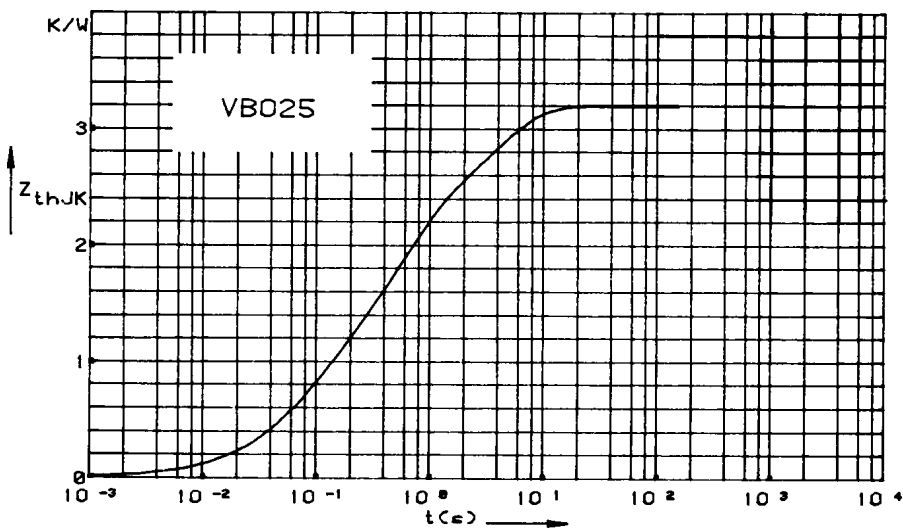

Fig. 5 Transient thermal impedance junction to heatsink per diode

Constants for Z_{thJK} calculation:

i	R_{thi} (K/W)	t_i (s)
1	0.775	0.0788
2	1.390	0.504
3	1.055	3.701