

## VCC6-Q/R Series

### 2.5 and 3.3 volt LVPECL Crystal Oscillator

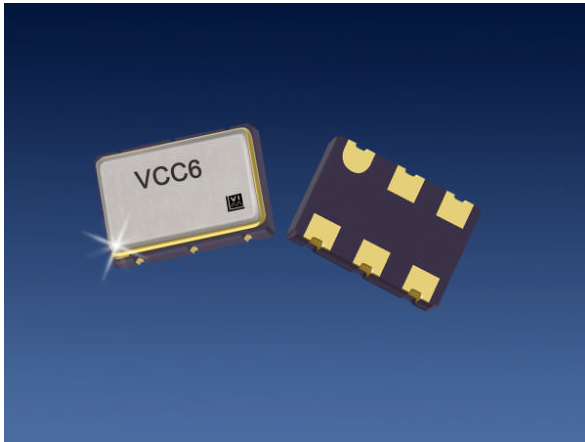

The VCC6 Crystal Oscillator

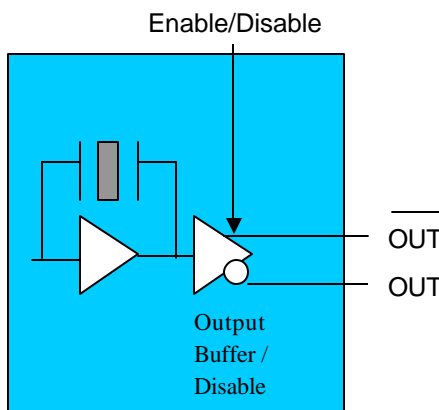

#### Features

- 2.5 or 3.3V LVPECL
- 3<sup>rd</sup> Overtone Crystal for best jitter performance
- Output frequencies to 270 MHz
- Low Jitter < 1 pS rms, 12kHz to 20MHz
- Enable/Disable for test and board debug
- -10/70 or -40/85 °C operating temperature
- Hermetically sealed ceramic SMD package

- Product is compliant to RoHS directive



#### Applications

- SONET/SDH/DWDM
- Fiber Channel
- Ethernet, Gigabit Ethernet
- Storage Area Network
- Digital Video
- Broadband Access

#### Description

Vectron's VCC6 Crystal Oscillator (XO) is quartz stabilized square wave generator with a LV-PECL output, operating off a 3.3 volt supply.

The VCC6 uses 3<sup>rd</sup> overtone crystals for frequencies under 200MHz, resulting in low jitter performance, typically 0.3pS rms in the 12 kHz to 20MHz band.

# VCC6-Q/R Series, 2.5 and 3.3v PECL Crystal Oscillator

## Performance Characteristics

**Table 1. Electrical Performance**

| Parameter   | Symbol               | Min                              | Typical                       | Maximum                          | Units        |
|---|----------------------|----------------------------------|-------------------------------|----------------------------------|--------------|
| Frequency   | $f_o$                | 10                               |                               | 270                              | MHz          |
| Supply Voltage <sup>1</sup> , 3.3V Q option<br>2.5V R option  | $V_{DD}$             | 3.15<br>2.375                    | 3.3<br>2.5                    | 3.45<br>2.625                    | V            |
| Supply Current  | $I_{DD}$             |                                  |                               | 98                               | mA           |
| Output Logic Levels, 0/70°C<br>Output Logic High <sup>2</sup><br>Output Logic Low <sup>2</sup>  | $V_{OH}$<br>$V_{OL}$ | $V_{DD}-1.025$<br>$V_{DD}-1.810$ |                               | $V_{DD}-0.880$<br>$V_{DD}-1.620$ | V<br>V       |
| Output Logic Levels, -40/85°C<br>Output Logic High <sup>2</sup><br>Output Logic Low <sup>2</sup>  | $V_{OH}$<br>$V_{OL}$ | $V_{DD}-1.085$<br>$V_{DD}-1.830$ |                               | $V_{DD}-0.880$<br>$V_{DD}-1.555$ | V<br>V       |
| Transition Times<br>Rise Time <sup>2</sup><br>Fall Time <sup>2</sup>  | $t_R$<br>$t_F$       |                                  |                               | 600<br>600                       | ps<br>ps     |
| Symmetry or Duty Cycle <sup>3</sup>   | SYM                  | 45                               | 50                            | 55                               | %            |
| Operating temperature (ordering option)   | $T_{OP}$             | -10/70 or -40/85                 |                               |                                  | °C           |
| Stability (ordering option) <sup>4</sup>  | $\Delta F/F$         | $\pm 25, \pm 50$ or $\pm 100$    |                               |                                  | ppm          |
| Jitter, 12kHz to 20MHz <sup>5</sup><br>Cycle to Cycle, rms<br>Cycle to Cycle, peak-peak<br>Period Jitter, rms<br>Period Jitter, peak-peak |                      |                                  | 0.3<br>4.8<br>38<br>2.7<br>23 | 0.7                              | ps           |
| Output Enabled <sup>6</sup>   | $V_{IH}$             | $0.7 \cdot V_{DD}$               |                               |                                  | V            |
| Output Disabled <sup>6</sup>  | $V_{IL}$             |                                  |                               | $0.3 \cdot V_{DD}$               | V            |
| Output Enable/Disable time  | $t_{E/D}$            |                                  |                               | 200                              | nS           |
| Enable/Disable Leakage Current  | $I_{IL}$             |                                  |                               | $\pm 200$                        | uA           |
| Output Enable Pull-Up Resistor <sup>6</sup><br>Output Enabled<br>Output Disabled  |                      |                                  | 33<br>1                       |                                  | Kohm<br>Mohm |

1. A 0.01uF and a 0.1uF capacitor should be located as close to the supply as possible and terminated to ground.
2. Figure 1 defines these parameters. Figure 2 illustrates the operating conditions under which these parameters are tested and specified.
3. Symmetry is measured defined as On Time/Period.
4. Includes calibration tolerance, operating temperature, supply voltage variations, aging (40 degreesC/10 years) and shock and vibration (not under operation).
5. Measurements made on a VCC6-QAB-155M520 using an Agilent E5052A for phase noise and LeCroy 8600, 25K samples for jitter.
6. Output will be enabled if Enable/Disable is left open. The pull resistor changes to a higher value, operating in a "power saving mode" when Enable/Disable is set to a logic 0.

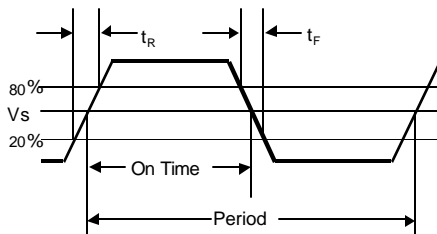

**Figure 1. Output Waveform**

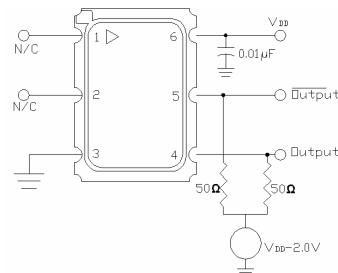

**Figure 2. Typical Output Test Conditions (25±5°C)**

# VCC6-Q/R Series, 2.5 and 3.3v PECL Crystal Oscillator

## Outline Diagram and Pin Out

Table 2. VCC6-QAx Pinout

| Pin # | Symbol   | Function   |
|-------|----------|--|
| 1     | NC       | This pin has no internal connection and is floating. |
| 2     | E/D      | Enable/Disable Function                              |
| 3     | GND      | Ground   |
| 4     | $f_o$    | Output Frequency                                     |
| 5     | $Cf_o$   | Complementary Output Frequency                       |
| 6     | $V_{DD}$ | Supply Voltage                                       |

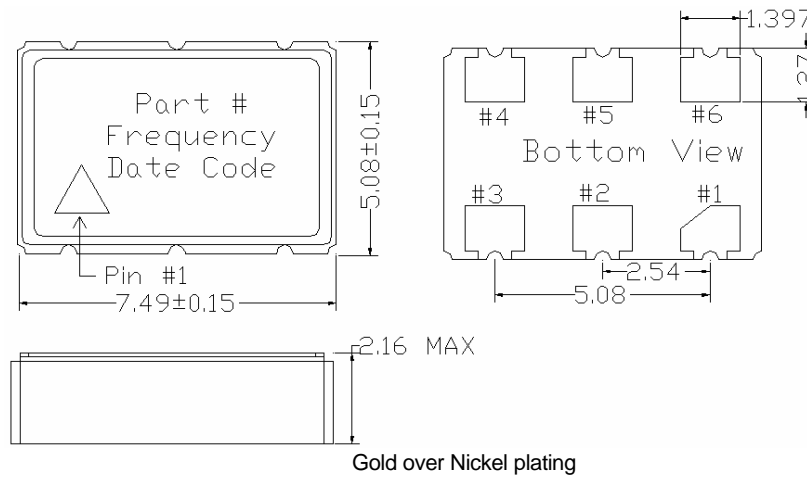

Figure 3 Optional VCC6-QAx Package Drawing

Table 3. VCC6-QCx Pinout

| Pin # | Symbol   | Function   |
|-------|----------|--|
| 1     | E/D      | Enable/Disable Function                              |
| 2     | NC       | This pin has no internal connection and is floating. |
| 3     | GND      | Ground   |
| 4     | $f_o$    | Output Frequency                                     |
| 5     | $Cf_o$   | Complementary Output Frequency                       |
| 6     | $V_{DD}$ | Supply Voltage                                       |

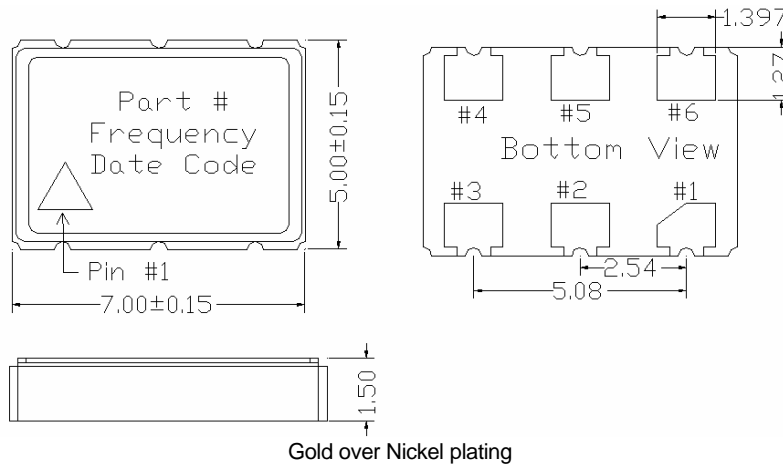

Figure 4. VCC6-QCx and VCC6-QAx Package Drawing

# VCC6-Q/R Series, 2.5 and 3.3v PECL Crystal Oscillator

## Terminating PECL Outputs

The VCC6 incorporates a standard PECL output scheme, which are un-terminated emitters as shown in Figure 5. There are numerous application notes on terminating and interfacing PECL logic and the two most common methods are a single resistor to ground, Figure 6, and a pull-up/pull-down scheme as shown in Figure 7. An AC coupling capacitor is optional, depending on the application and the input logic requirements of the next stage.

One of the most important considerations is terminating the Output and Complementary Outputs equally. An unused output should not be left un-terminated, and if it one of the two outputs is left open it will result in excessive jitter on both. PC board layout must take this and 50 ohm impedance matching into account. Load matching and power supply noise are the main contributors to jitter related problems.

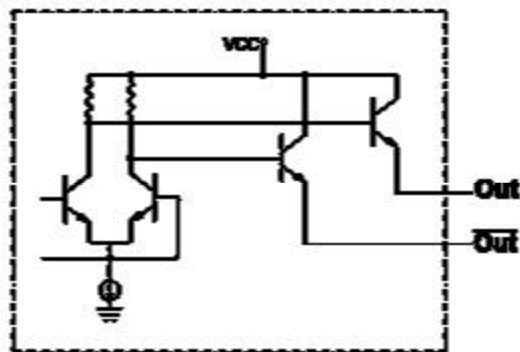
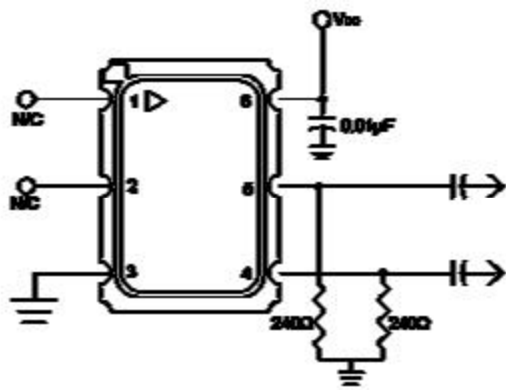
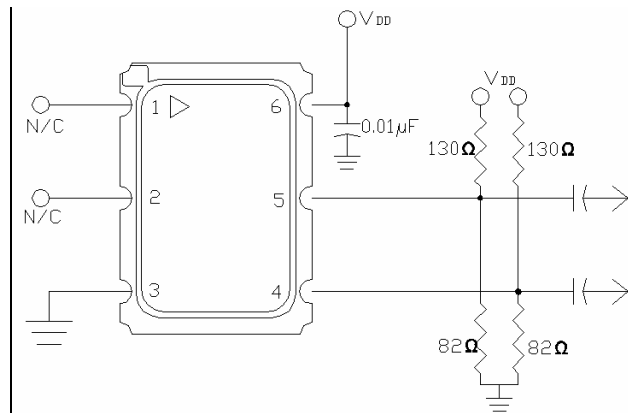

Figure 5. Standard PECL Output Configuration



**Figure 6. Single Resistor Termination**  
Resistor value are typically:  
120 to 240ohms for 3.3V  
82 to 120 ohms for 2.5V



**Figure 7. Pull-up Pull-down Termination**  
Resistor values are typically:  
130 and 82 ohms for 3.3V  
240 and 62 ohms for 2.5V

# VCC6-Q/R Series, 2.5 and 3.3v PECL Crystal Oscillator

## Enable/Disable Functional Description

Under normal operation the Enable/Disable is left open, or set to a logic high state, and the VCC6 is in oscillation mode and outputs are enabled (active). When the E/D is set to a logic low, the oscillator stops and the both the output and complementary outputs are in a high impedance state. This helps facilitate board testing and troubleshooting.

### Power Saving Pull-Up Resistor

The E/D pull-up resistor changes in response to the input logic level; the pull-up resistor is a large value when E/D is set to a logic low, which reduces the current consumed. When E/D is open, or set to a logic high, the pull-up resistance becomes a smaller value which helps decrease the effects of external noise.

## Absolute Maximum Ratings

Stresses in excess of the absolute maximum ratings can permanently damage the device. Functional operation is not implied at these or any other conditions in excess of conditions represented in the operational sections of this data sheet. Exposure to absolute maximum ratings for extended periods may adversely affect device reliability.

**Table 4. Absolute Maximum Ratings**

| Parameter           | Symbol               | Ratings                      | Unit |
|---------------------|----------------------|------------------------------|------|
| Power Supply        | V <sub>DD</sub>      | -0.5 to +7.0                 | Vdc  |
| Enable/Disable      | V <sub>IN</sub>      | -0.5 to V <sub>DD</sub> +0.5 | Vdc  |
| Storage Temperature | T <sub>storage</sub> | -55/125                      | °C   |

## Reliability

The VCC6 qualification tests included:

**Table 5. Environmental Compliance**

| Parameter              | Conditions              |
|------------------------|-------------------------|
| Mechanical Shock       | MIL-STD-883 Method 2002 |
| Mechanical Vibration   | MIL-STD-883 Method 2007 |
| Solderability          | MIL-STD-883 Method 2003 |
| Gross and Fine Leak    | MIL-STD-883 Method 1014 |
| Resistance to Solvents | MIL-STD-883 Method 2016 |

## Handling Precautions

Although ESD protection circuitry has been designed into the the VCC6, proper precautions should be taken when handling and mounting. VI employs a Human Body Model and a Charged-Device Model (CDM) for ESD susceptibility testing and design protection evaluation. ESD thresholds are dependent on the circuit parameters used to define the model. Although no industry wide standard has been adopted for the CDM, a standard HBM of resistance = 1.5kohms and capacitance = 100pF is widely used and therefore can be used for comparison purposes.

**Table 6. ESD Ratings**

| Model                | Minimum | Conditions              |
|----------------------|---------|-------------------------|
| Human Body Model     | 1500    | MIL-STD-883 Method 3015 |
| Charged Device Model | 1000    |                         |

# VCC6-Q/R Series, 2.5 and 3.3v PECL Crystal Oscillator

## IR Reflow and Suggested Pad Size Layout

The VCC6 has been qualified to meet the JEDEC standard for Pb-Free assembly. The temperatures and time intervals listed are based on the Pb-Free small body requirements and maximum parameters are listed in Table 6, lower temperatures are also acceptable. The VCC6 is hermetically sealed so an aqueous wash is not an issue. **Frequencies >200MHz will need to be reflowed at 220C max.**

| Table 7. Reflow Profile (IPC/JEDEC J-STD-020B) |             |                         |
|--|-------------|-------------------------|
| Parameter                                      | Symbol      | Value                   |
| PreHeat Time                                   | $t_s$       | 60 sec Min, 200 sec Max |
| Ramp Up  | $R_{UP}$    | 3 °C/sec Max            |
| Time Above 217 °C                              | $t_L$       | 60 sec Min, 150 sec Max |
| Time To Peak Temperature                       | $t_{AMB-P}$ | 480 sec Max             |
| Time At 260 °C (max)                           | $t_P$       | 10 sec Max              |
| Time At 240°C (max)                            | $tp2$       | 60 sec MAX              |
| Ramp Down                                      | $R_{DN}$    | 6 °C/sec Max            |

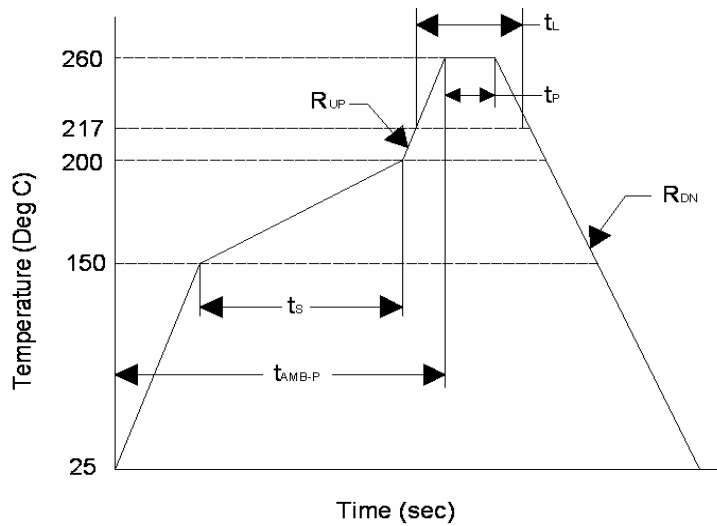

Figure 8. IR Reflow Diagram

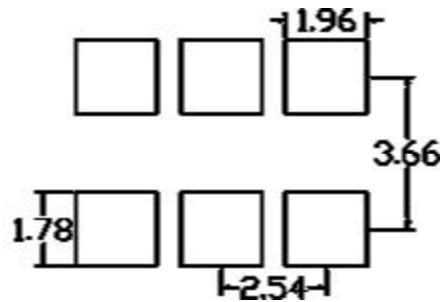

Figure 9. Pad Size Diagram

# VCC6-Q/R Series, 2.5 and 3.3v PECL Crystal Oscillator

## Tape and Reel

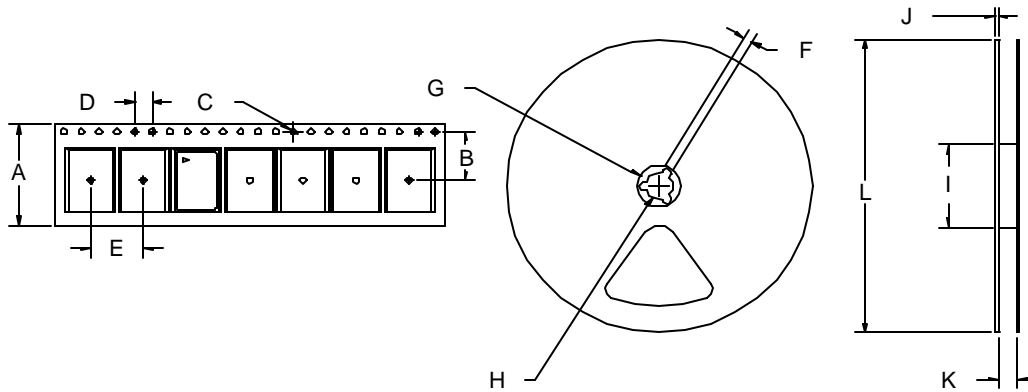

Figure 10. Tape and Reel Diagram

| Table 8. Tape and Reel Dimensions (mm) |    |     |     |   |   |                 |    |    |    |   |    |     |            |
|--|----|-----|-----|---|---|-----------------|----|----|----|---|----|-----|------------|
| Tape Dimensions                        |    |     |     |   |   | Reel Dimensions |    |    |    |   |    |     | # Per Reel |
| Product                                | A  | B   | C   | D | E | F               | G  | H  | I  | J | K  | L   |            |
| VCC6                                   | 16 | 7.5 | 1.5 | 4 | 8 | 2               | 21 | 13 | 60 | 2 | 17 | 180 | 250        |

## VCC6-Q/R Series, 2.5 and 3.3v PECL Crystal Oscillator

**Table 9. Standard Frequencies (MHz)**

|          |          |          |          |            |            |
|----------|----------|----------|----------|------------|------------|
| 19.440   | 27.000   | 27.027   | 35.000   | 37.000     | 38.880     |
| 40.000   | 40.680   | 48.000   | 50.000   | 52.300     | 62.500     |
| 64.000   | 64.375   | 74.1758  | 74.250   | 76.800     | 77.760     |
| 80.000   | 83.125   | 87.000   | 90.000   | 91.875     | 93.000     |
| 98.304   | 100.000  | 105.000  | 106.000  | 106.250    | 110.000    |
| 125.000  | 130.000  | 130.5882 | 133.000  | 134.560729 | 135.000    |
| 136.000  | 143.000  | 145.221  | 150.000  | 153.500    | 155.520    |
| 156.000  | 156.250  | 156.256  | 156.260  | 159.375    | 160.000    |
| 160.160  | 161.1328 | 163.235  | 164.3555 | 165.000    | 166.000    |
| 166.6286 | 166.6667 | 166.67   | 167.00   | 167.3316   | 168.200912 |
| 171.000  | 173.3707 | 175.000  | 180.000  | 187.500    | 190.000    |
| 195.3125 | 200.000  | 212.500  | 250.000  | 260.000    |            |

Other frequencies may be available upon request. Standard frequencies are frequencies which the crystal has been designed and does not imply a stock position.

### Ordering Information

## VCC6 – Qxx – xxxMxx

#### Product Family

Crystal Oscillator

#### Supply Voltage, Output

Q=3.3V, LVPECL

R=2.5V, LVPECL

#### Enable/Disable

A: E/D is on Pin 2, Pin 1 is a NC

C: E/D is on Pin 1, Pin 2 is a NC

#### Frequency MHz

example: 125M00= 125.000

#### Stability Options/Temperature

A: ±100ppm -10 to 70°C

B: ±50ppm -10 to 70°C

C: ±100ppm -40 to 85°C

D: ±50ppm -40 to 85°C

E: ±25ppm -10 to 70°C

F: ±25ppm -40 to 85°C

**NOTE:** Not all combinations of options are available.

A ±20ppm option over -10/70°C 3.3V, VCC6-107-frequency, is also available

A ±20ppm option over -10/70°C 2.5V, VCC6-110-frequency, is also available.

#### For Additional Information, Please Contact:



[www.vectron.com](http://www.vectron.com)

**USA:** Vectron International • 267 Lowell Road, Hudson, NH 03051

• Tel: 1-88-VECTRON-1 • Fax: 1-888-FAX-VECTRON

**EUROPE:** Landstrasse, D-74924, Neckarbischofsheim, Germany •

Tel: 49 (0) 7268 8010 • Fax: 49 (0) 7268 801281

**ASIA:** Vectron Asia Pacific Sales 1F~2F. No.8 Workshop No.308 Fenju Rd., WaiGaoQiao Free Trade Zone, Pudong New Area Shanghai, China 200131

•Tel: 8621 50480777 • Fax: 8621 50481881

Vectron International reserves the right to make changes to the product(s) and/or information contained herein without notice. No liability is assumed as a result of their use or application. No rights under any patent accompany the sale of any such product(s) or information.

VCC6-Q/R (REVISION DATE: September 07, 2005)