

6-Line ESD-Protection Diode Array in LLP75

Features

- Ultra compact LLP75-7A package
- 6-line ESD-protection
- Low leakage current $I_R < 1 \mu\text{A}$
- Low load capacitance $C_D = 40 \text{ pF}$
- ESD-immunity acc. IEC 61000-4-2
 - ± 30 kV contact discharge
 - ± 30 kV air discharge
- Working voltage range $V_{RWM} = 5 \text{ V}$
- Lead (Pb)-free component
- Component in accordance to RoHS 2002/95/EC and WEEE 2002/96/EC



RoHS
COMPLIANT
GREEN
(5-2008)*

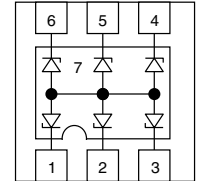
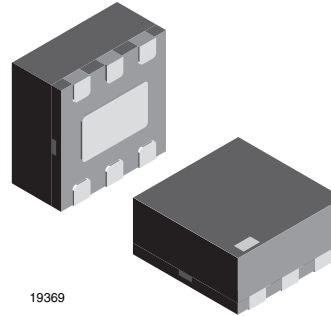

19371

19369

Marking (example only)

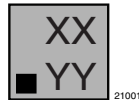

Dot = Pin 1 marking
XX = Date code
YY = Type code (see table below)

Ordering Information

Device name	Ordering code	Taped units per reel (8 mm tape on 7" reel)	Minimum order quantity
VESD05A6-HA3	VESD05A6-HA3-GS08	3000	15000

Package Data

Device name	Package name	Type code	Weight	Molding compound flammability rating	Moisture sensitivity level	Soldering conditions
VESD05A6-HA3	LLP75-7A	AF	5 mg	UL 94 V-0	MSL level 1 (according J-STD-020)	260 °C/10 s at terminals

* Please see document "Vishay Green and Halogen-Free Definitions (5-2008)" <http://www.vishay.com/doc?99902>

Absolute Maximum Ratings

Rating	Test condition	Symbol	Value	Unit
Peak pulse current	BiAs-Mode: each input (pin 1 - pin 6) to ground (pin 2); acc. IEC 61000-4-5; $t_p = 8/20 \mu s$; single shot	I_{PPM}	5	A
Peak pulse power	BiAs-mode: each input (pin 1 - pin 6) to ground (pin 2); acc. IEC 61000-4-5; $t_p = 8/20 \mu s$; single shot	P_{PP}	60	W
ESD immunity	Acc. IEC61000-4-2; 10 pulses BiAs-mode: each input (pin 1 - pin 6) to ground (pin 2)	Contact discharge	V_{ESD}	± 30 kV
		Air discharge	V_{ESD}	± 30 kV
Operating temperature	Junction temperature	T_J	- 40 to + 125	$^{\circ}C$
Storage temperature		T_{STG}	- 55 to + 150	$^{\circ}C$

Application Note:

- a) With the **VESD05A6-HA3** 6 different signal or data lines can be clamped to ground. Due to the different clamping levels in forward and reverse direction the **VESD05A6-HA3** clamping behavior is **B**idirectional and **A**symmetrical (**BiAs**).

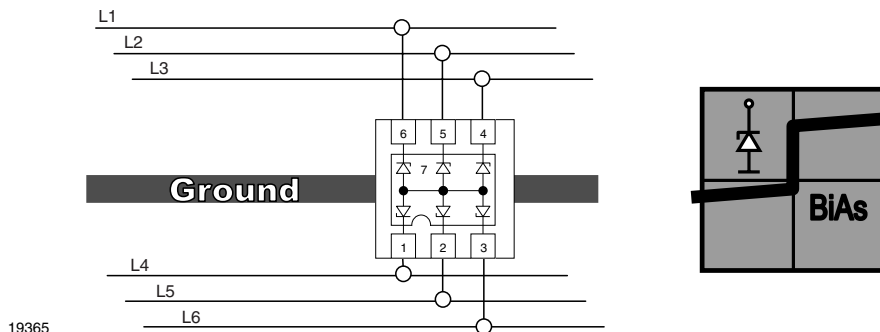

- b) If symmetrical clamping behaviour is required the **VESD05A6-HA3** can also be used as a **B**idirectional **S**ymmetrical protection device protecting up to 5 lines. In this case pin no. 7 must not be connected.

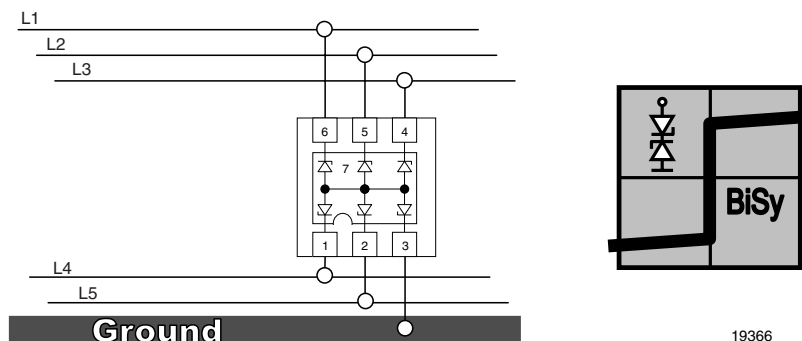

Electrical Characteristics

Ratings at 25 °C, ambient temperature unless otherwise specified

VESD05A6-HA3

BiAs mode (between pin 1, 2, 3, 4, 5 or 6 and pin 7)

Parameter	Test conditions/remarks	Symbol	Min.	Typ.	Max.	Unit
Protection paths	Number of lines which can be protected	N_{lines}			6	lines
Reverse stand off voltage	at $I_R = 1 \mu A$	V_{RWM}	5			V
Max. reverse current	at $V_R = 5 V$	I_R		< 0.1	1	μA
Reverse break down voltage	at $I_R = 1 mA$	V_{BR}	6	6.6	7.5	V
Reverse clamping voltage	at $I_{PP} = 1 A$	V_C		8.1	10	V
	at $I_{PP} = I_{PPM} = 5 A$	V_C		11.3	12	V
Forward clamping voltage	at $I_{PP} = 1 A$	V_F		1.5	1.8	V
	at $I_{PP} = I_{PPM} = 5 A$	V_F		3.2	4.5	V
Line capacitance	at $V_R = 0 V$; $f = 1 MHz$	C_D		40	50	pF
	at $V_R = 2.5 V$; $f = 1 MHz$	C_D		24		pF

Typical Characteristics

$T_{amb} = 25 \text{ }^\circ\text{C}$, unless otherwise specified

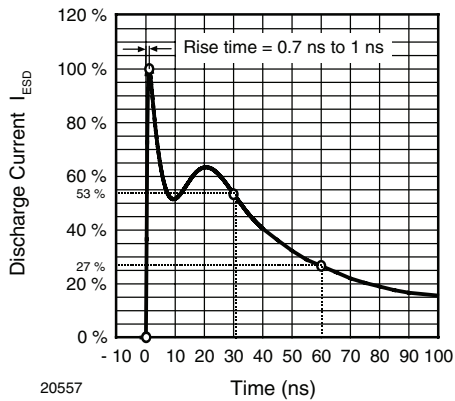

Figure 1. ESD Discharge Current Wave Form
acc. IEC 61000-4-2 (330 Ω /150 pF)

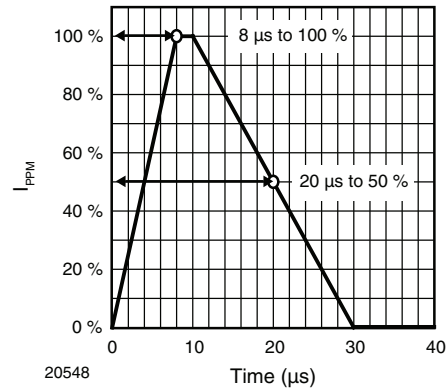

Figure 2. 8/20 μs Peak Pulse Current Wave Form
acc. IEC 61000-4-5

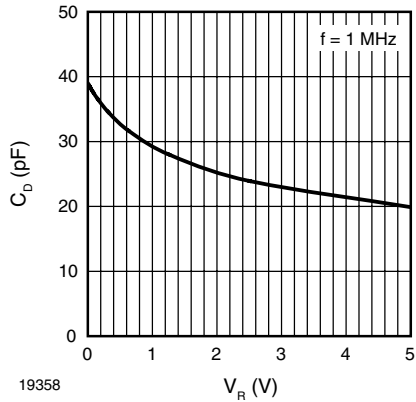

Figure 3. Typical Capacitance C_D vs. Reverse Voltage V_R

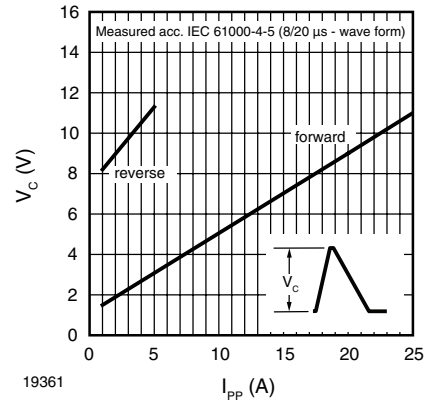

Figure 6. Typical Clamping Voltage vs. Peak Pulse Current I_{PP}

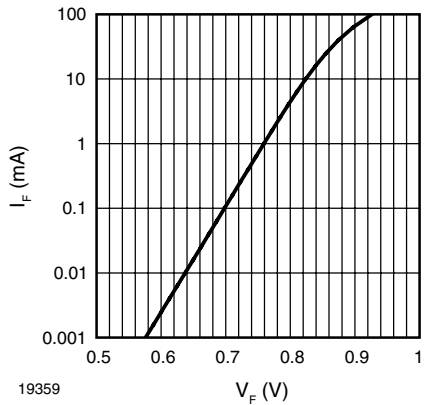

Figure 4. Typical Forward Current I_F vs. Forward Voltage V_F

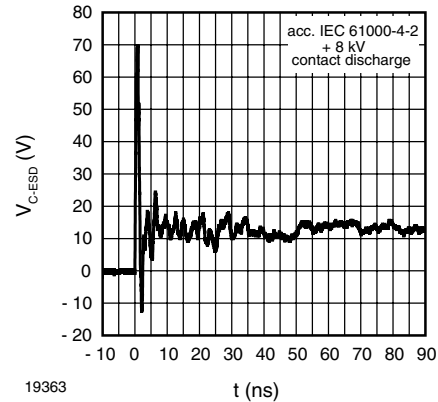

Figure 7. Typical Clamping Performance on +8 kV - ESD Events (acc. IEC 61000-4-2)

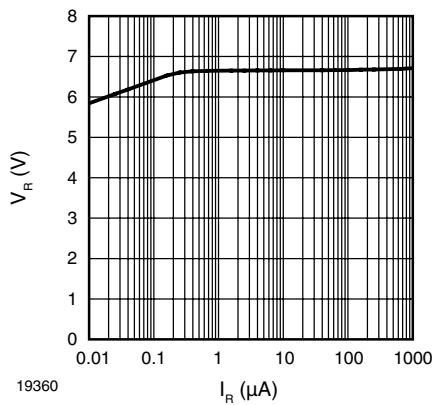

Figure 5. Typical Reverse Voltage V_R vs. Reverse Current I_R

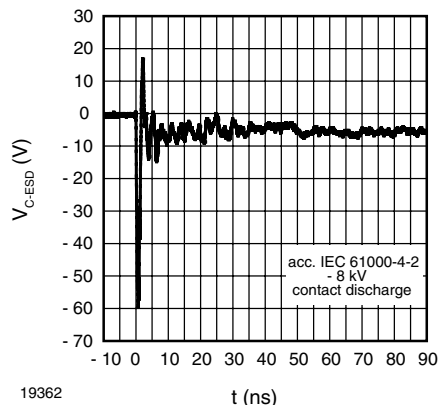

Figure 8. Typical Clamping Performance on -8 kV - ESD Events (acc. IEC 61000-4-2)

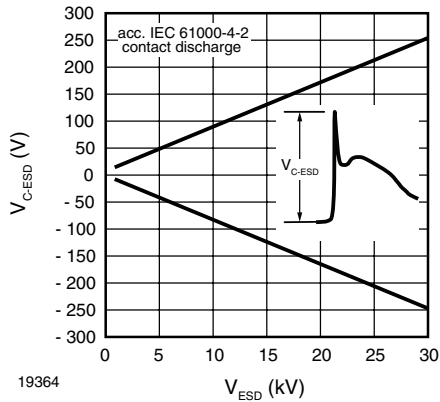
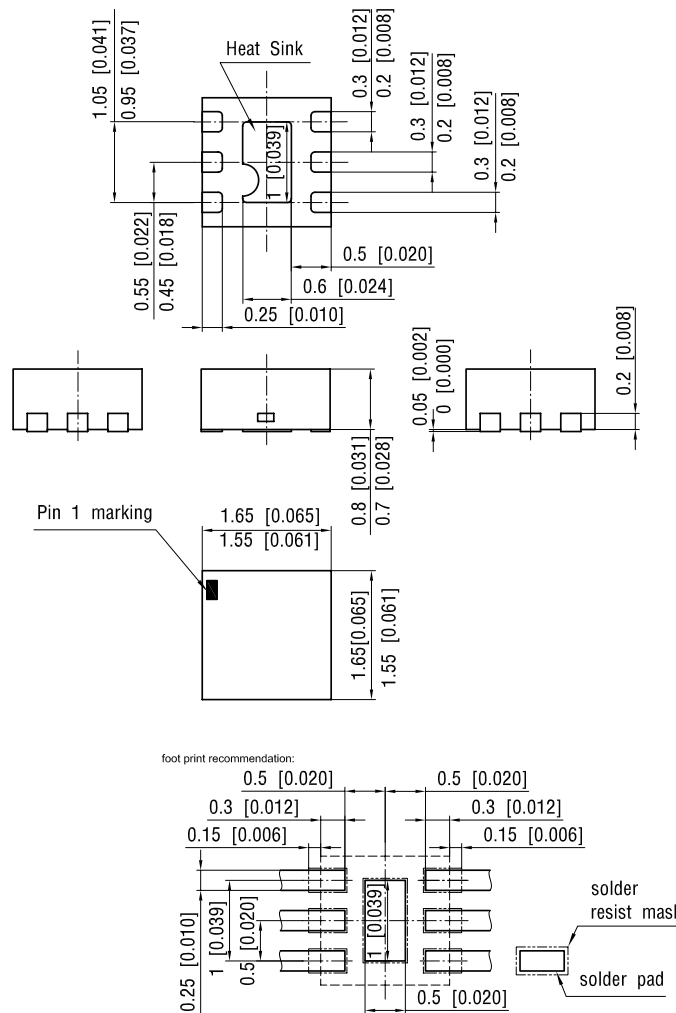

Figure 9. Typical max. Clamping Voltage at ESD Contact Discharge (acc. IEC 61000-4-2)

Package Dimensions in millimeters (inches): LLP75-7A



Document no.:S8-V-3906.02-002 (4)
Created - Date: 20.December.2004
Rev. 3 - Date: 21.March.2006

20459

Ozone Depleting Substances Policy Statement

It is the policy of Vishay Semiconductor GmbH to

1. Meet all present and future national and international statutory requirements.
2. Regularly and continuously improve the performance of our products, processes, distribution and operating systems with respect to their impact on the health and safety of our employees and the public, as well as their impact on the environment.

It is particular concern to control or eliminate releases of those substances into the atmosphere which are known as ozone depleting substances (ODSs).

The Montreal Protocol (1987) and its London Amendments (1990) intend to severely restrict the use of ODSs and forbid their use within the next ten years. Various national and international initiatives are pressing for an earlier ban on these substances.

Vishay Semiconductor GmbH has been able to use its policy of continuous improvements to eliminate the use of ODSs listed in the following documents.

1. Annex A, B and list of transitional substances of the Montreal Protocol and the London Amendments respectively.
2. Class I and II ozone depleting substances in the Clean Air Act Amendments of 1990 by the Environmental Protection Agency (EPA) in the USA.
3. Council Decision 88/540/EEC and 91/690/EEC Annex A, B and C (transitional substances) respectively.

Vishay Semiconductor GmbH can certify that our semiconductors are not manufactured with ozone depleting substances and do not contain such substances.

We reserve the right to make changes to improve technical design
and may do so without further notice.

Parameters can vary in different applications. All operating parameters must be validated for each customer application by the customer. Should the buyer use Vishay Semiconductors products for any unintended or unauthorized application, the buyer shall indemnify Vishay Semiconductors against all claims, costs, damages, and expenses, arising out of, directly or indirectly, any claim of personal damage, injury or death associated with such unintended or unauthorized use.

Vishay Semiconductor GmbH, P.O.B. 3535, D-74025 Heilbronn, Germany



Disclaimer

All product specifications and data are subject to change without notice.

Vishay Intertechnology, Inc., its affiliates, agents, and employees, and all persons acting on its or their behalf (collectively, "Vishay"), disclaim any and all liability for any errors, inaccuracies or incompleteness contained herein or in any other disclosure relating to any product.

Vishay disclaims any and all liability arising out of the use or application of any product described herein or of any information provided herein to the maximum extent permitted by law. The product specifications do not expand or otherwise modify Vishay's terms and conditions of purchase, including but not limited to the warranty expressed therein, which apply to these products.

No license, express or implied, by estoppel or otherwise, to any intellectual property rights is granted by this document or by any conduct of Vishay.

The products shown herein are not designed for use in medical, life-saving, or life-sustaining applications unless otherwise expressly indicated. Customers using or selling Vishay products not expressly indicated for use in such applications do so entirely at their own risk and agree to fully indemnify Vishay for any damages arising or resulting from such use or sale. Please contact authorized Vishay personnel to obtain written terms and conditions regarding products designed for such applications.

Product names and markings noted herein may be trademarks of their respective owners.