



N-Channel Enhancement-Mode Vertical DMOS FETs

Ordering Information Standard Commercial Devices

BV _{DSS} / BV _{DGS}	R _{DS(ON)} (max)	I _{D(ON)} (min)	Order Number / Package
			TO-92
60V	5.0Ω	0.75A	VN10KN3

Features

- Free from secondary breakdown
- Low power drive requirement
- Ease of paralleling
- Low C_{ISS} and fast switching speeds
- Excellent thermal stability
- Integral Source-Drain diode
- High input impedance and high gain
- Complementary N- and P-channel devices

Applications

- Motor controls
- Converters
- Amplifiers
- Switches
- Power supply circuits
- Drivers (relays, hammers, solenoids, lamps, memories, displays, bipolar transistors, etc.)

Absolute Maximum Ratings

Drain-to-Source Voltage	BV _{DSS}
Drain-to-Gate Voltage	BV _{DGS}
Gate-to-Source Voltage	± 30V
Operating and Storage Temperature	-55°C to +150°C
Soldering Temperature*	300°C

* Distance of 1.6 mm from case for 10 seconds.

Advanced DMOS Technology

These enhancement-mode (normally-off) transistors utilize a vertical DMOS structure and Supertex's well-proven silicon-gate manufacturing process. This combination produces devices with the power handling capabilities of bipolar transistors and with the high input impedance and positive temperature coefficient inherent in MOS devices. Characteristic of all MOS structures, these devices are free from thermal runaway and thermally-induced secondary breakdown.

Supertex's vertical DMOS FETs are ideally suited to a wide range of switching and amplifying applications where high breakdown voltage, high input impedance, low input capacitance, and fast switching speeds are desired.

Package Option

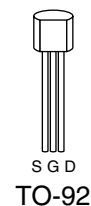

Note: See Package Outline section for dimensions.

Thermal Characteristics

Package	I_D (continuous) ^{1,2}	I_D (pulsed)	Power Dissipation @ $T_C = 25^\circ\text{C}$	θ_{jc} $^\circ\text{C/W}$	θ_{ja} $^\circ\text{C/W}$	I_{DR}	I_{DRM}
TO-92	0.31A	1.0A	1.0W	125	170	0.31A	1.0A

Notes:

- I_D (continuous) is limited by max rated T_j .
- VN0106N3 can be used if an I_D (continuous) of 0.5 is needed.

Electrical Characteristics (@ 25°C unless otherwise specified)

Symbol	Parameter	Min	Typ	Max	Unit	Conditions
BV_{DSS}	Drain-to-Source Breakdown Voltage	60			V	$V_{GS} = 0V, I_D = 100\mu\text{A}$
$V_{GS(th)}$	Gate Threshold Voltage	0.8		2.5	V	$V_{GS} = V_{DS}, I_D = 1\text{mA}$
$\Delta V_{GS(th)}$	Change in $V_{GS(th)}$ with Temperature		-3.8		mV/ $^\circ\text{C}$	$V_{GS} = V_{DS}, I_D = 1\text{mA}$
I_{GSS}	Gate Body Leakage			100	nA	$V_{GS} = 15V, V_{DS} = 0V$
I_{DSS}	Zero Gate Voltage Drain Current			10	μA	$V_{GS} = 0V, V_{DS} = 45V$
				500	μA	$V_{GS} = 0V, V_{DS} = 45V, T_A 125^\circ\text{C}$
$I_{D(ON)}$	ON-State Drain Current	0.75			A	$V_{GS} = 10V, V_{DS} = 10V$
$R_{DS(ON)}$	Static Drain-to-Source ON-State Resistance			7.5	Ω	$V_{GS} = 5V, I_D = 0.2A$
				5.0	Ω	$V_{GS} = 10V, I_D = 500\text{mA}$
$\Delta R_{DS(th)}$	Change in $R_{DS(th)}$ with Temperature		0.7		%/ $^\circ\text{C}$	$V_{GS} = 10V, I_D = 500\text{mA}$
G_{FS}	Forward Transconductance	100			m Ω	$V_{DS} = 10V, I_D = 500\text{mA}$
C_{ISS}	Input Capacitance		48	60	pF	$V_{DS} = 25V, V_{GS} = 0V$ $f = 1\text{MHz}$
C_{OSS}	Common Source Output Capacitance		16	25		
C_{RSS}	Reverse Transfer Capacitance		2	5		
$t_{(ON)}$	Turn-ON Time			10	ns	$V_{DD} = 15V, I_D = 0.6A,$ $R_{GEN} = 25\Omega$
$t_{(OFF)}$	Turn-OFF Time			10		
V_{SD}	Diode Forward Voltage Drop		0.8		V	$V_{GS} = 0V, I_{SD} = 0.5A$
t_{rr}	Reverse Recovery Time		160		ns	$V_{GS} = 0V, I_{SD} = 0.5A$

Notes:

- All D.C. parameters 100% tested at 25°C unless otherwise stated. (Pulse test: 300 μs pulse, 2% duty cycle.)
- All A.C. parameters sample tested.

Switching Waveforms and Test Circuit

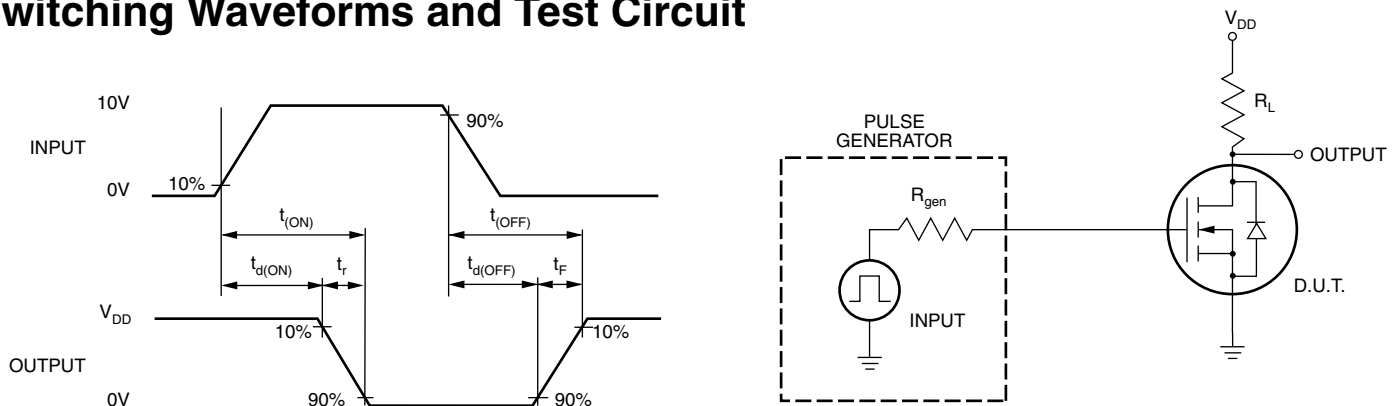

Typical Performance Curves

Output Characteristics

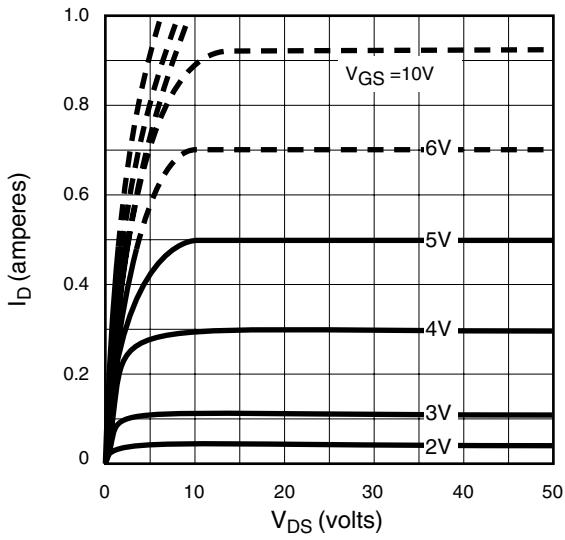

Saturation Characteristics

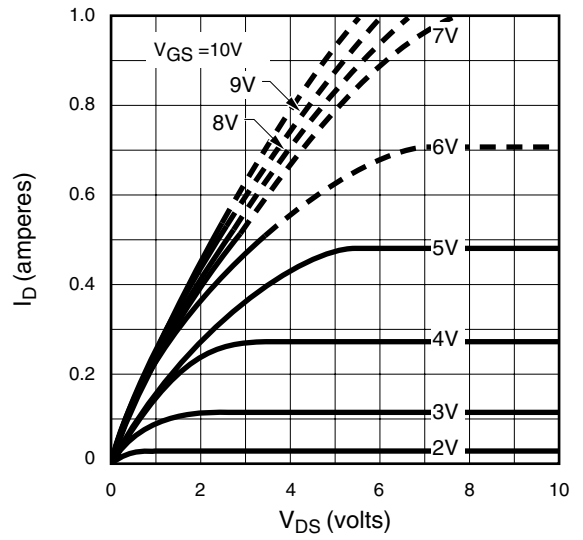

Transconductance vs. Drain Current

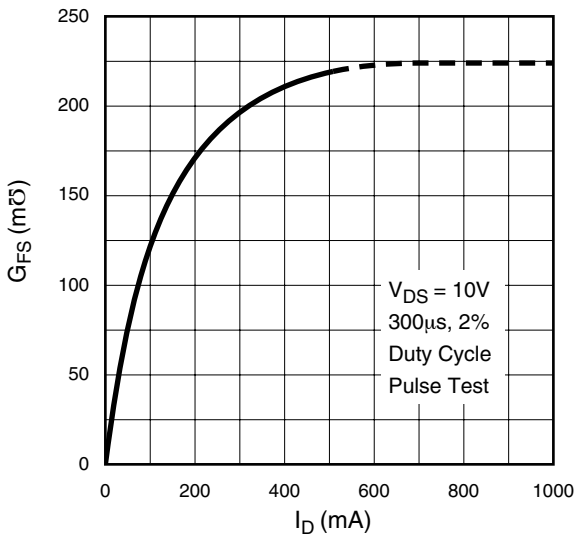

Power Dissipation vs. Case Temperature

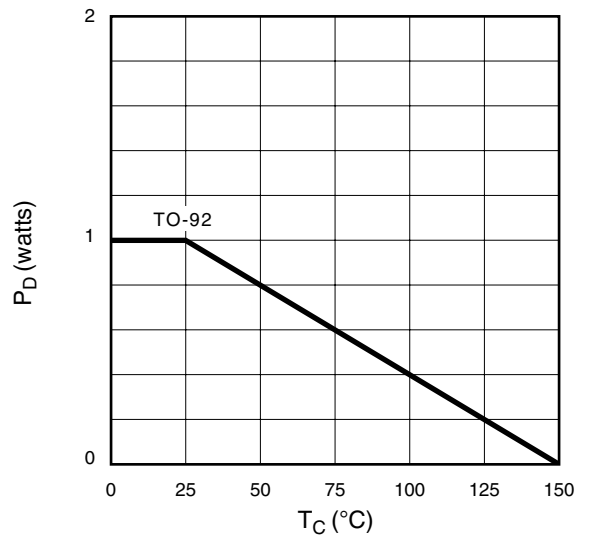

Maximum Rated Safe Operating Area

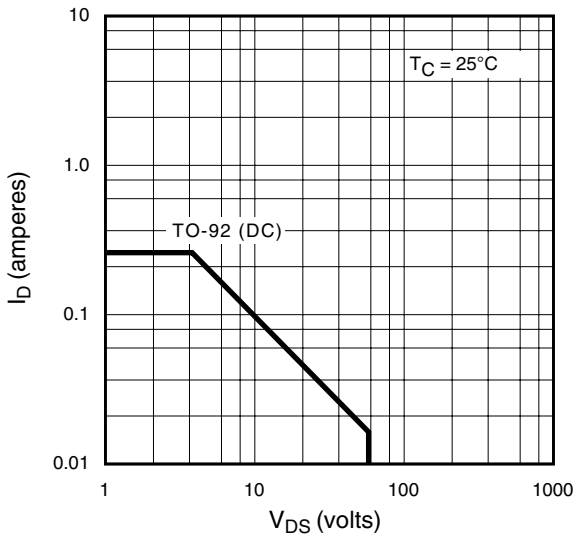

Switching Waveform

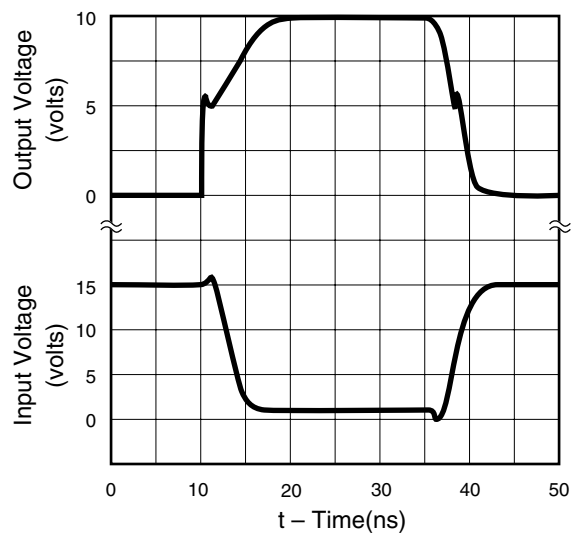

Typical Performance Curves

BV_{DSS} Variation with Temperature

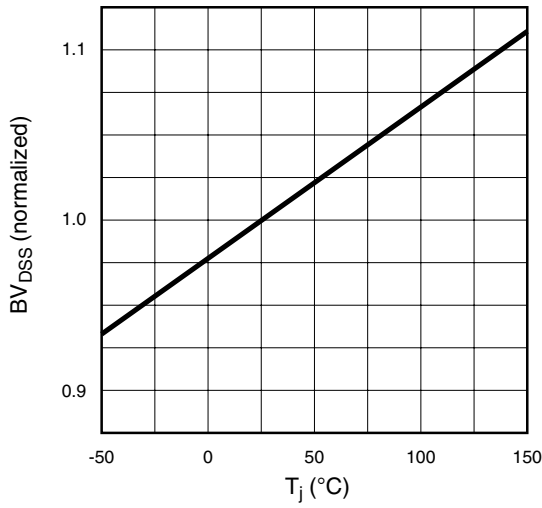

On-Resistance vs. Gate-to-Source Voltage

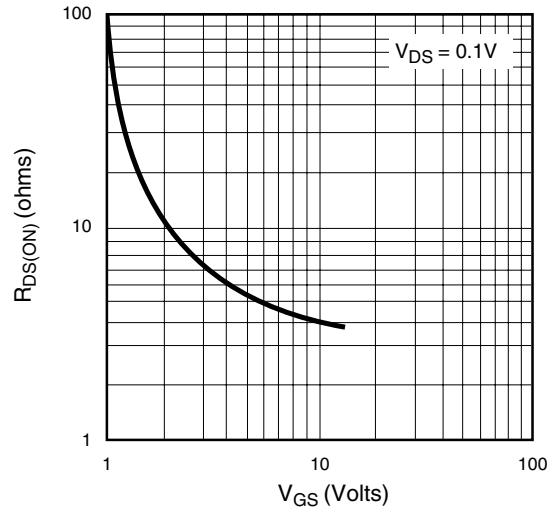

Transfer Characteristics

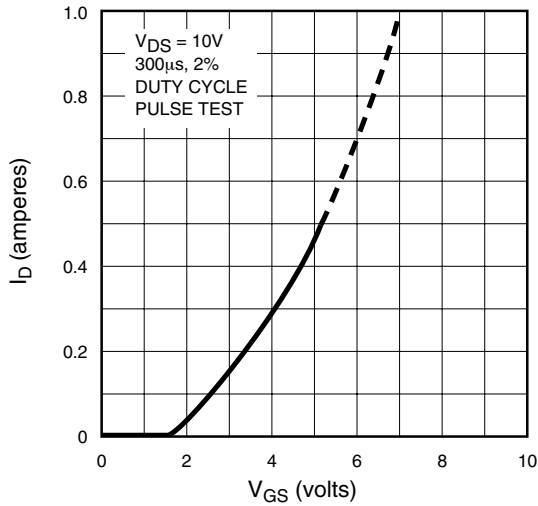

Output Conductance vs Drain Current

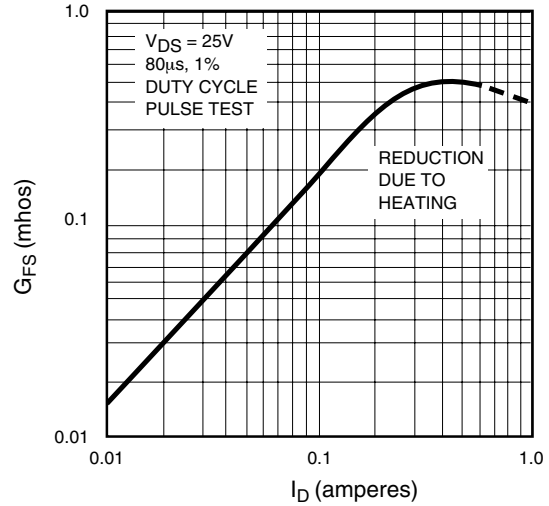

Capacitance vs. Drain-to-Source Voltage

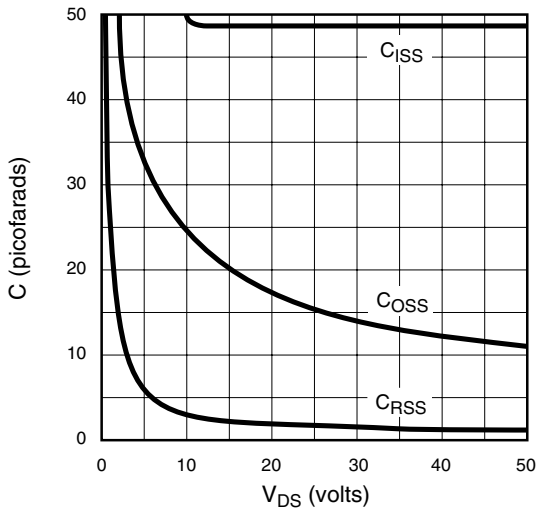

Transconductance vs Gate-Source Voltage

