



N-Channel Enhancement-Mode Vertical DMOS FETs

Ordering Information

BV _{DSS} / BV _{DGS}	R _{DS(ON)} (max)	I _{D(ON)} (min)	Order Number / Package		
			TO-92	TO-243AA*	Die**
600V	20Ω	0.25A	VN2460N3	VN2460N8	VN2460NW

* Same as SOT-89 Product Supplied on 2000 piece carrier tape reels.

** Die in wafer form.

Features

- Free from secondary breakdown
- Low power drive requirement
- Ease of paralleling
- Low C_{ISS} and fast switching speeds
- Excellent thermal stability
- Integral Source-Drain diode
- High input impedance and high gain

Applications

- Motor controls
- Converters
- Amplifiers
- Switches
- Power supply circuits
- Drivers (relays, hammers, solenoids, lamps, memories, displays, bipolar transistors, etc.)

Absolute Maximum Ratings

Drain-to-Source Voltage	BV _{DSS}
Drain-to-Gate Voltage	BV _{DGS}
Gate-to-Source Voltage	± 20V
Operating and Storage Temperature	-55°C to +150°C
Soldering Temperature*	300°C

* Distance of 1.6 mm from case for 10 seconds.

Product marking for TO-243AA:

VN4F*

Where * = 2-week alpha date code

Advanced DMOS Technology

These low threshold enhancement-mode (normally-off) transistors utilize a vertical DMOS structure and Supertex's well-proven silicon-gate manufacturing process. This combination produces devices with the power handling capabilities of bipolar transistors and with the high input impedance and positive temperature coefficient inherent in MOS devices. Characteristic of all MOS structures, these devices are free from thermal runaway and thermally-induced secondary breakdown.

Supertex's vertical DMOS FETs are ideally suited to a wide range of switching and amplifying applications where high breakdown voltage, high input impedance, low input capacitance, and fast switching speeds are desired.

Package Options

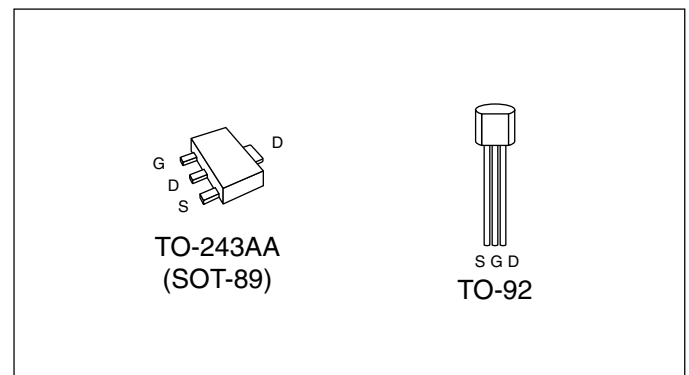

Note: See Package Outline section for dimensions.

Thermal Characteristics

Package	I_D (continuous)*	I_D (pulsed)	Power Dissipation @ $T_C = 25^\circ\text{C}$	θ_{jc} $^\circ\text{C/W}$	θ_{ja} $^\circ\text{C/W}$	I_{DR}^*	I_{DRM}
TO-243AA	0.2A	0.6A	1.6W [†]	15	78 [†]	0.2A	0.6A
TO-92	0.16A	0.5A	1W	125	170	0.16A	0.5A

* I_D (continuous) is limited by max rated T_j .

[†] Mounted on FR5 board, 25mm x 25mm x 1.57mm. Significant P_D increase possible on ceramic substrate.

Electrical Characteristics (@ 25°C unless otherwise specified)

Symbol	Parameter	Min	Typ	Max	Unit	Conditions
BV_{DSS}	Drain-to-Source Breakdown Voltage	600			V	$V_{GS} = 0V, I_D = 2.0mA$
$V_{GS(th)}$	Gate Threshold Voltage	1.5			V	$V_{GS} = V_{DS}, I_D = 2.0mA$
$\Delta V_{GS(th)}$	Change in $V_{GS(th)}$ with Temperature			-5.5	mV/ $^\circ\text{C}$	$V_{GS} = V_{DS}, I_D = 2.0mA$
I_{GSS}	Gate Body Leakage			100	nA	$V_{GS} = \pm 20V, V_{DS} = 0V$
I_{DSS}	Zero Gate Voltage Drain Current			10	μA	$V_{GS} = 0V, V_{DS} = \text{Max Rating}$
				1	mA	$V_{GS} = 0V, V_{DS} = 0.8 \text{ Max Rating}$ $T_A = 125^\circ\text{C}$
$I_{D(ON)}$	ON-State Drain Current	0.25			A	$V_{GS} = 10V, V_{DS} = 25V$
$R_{DS(ON)}$	Static Drain-to-Source ON-State Resistance			25	Ω	$V_{GS} = 4.5V, I_D = 100mA$
				20		$V_{GS} = 10V, I_D = 100mA$
$\Delta R_{DS(ON)}$	Change in $R_{DS(ON)}$ with Temperature			1.7	%/ $^\circ\text{C}$	$V_{GS} = 10V, I_D = 100mA$
G_{FS}	Forward Transconductance	50			m \bar{S}	$V_{DS} = 25V, I_D = 100mA$
C_{ISS}	Input Capacitance			150	μF	$V_{GS} = 0V, V_{DS} = 25V$ $f = 1.0 \text{ MHz}$
C_{OSS}	Common Source Output Capacitance			50		
C_{RSS}	Reverse Transfer Capacitance			25		
$t_{d(ON)}$	Turn-ON Delay Time			10	ns	$V_{DD} = 25V,$ $I_D = 250mA,$ $R_{GEN} = 25\Omega$
t_r	Rise Time			10		
$t_{d(OFF)}$	Turn-OFF Delay Time			25		
t_f	Fall Time			20		
V_{SD}	Diode Forward Voltage Drop			1.5	V	$V_{GS} = 0V, I_{SD} = 400mA$

Notes:

- All D.C. parameters 100% tested at 25°C unless otherwise stated. (Pulse test: 300 μs pulse, 2% duty cycle.)
- All A.C. parameters sample tested.

Switching Waveforms and Test Circuit

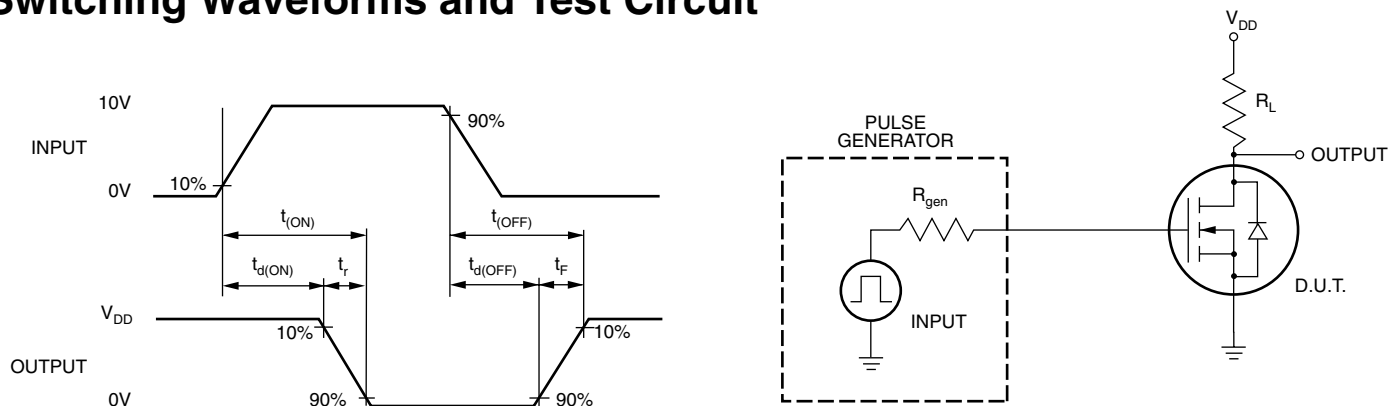

Typical Performance Curves

Output Characteristics

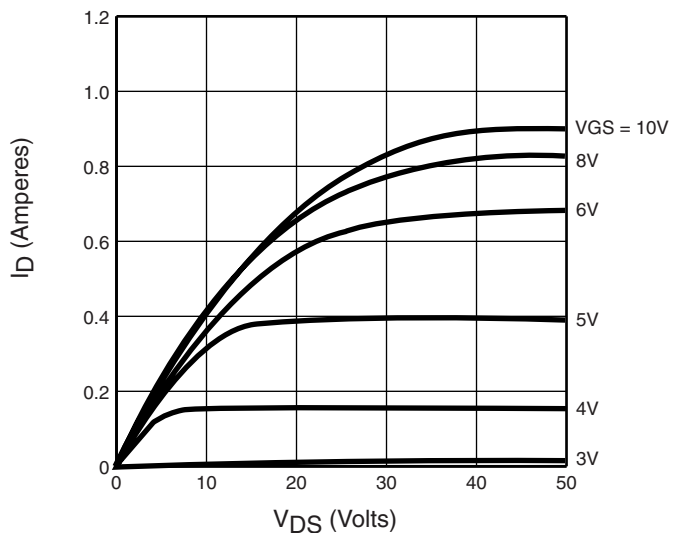

Saturation Characteristics

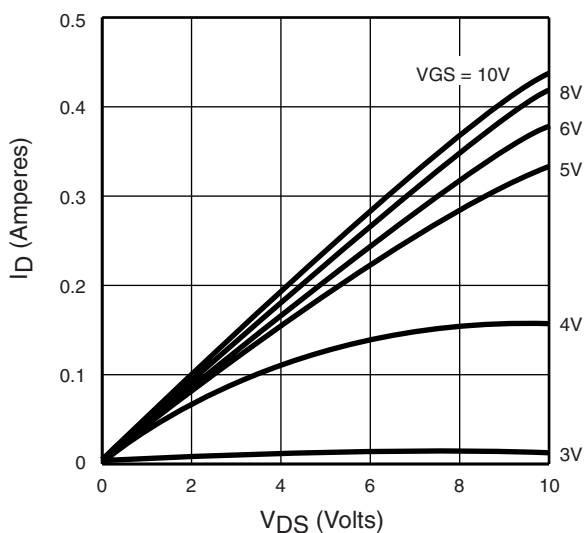

Transconductance vs. Drain Current

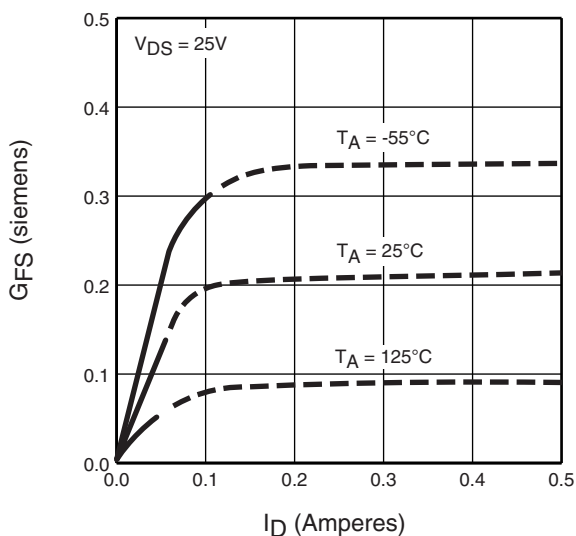

Power Dissipation vs. Case Temperature

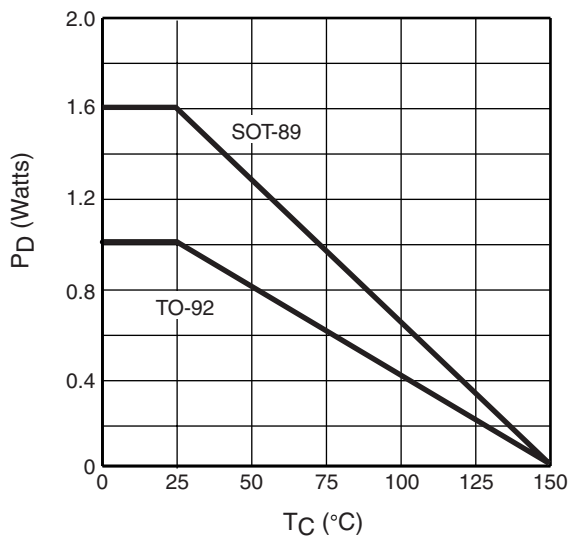

Maximum Rated Safe Operating Area

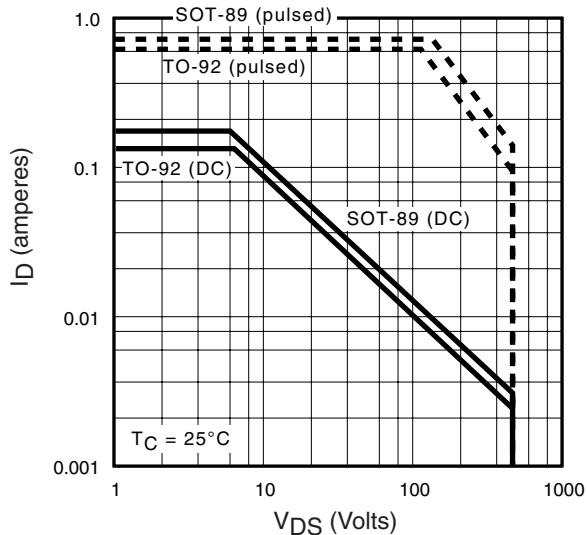

Thermal Response Characteristics

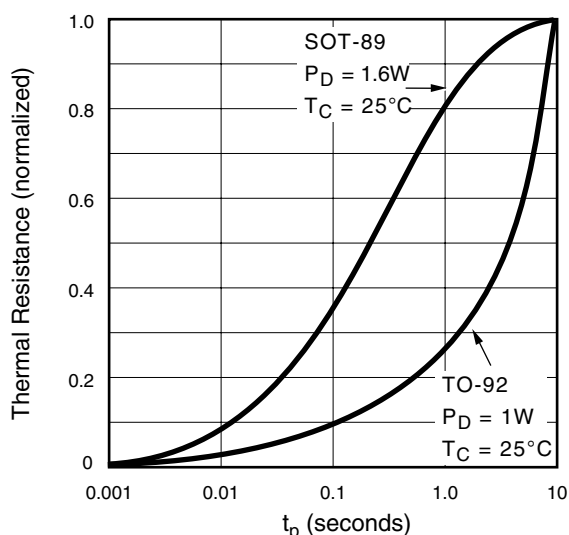

Typical Performance Curves

BV_{DSS} Variation with Temperature

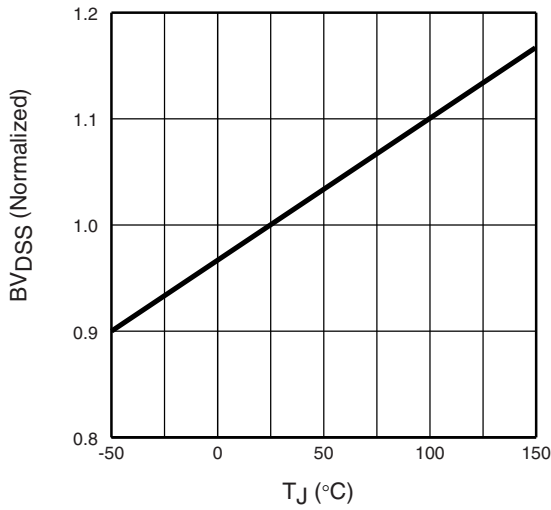

On Resistance vs. Drain Current

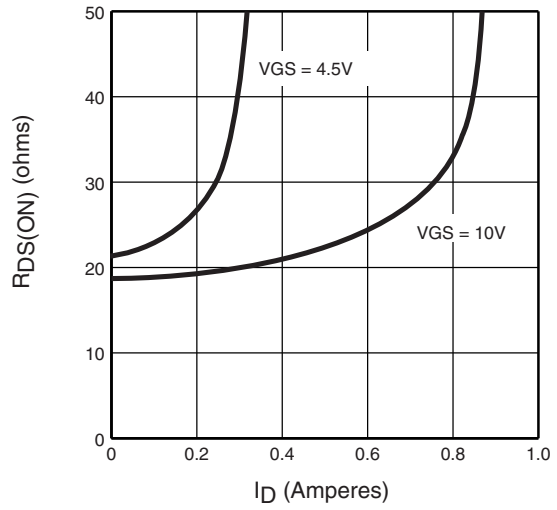

Transfer Characteristics

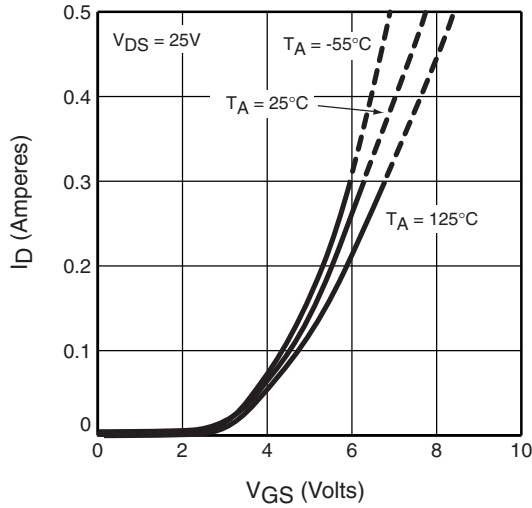

V_{GS(th)} and R_{DS(ON)} w/ Temperature

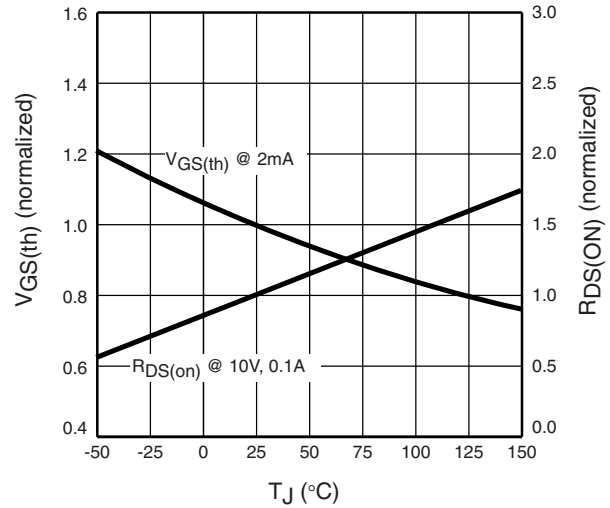

Capacitance vs. Drain Source Voltage

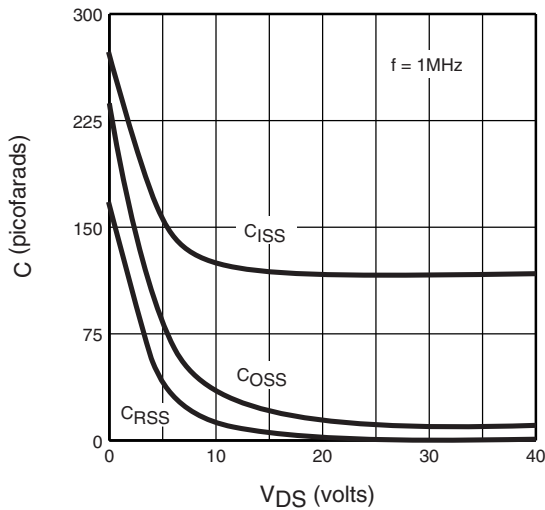

Gate Drive Dynamic Characteristics

