



SINGLE CHANNEL HIGH SIDE SOLID STATE RELAY

TYPE	$R_{DS(on)}$	I_{OUT}	V_{CC}
VN920SP	15m Ω	30 A	36 V

- CMOS COMPATIBLE INPUT
- PROPORTIONAL LOAD CURRENT SENSE
- SHORTED LOAD PROTECTION
- UNDERVOLTAGE AND OVERVOLTAGE SHUTDOWN
- OVERVOLTAGE CLAMP
- THERMAL SHUTDOWN
- CURRENT LIMITATION
- PROTECTION AGAINST LOSS OF GROUND AND LOSS V_{CC}
- VERY LOW STAND-BY POWER DISSIPATION
- REVERSE BATTERY PROTECTION (*)

DESCRIPTION

The VN920SP is a monolithic device designed in STMicroelectronics VIPower M0-3 Technology, intended for driving any kind of load with one side connected to ground. Active V_{CC} pin voltage clamp protects the device against low energy

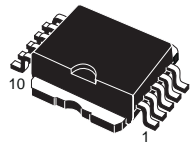

PowerSO-10™

ORDER CODES		
PACKAGE	TUBE	T&R
PowerSO-10™	VN920SP	VN920SP13TR

spikes (see ISO7637 transient compatibility table). Active current limitation combined with thermal shutdown and automatic restart protect the device against overload. The device integrates an analog current sense output which delivers a current proportional to the load current. Device automatically turns off in case of ground pin disconnection.

BLOCK DIAGRAM

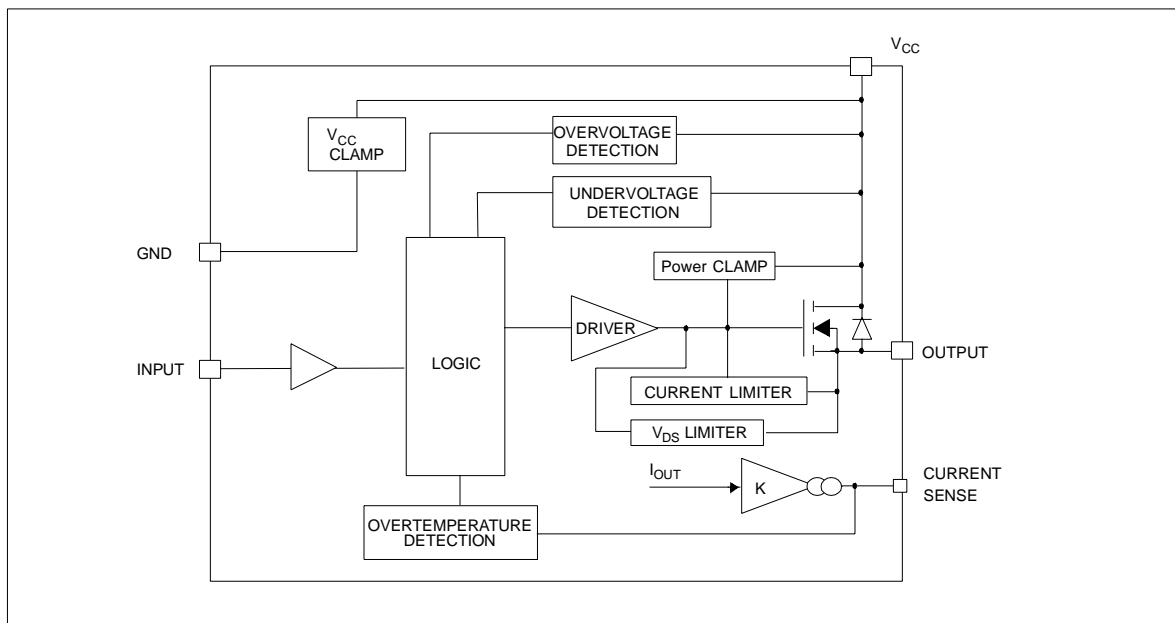

(*) See application schematic at page 8

VN920SP

ABSOLUTE MAXIMUM RATING

Symbol	Parameter	Value	Unit
V_{CC}	DC Supply Voltage	41	V
$-V_{CC}$	Reverse DC Supply Voltage	- 0.3	V
$-I_{GND}$	DC Reverse Ground Pin Current	- 200	mA
I_{OUT}	DC Output Current	Internally Limited	A
$-I_{OUT}$	Reverse DC Output Current	- 40	A
I_{IN}	DC Input Current	+/- 10	mA
V_{CSENSE}	Current Sense Maximum Voltage	-3	V
		+15	V
V_{ESD}	Electrostatic Discharge (Human Body Model: R=1.5K Ω ; C=100pF)		
	- INPUT	4000	V
	- CURRENT SENSE	2000	V
	- OUTPUT	5000	V
	- V_{CC}	5000	V
E_{MAX}	Maximum Switching Energy (L=0.25mH; $R_L=0\Omega$; $V_{bat}=13.5V$; $T_{jstart}=150^\circ C$; $I_L=45A$)	362	mJ
P_{tot}	Power Dissipation $T_C \leq 25^\circ C$	96.1	W
T_j	Junction Operating Temperature	Internally limited	$^\circ C$
T_C	Case Operating Temperature	- 40 to 150	$^\circ C$
T_{STG}	Storage Temperature	- 55 to 150	$^\circ C$

CONNECTION DIAGRAM (TOP VIEW)

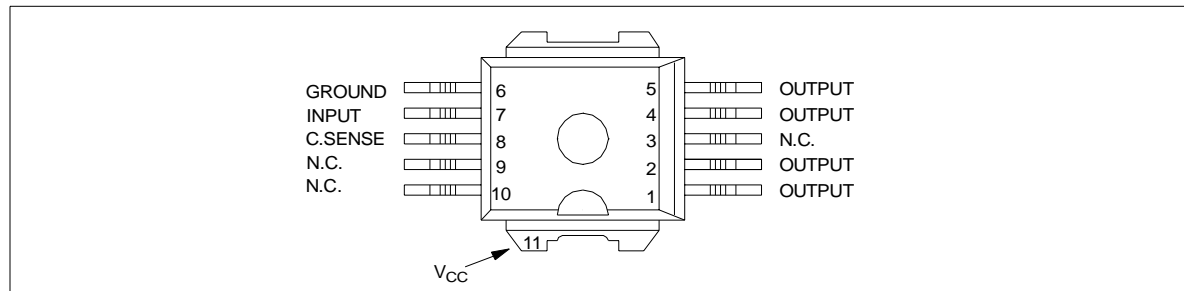

CURRENT AND VOLTAGE CONVENTIONS

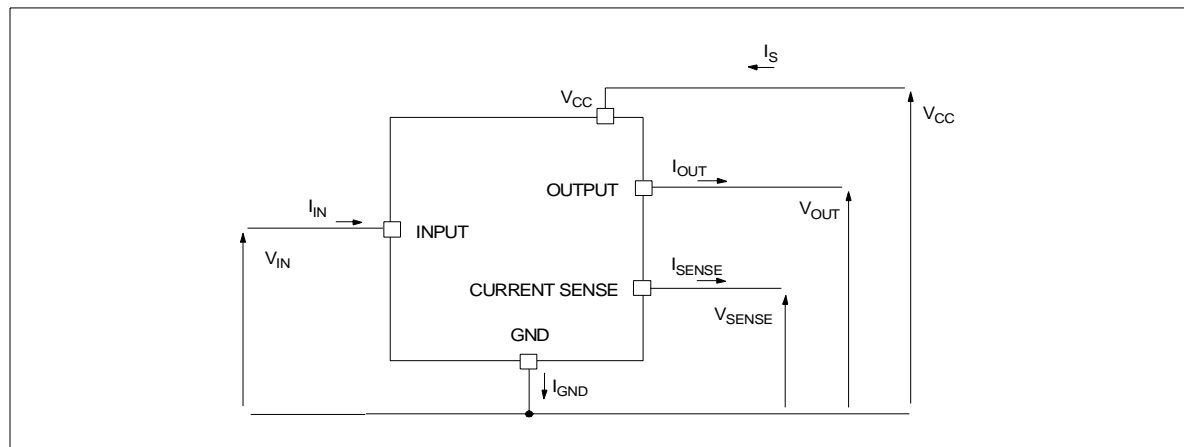

THERMAL DATA

Symbol	Parameter	Value	Unit	
$R_{thj-case}$	Thermal Resistance Junction-case	Max	1.3	$^{\circ}C/W$
$R_{thj-amb}$	Thermal Resistance Junction-ambient	Max	51.3 (*)	$^{\circ}C/W$

(*) When mounted on a standard single-sided FR-4 board with $0.5cm^2$ of Cu (at least $35\mu m$ thick).

ELECTRICAL CHARACTERISTICS ($8V < V_{CC} < 36V$; $-40^{\circ}C < T_j < 150^{\circ}C$ unless otherwise specified)

POWER

Symbol	Parameter	Test Conditions	Min	Typ	Max	Unit
V_{CC}	Operating Supply Voltage		5.5	13	36	V
V_{USD}	Undervoltage Shut-down		3	4	5.5	V
V_{OV}	Overvoltage Shut-down		36			V
R_{ON}	On State Resistance	$I_{OUT}=10A$; $T_j=25^{\circ}C$			15	$m\Omega$
		$I_{OUT}=10A$			30	$m\Omega$
		$I_{OUT}=3A$; $V_{CC}=6V$			50	$m\Omega$
V_{clamp}	Clamp Voltage	$I_{CC}=20mA$ (See note 1)	41	48	55	V
I_S	Supply Current	Off State; $V_{CC}=13V$; $V_{IN}=V_{OUT}=0V$		10	25	μA
		Off State; $V_{CC}=13V$; $T_j=25^{\circ}C$; $V_{IN}=V_{OUT}=0V$		10	20	μA
		On State; $V_{CC}=13V$; $V_{IN}=5V$; $I_{OUT}=0$; $R_{SENSE}=3.9K\Omega$			5	mA
$I_{L(off1)}$	Off State Output Current	$V_{IN}=V_{OUT}=0V$	0		50	μA
$I_{L(off2)}$	Off State Output Current	$V_{IN}=0V$; $V_{OUT}=3.5V$	-75		0	μA
$I_{L(off3)}$	Off State Output Current	$V_{IN}=V_{OUT}=0V$; $V_{CC}=13V$; $T_j=125^{\circ}C$			5	μA
$I_{L(off4)}$	Off State Output Current	$V_{IN}=V_{OUT}=0V$; $V_{CC}=13V$; $T_j=25^{\circ}C$			3	μA

SWITCHING ($V_{CC}=13V$)

Symbol	Parameter	Test Conditions	Min	Typ	Max	Unit
$t_{d(on)}$	Turn-on Delay Time	$R_L=1.3\Omega$ (see figure 2)		50		μs
$t_{d(off)}$	Turn-off Delay Time	$R_L=1.3\Omega$ (see figure 2)		50		μs
$dV_{OUT}/dt_{(on)}$	Turn-on Voltage Slope	$R_L=1.3\Omega$ (see figure 2)		See relative diagram		$V/\mu s$
$dV_{OUT}/dt_{(off)}$	Turn-off Voltage Slope	$R_L=1.3\Omega$ (see figure 2)		See relative diagram		$V/\mu s$

LOGIC INPUT

Symbol	Parameter	Test Conditions	Min	Typ	Max	Unit
V_{IL}	Input Low Level				1.25	V
I_{IL}	Low Level Input Current	$V_{IN}=1.25V$	1			μA
V_{IH}	Input High Level		3.25			V
I_{IH}	High Level Input Current	$V_{IN}=3.25V$			10	μA
$V_{I(hyst)}$	Input Hysteresis Voltage		0.5			V
V_{ICL}	Input Clamp Voltage	$I_{IN}=1mA$	6	6.8	8	V
		$I_{IN}=-1mA$		-0.7		V

Note 1: V_{clamp} and V_{OV} are correlated. Typical difference is 5V.

ELECTRICAL CHARACTERISTICS (continued)
CURRENT SENSE ($9V \leq V_{CC} \leq 16V$) (See Fig. 1)

Symbol	Parameter	Test Conditions	Min	Typ	Max	Unit
K_1	I_{OUT}/I_{SENSE}	$I_{OUT}=1A; V_{SENSE}=0.5V;$ $T_j = -40^\circ C \dots 150^\circ C$	3300	4400	6000	
dK_1/K_1	Current Sense Ratio Drift	$I_{OUT}=1A; V_{SENSE}=0.5V;$ $T_j = -40^\circ C \dots +150^\circ C$	-10		+10	%
K_2	I_{OUT}/I_{SENSE}	$I_{OUT}=10A; V_{SENSE}=4V; T_j=-40^\circ C$ $T_j=25^\circ C \dots 150^\circ C$	4200 4400	4900 4900	6000 5750	
dK_2/K_2	Current Sense Ratio Drift	$I_{OUT}=10A; V_{SENSE}=4V;$ $T_j=-40^\circ C \dots +150^\circ C$	-8		+8	%
K_3	I_{OUT}/I_{SENSE}	$I_{OUT}=30A; V_{SENSE}=4V; T_j=-40^\circ C$ $T_j=25^\circ C \dots 150^\circ C$	4200 4400	4900 4900	5500 5250	
dK_3/K_3	Current Sense Ratio Drift	$I_{OUT}=30A; V_{SENSE}=4V;$ $T_j=-40^\circ C \dots +150^\circ C$	-6		+6	%
I_{SENSE0}	Analog Sense Leakage Current	$V_{CC}=6 \dots 16V; I_{OUT}=0A; V_{SENSE}=0V;$ $T_j=-40^\circ C \dots +150^\circ C$	0		10	μA
V_{SENSE}	Max Analog Sense Output Voltage	$V_{CC}=5.5V; I_{OUT}=5A; R_{SENSE}=10K\Omega$ $V_{CC}>8V; I_{OUT}=10A; R_{SENSE}=10K\Omega$	2 4			V V
V_{SENSEH}	Sense Voltage in Overtemperature conditions	$V_{CC}=13V; R_{SENSE}=3.9K\Omega$		5.5		V
$R_{VSENSEH}$	Analog sense output impedance in overtemperature condition	$V_{CC}=13V; T_j > T_{TSD};$ Output Open		400		Ω
t_{DSENSE}	Current sense delay response	to 90% I_{SENSE} (see note 2)			500	μs

PROTECTIONS

Symbol	Parameter	Test Conditions	Min	Typ	Max	Unit
T_{TSD}	Shut-down Temperature		150	175	200	$^\circ C$
T_R	Reset Temperature		135			$^\circ C$
T_{hyst}	Thermal Hysteresis		7	15		$^\circ C$
I_{lim}	DC Short Circuit Current	$V_{CC}=13V$ $5V < V_{CC} < 36V$	30	45	75 75	A A
V_{demag}	Turn-off Output Clamp Voltage	$I_{OUT}=2A; V_{IN}=0V; L=6mH$	$V_{CC}-41$	$V_{CC}-48$	$V_{CC}-55$	V
V_{ON}	Output Voltage Drop Limitation	$I_{OUT}=1A; T_j=-40^\circ C \dots +150^\circ C$		50		mV

Note 2: current sense signal delay after positive input slope
 Note: Sense pin doesn't have to be left floating.

Figure 1: I_{OUT}/I_{SENSE} versus I_{OUT}

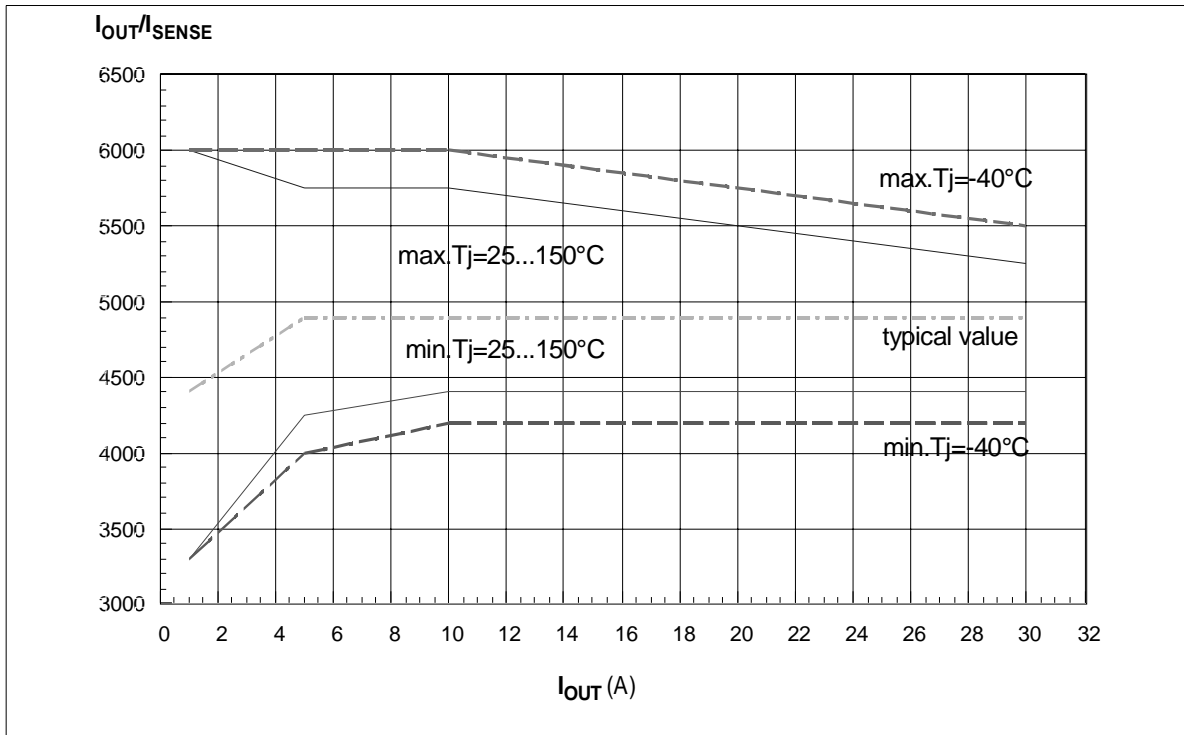
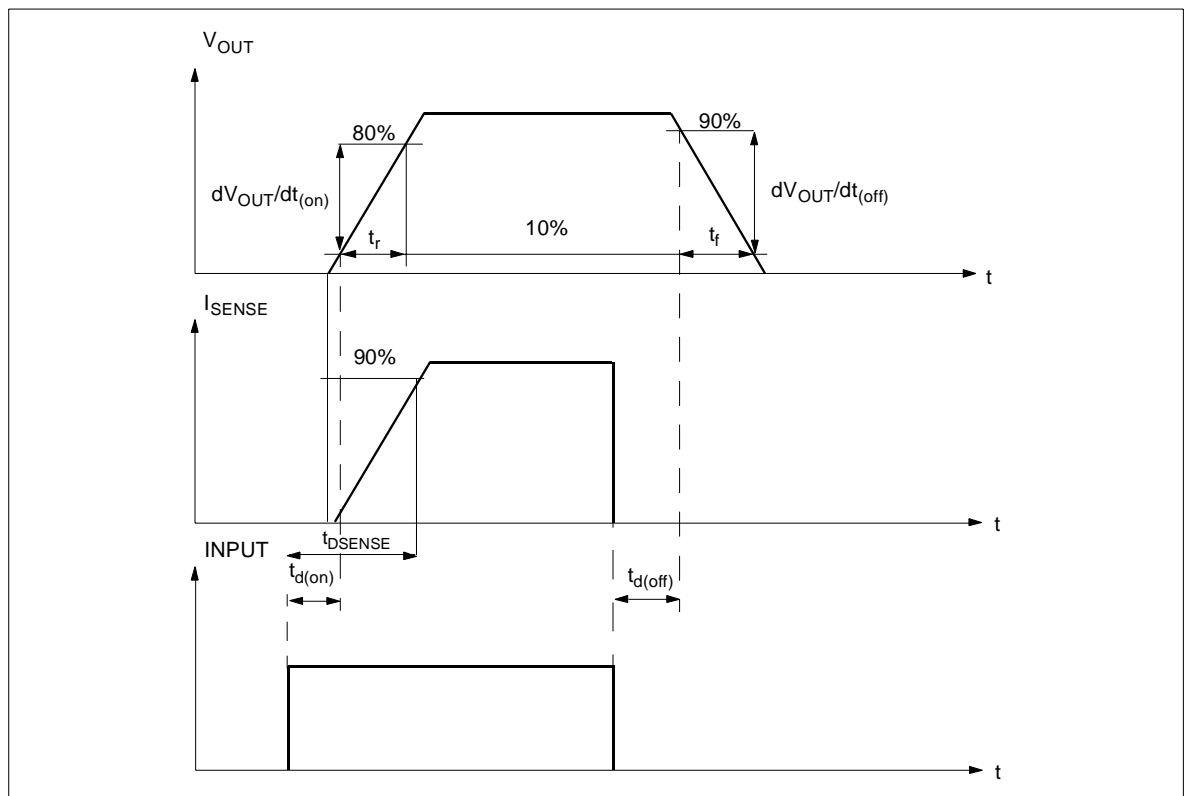

Figure 2: Switching Characteristics (Resistive load $R_L = 1.3\Omega$)



VN920SP

TRUTH TABLE

CONDITIONS	INPUT	OUTPUT	SENSE
Normal operation	L	L	0
	H	H	Nominal
Overtemperature	L	L	0
	H	L	V_{SENSEH}
Undervoltage	L	L	0
	H	L	0
Overvoltage	L	L	0
	H	L	0
Short circuit to GND	L	L	0
	H	L	$(T_j < T_{TSD})$ 0
	H	L	$(T_j > T_{TSD})$ V_{SENSEH}
Short circuit to V_{CC}	L	H	0
	H	H	< Nominal
Negative output voltage clamp	L	L	0

ELECTRICAL TRANSIENT REQUIREMENTS

ISO T/R 7637/1 Test Pulse	TEST LEVELS				Delays and Impedance
	I	II	III	IV	
1	-25 V	-50 V	-75 V	-100 V	2 ms 10 Ω
2	+25 V	+50 V	+75 V	+100 V	0.2 ms 10 Ω
3a	-25 V	-50 V	-100 V	-150 V	0.1 μ s 50 Ω
3b	+25 V	+50 V	+75 V	+100 V	0.1 μ s 50 Ω
4	-4 V	-5 V	-6 V	-7 V	100 ms, 0.01 Ω
5	+26.5 V	+46.5 V	+66.5 V	+86.5 V	400 ms, 2 Ω

ISO T/R 7637/1 Test Pulse	TEST LEVELS RESULTS			
	I	II	III	IV
1	C	C	C	C
2	C	C	C	C
3a	C	C	C	C
3b	C	C	C	C
4	C	C	C	C
5	C	E	E	E

CLASS	CONTENTS
C	All functions of the device are performed as designed after exposure to disturbance.
E	One or more functions of the device is not performed as designed after exposure to disturbance and cannot be returned to proper operation without replacing the device.

Figure 3: Waveforms

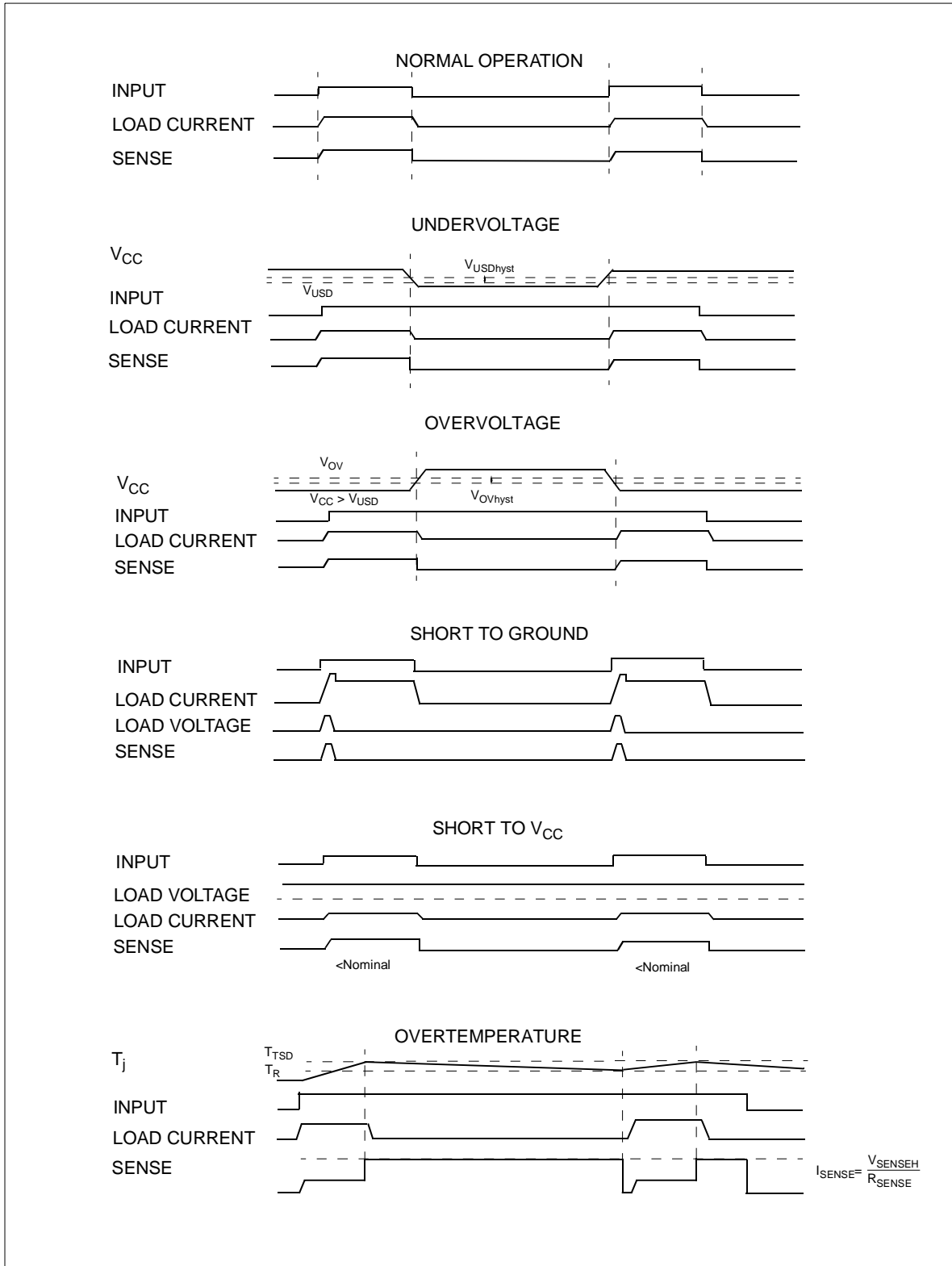

APPLICATION SCHEMATIC

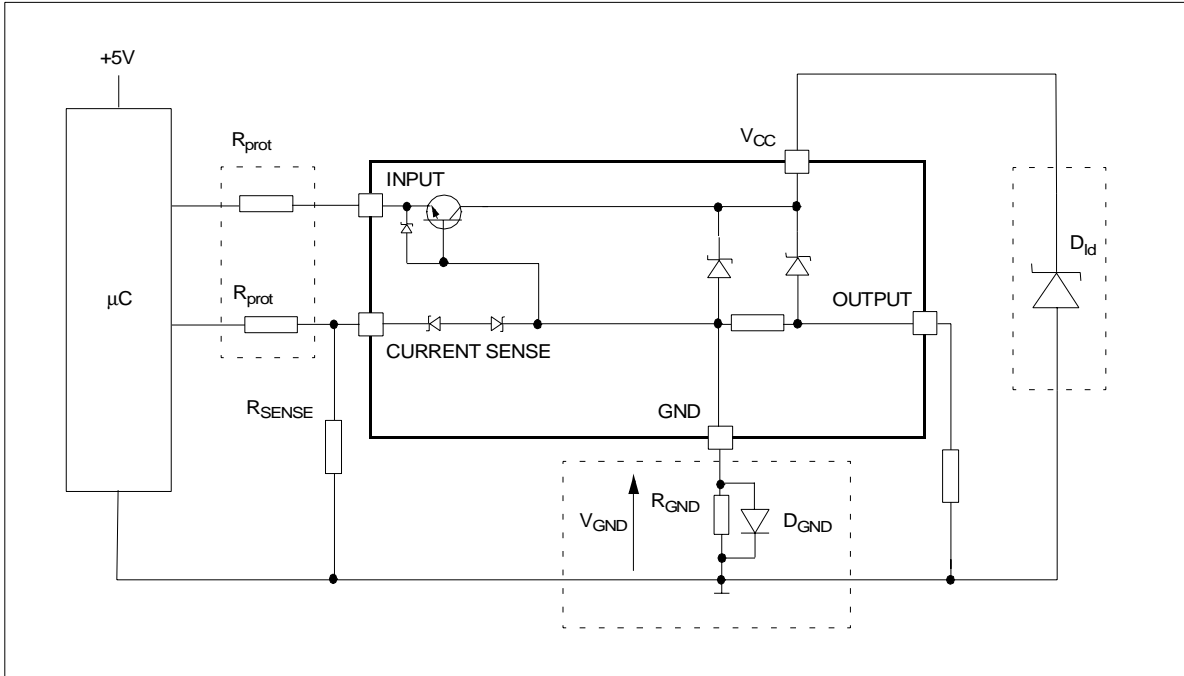

GND PROTECTION NETWORK AGAINST REVERSE BATTERY

Solution 1: Resistor in the ground line (R_{GND} only). This can be used with any type of load.

The following is an indication on how to dimension the R_{GND} resistor.

- 1) $R_{GND} \leq 600mV / (I_{S(on)max})$.
- 2) $R_{GND} \geq (-V_{CC}) / (-I_{GND})$

where $-I_{GND}$ is the DC reverse ground pin current and can be found in the absolute maximum rating section of the device's datasheet.

Power Dissipation in R_{GND} (when $V_{CC} < 0$: during reverse battery situations) is:

$$P_D = (-V_{CC})^2 / R_{GND}$$

This resistor can be shared amongst several different HSD. Please note that the value of this resistor should be calculated with formula (1) where $I_{S(on)max}$ becomes the sum of the maximum on-state currents of the different devices.

Please note that if the microprocessor ground is not common with the DC reverse ground then the R_{GND} will produce a shift ($I_{S(on)max} * R_{GND}$) in the input thresholds and the status output values. This shift will vary depending on how many devices are ON in the case of several high side drivers sharing the same R_{GND} .

If the calculated power dissipation leads to a large resistor or several devices have to share the same resistor then the ST suggests to utilize Solution 2 (see below).

Solution 2: A diode (D_{GND}) in the ground line.

A resistor ($R_{GND} = 1k\Omega$) should be inserted in parallel to D_{GND} if the device will be driving an inductive load.

This small signal diode can be safely shared amongst several different HSD. Also in this case, the presence of the ground network will produce a shift ($\approx 600mV$) in the input threshold and the status output values if the microprocessor ground is not common with the device ground. This shift will not vary if more than one HSD shares the same diode/resistor network.

LOAD DUMP PROTECTION

D_{id} is necessary (Voltage Transient Suppressor) if the load dump peak voltage exceeds V_{CC} max DC rating. The same applies if the device will be subject to transients on the V_{CC} line that are greater than the ones shown in the ISO T/R 7637/1 table.

µC I/Os PROTECTION:

If a ground protection network is used and negative transients are present on the V_{CC} line, the control pins will be pulled negative. ST suggests to insert a resistor (R_{prot}) in line to prevent the μC I/Os pins to latch-up.

The value of these resistors is a compromise between the leakage current of μC and the current required by the HSD I/Os (Input levels compatibility) with the latch-up limit of μC I/Os.

$$-V_{CCpeak} / I_{latchup} \leq R_{prot} \leq (V_{OH\mu C} - V_{IH} - V_{GND}) / I_{IHmax}$$

Calculation example:

For $V_{CCpeak} = -100V$ and $I_{latchup} \geq 20mA$; $V_{OH\mu C} \geq 4.5V$

$$5k\Omega \leq R_{prot} \leq 65k\Omega$$

Recommended R_{prot} value is 10k Ω .

Off State Output Current

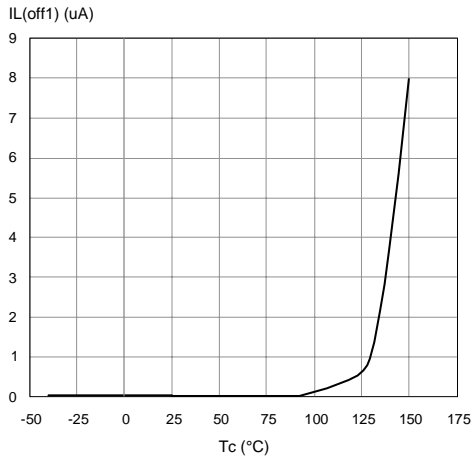

High Level Input Current

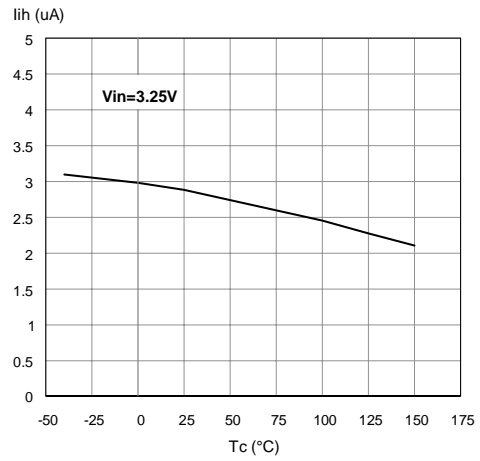

Input Clamp Voltage

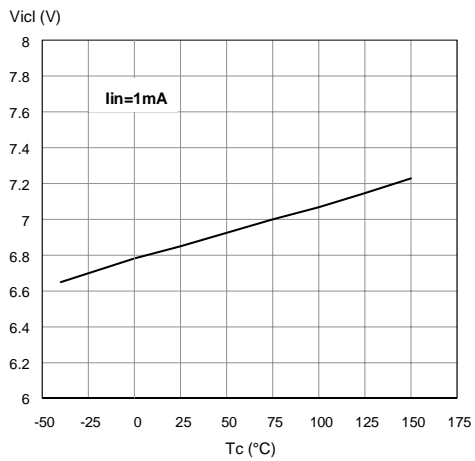

Input High Level

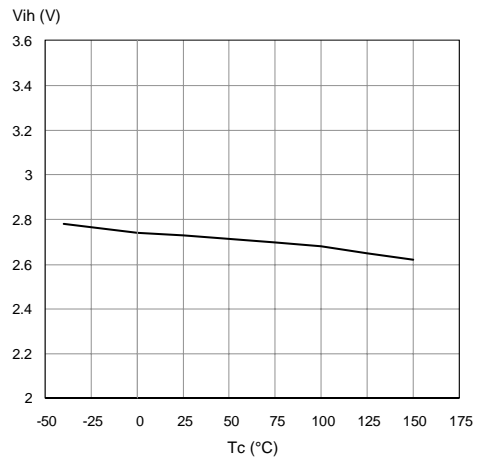

Input Low Level

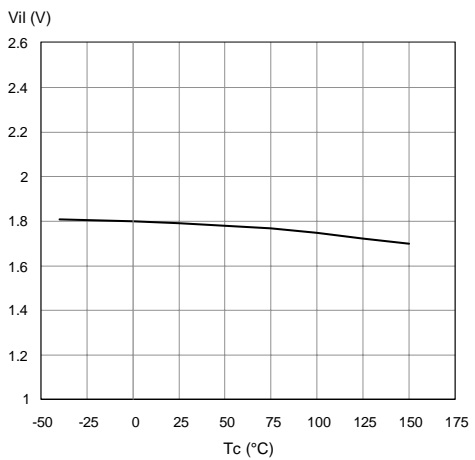

Input Hysteresis Voltage

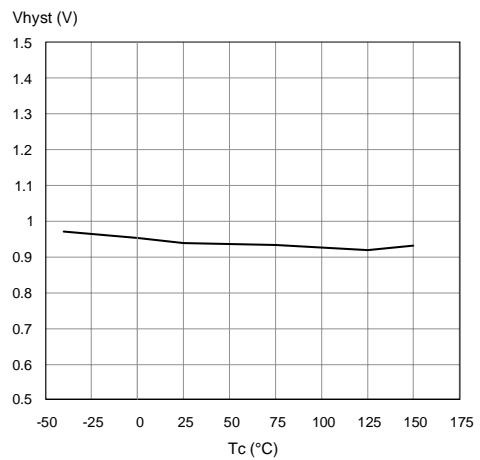

Overvoltage Shutdown

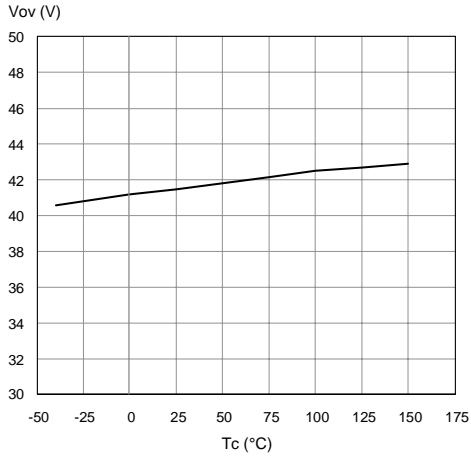

I_{LIM} Vs T_{case}

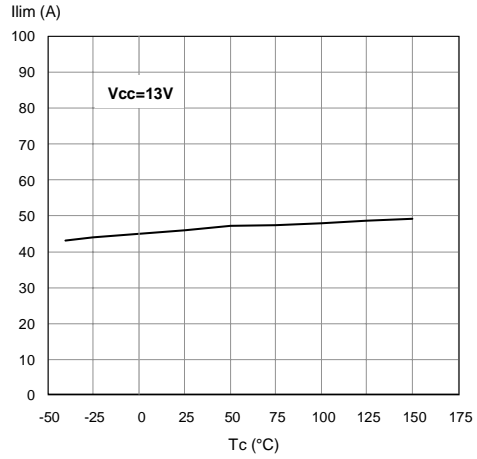

Turn-on Voltage Slope

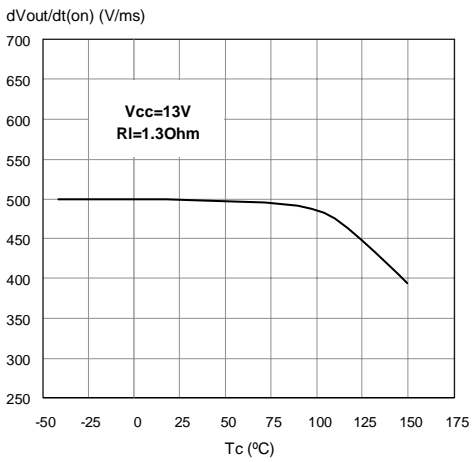

Turn-off Voltage Slope

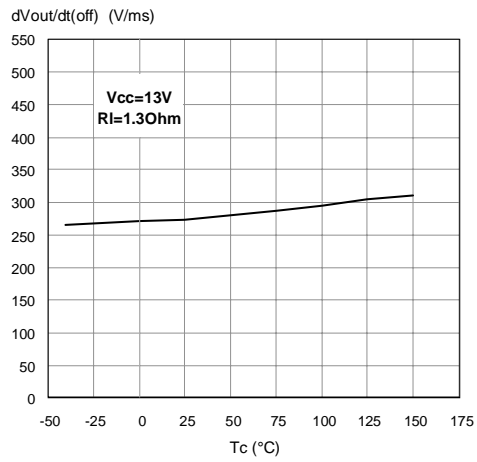

On State Resistance Vs T_{case}

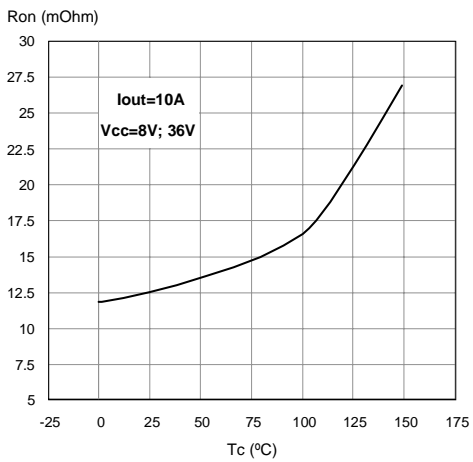

On State Resistance Vs V_{CC}

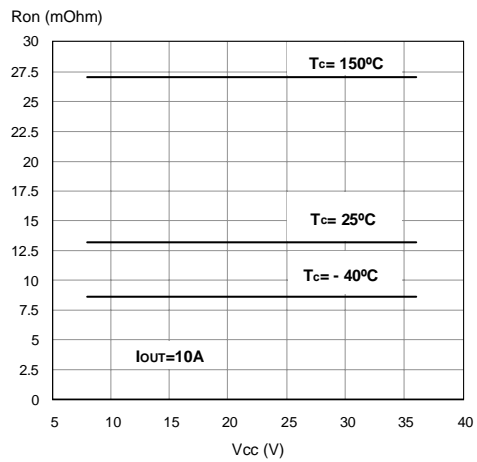

Maximum turn off current versus load inductance

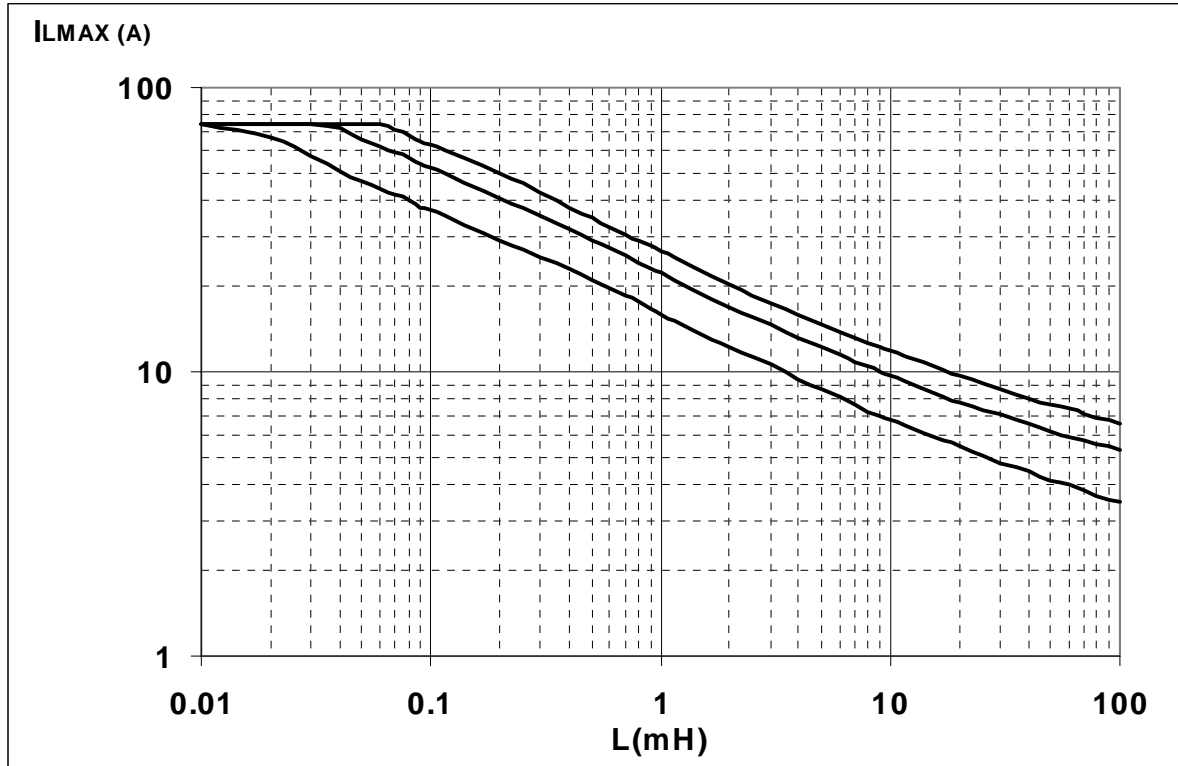

- A = Single Pulse at $T_{Jstart}=150^{\circ}C$
- B= Repetitive pulse at $T_{Jstart}=100^{\circ}C$
- C= Repetitive Pulse at $T_{Jstart}=125^{\circ}C$

Conditions:

$V_{CC}=13.5V$

Values are generated with $R_L=0\Omega$

In case of repetitive pulses, T_{Jstart} (at beginning of each demagnetization) of every pulse must not exceed the temperature specified above for curves B and C.

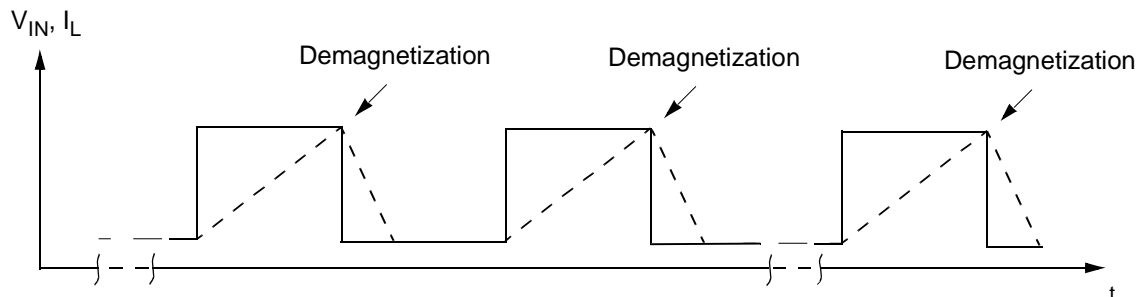

PowerSO-10™ THERMAL DATA

PowerSO-10™ PC Board

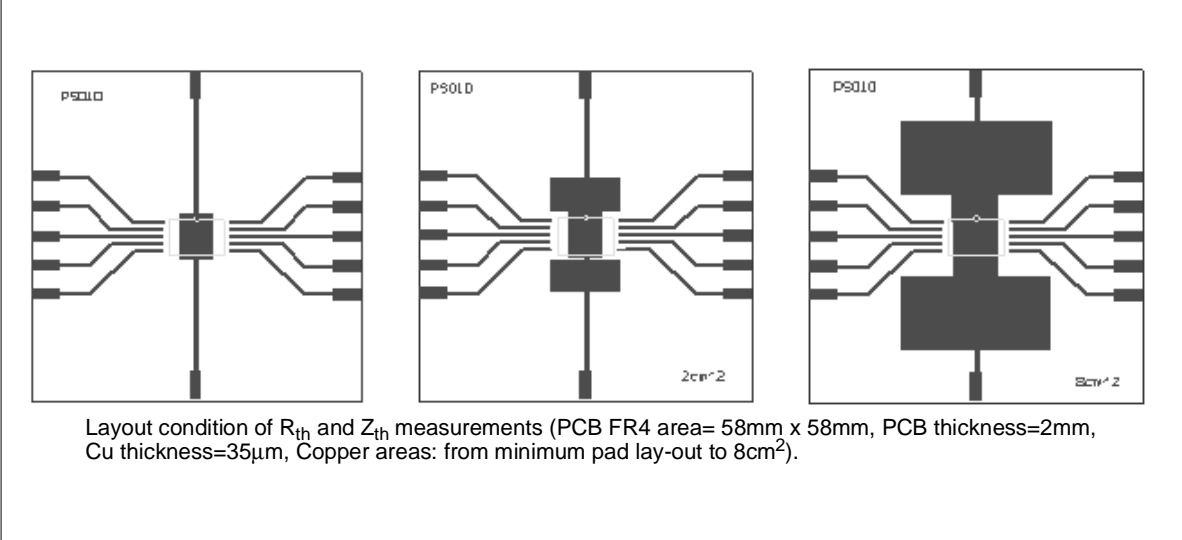

$R_{thj-amb}$ Vs PCB copper area in open box free air condition

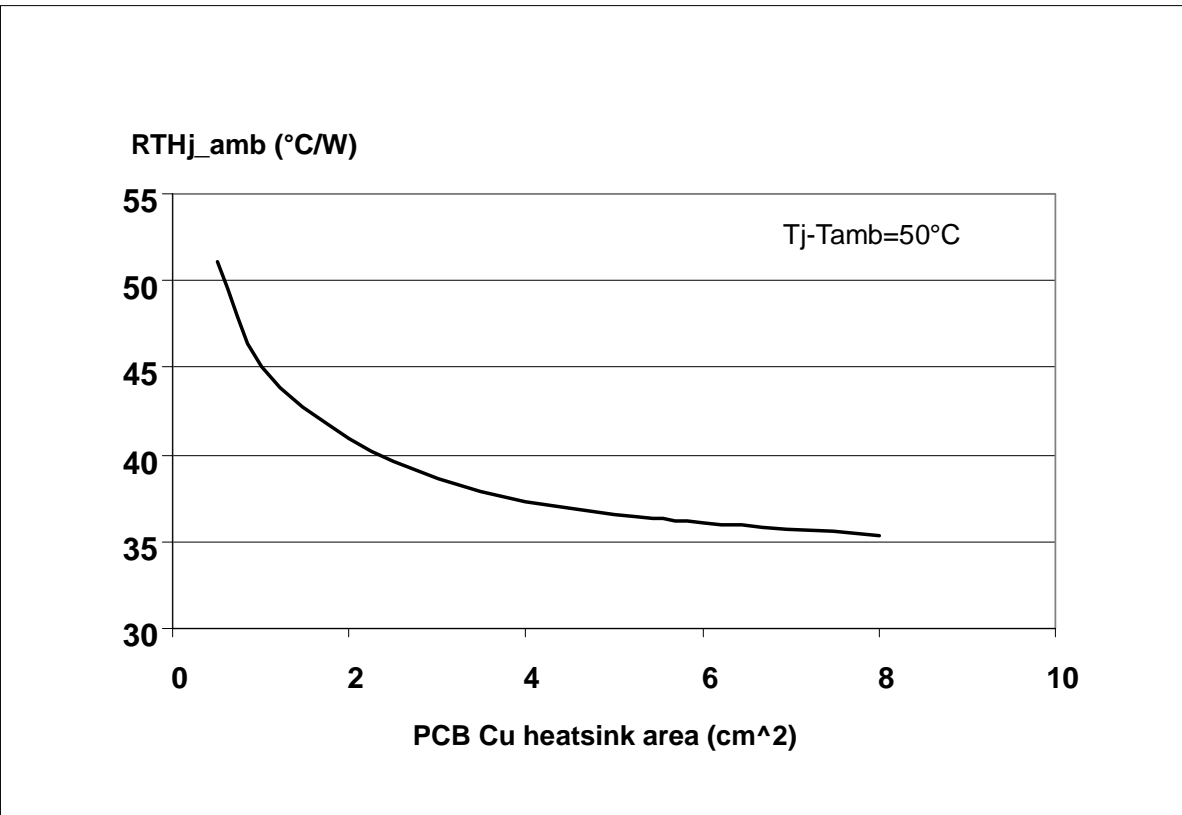

PowerSO-10 Thermal Impedance Junction Ambient Single Pulse

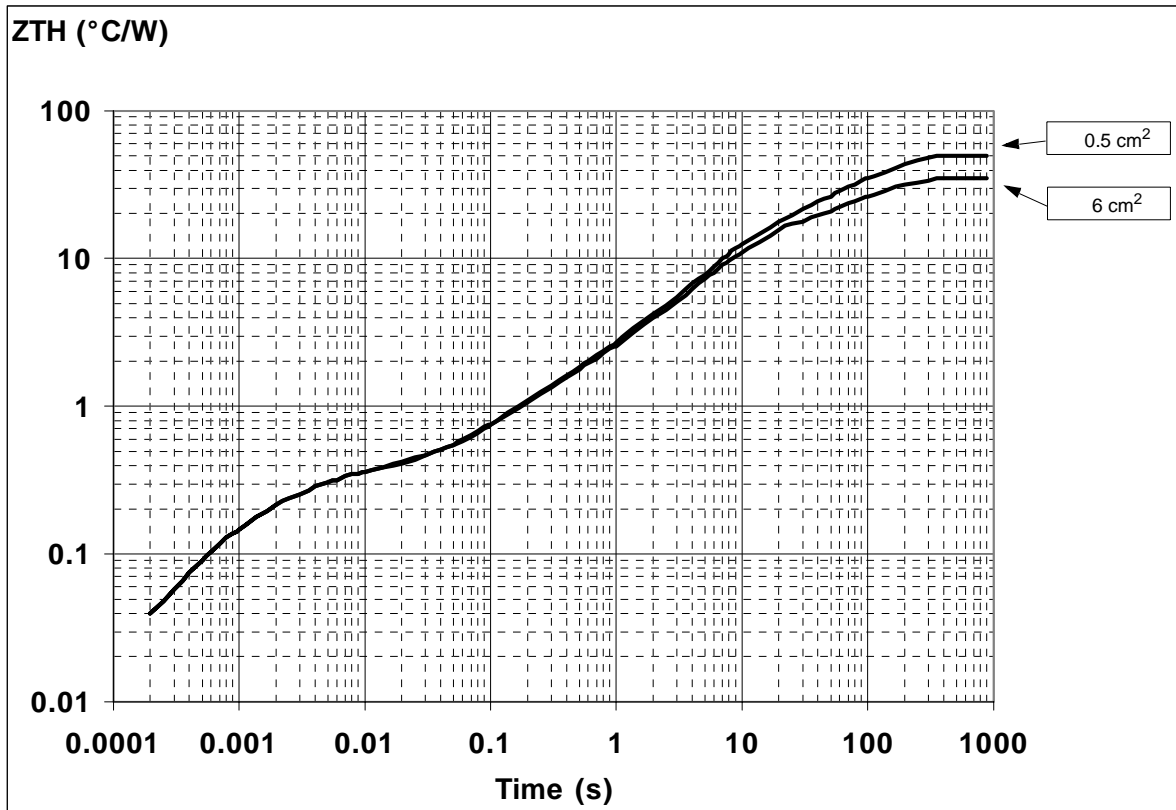

Thermal fitting model of a single channel HSD in PowerSO-10

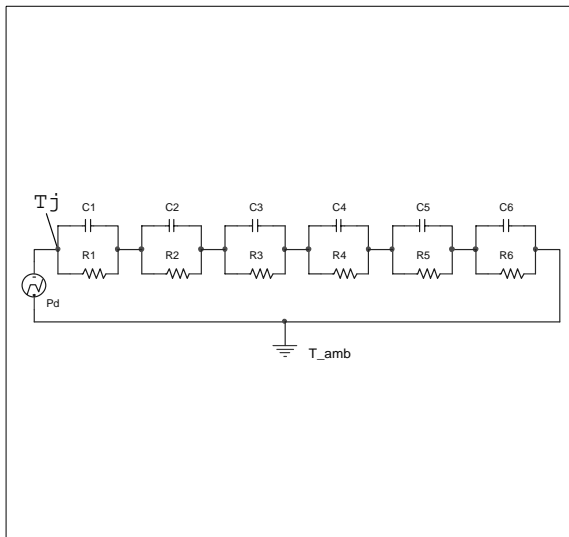

Pulse calculation formula

$$Z_{TH\delta} = R_{TH} \cdot \delta + Z_{THtp}(1 - \delta)$$

where $\delta = t_p/T$

Thermal Parameter

Area/island (cm ²)	0.5	6
R1 (°C/W)	0.02	
R2 (°C/W)	0.1	
R3 (°C/W)	0.2	
R4 (°C/W)	0.8	
R5 (°C/W)	12	
R6 (°C/W)	37	22
C1 (W.s/°C)	0.0015	
C2 (W.s/°C)	7.00E-03	
C3 (W.s/°C)	0.015	
C4 (W.s/°C)	0.3	
C5 (W.s/°C)	0.75	
C6 (W.s/°C)	3	5

PowerSO-10™ MECHANICAL DATA

DIM.	mm.			inch		
	MIN.	TYP.	MAX.	MIN.	TYP.	MAX.
A	3.35		3.65	0.132		0.144
A (*)	3.4		3.6	0.134		0.142
A1	0.00		0.10	0.000		0.004
B	0.40		0.60	0.016		0.024
B (*)	0.37		0.53	0.014		0.021
C	0.35		0.55	0.013		0.022
C (*)	0.23		0.32	0.009		0.0126
D	9.40		9.60	0.370		0.378
D1	7.40		7.60	0.291		0.300
E	9.30		9.50	0.366		0.374
E2	7.20		7.60	0.283		300
E2 (*)	7.30		7.50	0.287		0.295
E4	5.90		6.10	0.232		0.240
E4 (*)	5.90		6.30	0.232		0.248
e		1.27			0.050	
F	1.25		1.35	0.049		0.053
F (*)	1.20		1.40	0.047		0.055
H	13.80		14.40	0.543		0.567
H (*)	13.85		14.35	0.545		0.565
h		0.50			0.002	
L	1.20		1.80	0.047		0.070
L (*)	0.80		1.10	0.031		0.043
α	0°		8°	0°		8°
α (*)	2°		8°	2°		8°

(*) Muar only POA P013P

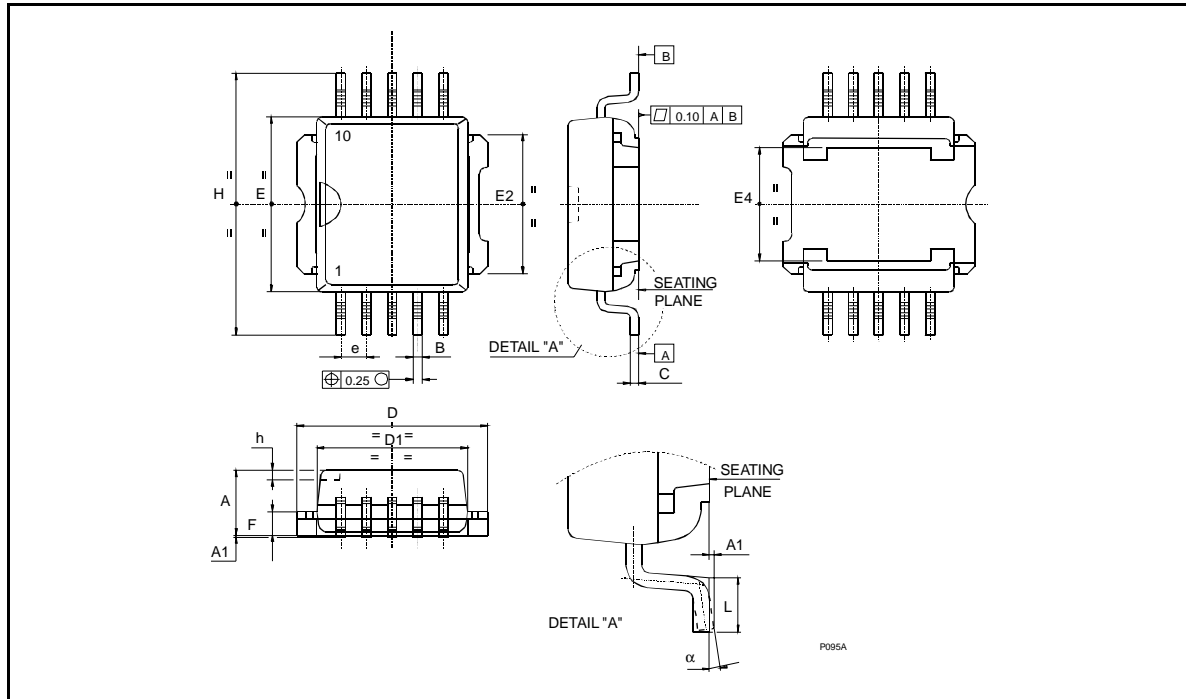

PowerSO-10™ SUGGESTED PAD LAYOUT

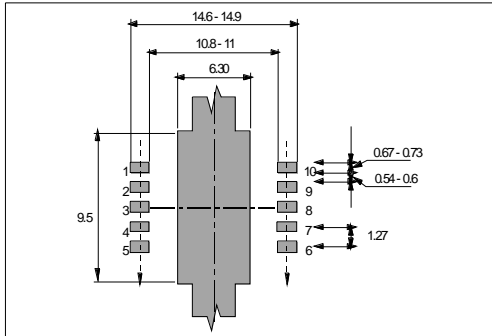

TUBE SHIPMENT (no suffix)

All dimensions are in mm.

	Base Q.ty	Bulk Q.ty	Tube length (±0.5)	A	B	C (±0.1)
Casablanca	50	1000	532	10.4	16.4	0.8
Muar	50	1000	532	4.9	17.2	0.8

TAPE AND REEL SHIPMENT (suffix "13TR")

40mm min. Access hole at slot location

Full radius

Tape slot in core for tape start 2.5mm min. width.

G measured at hub

REEL DIMENSIONS

Base Q.ty	600
Bulk Q.ty	600
A (max)	330
B (min)	1.5
C (± 0.2)	13
F	20.2
G (+ 2 / -0)	24.4
N (min)	60
T (max)	30.4

All dimensions are in mm.

TAPE DIMENSIONS
According to Electronic Industries Association (EIA) Standard 481 rev. A, Feb 1986

Tape width	W	24
Tape Hole Spacing	P0 (± 0.1)	4
Component Spacing	P	24
Hole Diameter	D (± 0.1/-0)	1.5
Hole Diameter	D1 (min)	1.5
Hole Position	F (± 0.05)	11.5
Compartment Depth	K (max)	6.5
Hole Spacing	P1 (± 0.1)	2

TOP COVER TAPE

User Direction of Feed

End

Start

No components

Components

No components

500mm min

Empty components pockets sealed with cover tape.

User direction of feed

Information furnished is believed to be accurate and reliable. However, STMicroelectronics assumes no responsibility for the consequences of use of such information nor for any infringement of patents or other rights of third parties which may result from its use. No license is granted by implication or otherwise under any patent or patent rights of STMicroelectronics. Specifications mentioned in this publication are subject to change without notice. This publication supersedes and replaces all information previously supplied. STMicroelectronics products are not authorized for use as critical components in life support devices or systems without express written approval of STMicroelectronics.
The ST logo is a trademark of STMicroelectronics

© 2002 STMicroelectronics - Printed in ITALY- All Rights Reserved.

STMicroelectronics GROUP OF COMPANIES

Australia - Brazil - Canada - China - Finland - France - Germany - Hong Kong - India - Israel - Italy - Japan - Malaysia -
Malta - Morocco - Singapore - Spain - Sweden - Switzerland - United Kingdom - U.S.A.

<http://www.st.com>