



## P-Channel Enhancement-Mode Vertical DMOS FET

### Features

- ▶ Free from secondary breakdown
- ▶ Low power drive requirement
- ▶ Ease of paralleling
- ▶ Low  $C_{ISS}$  and fast switching speeds
- ▶ High input impedance and high gain
- ▶ Excellent thermal stability
- ▶ Integral source-to-drain diode

### Applications

- ▶ Motor controls
- ▶ Converters
- ▶ Amplifiers
- ▶ Switches
- ▶ Power supply circuits
- ▶ Drivers (relays, hammers, solenoids, lamps, memories, displays, bipolar transistors, etc.)

### General Description

The Supertex VP2450 is an enhancement-mode (normally-off) transistor that utilizes a vertical DMOS structure and Supertex's well-proven silicon-gate manufacturing process. This combination produces a device with the power handling capabilities of bipolar transistors, and the high input impedance and positive temperature coefficient inherent in MOS devices. Characteristic of all MOS structures, this device is free from thermal runaway and thermally-induced secondary breakdown.

Supertex's vertical DMOS FETs are ideally suited to a wide range of switching and amplifying applications where very low threshold voltage, high breakdown voltage, high input impedance, low input capacitance, and fast switching speeds are desired.

### Ordering Information

Device	Package Options		$BV_{DSS}/BV_{DGS}$ (V)	$R_{DS(ON)}$ (max) ( $\Omega$ )	$I_{D(ON)}$ (min) (mA)
	TO-92	TO-243AA (SOT-89)			
VP2450	VP2450N3-G	VP2450N8-G	-500	30	-200

-G indicates package is RoHS compliant ("Green")



### Absolute Maximum Ratings

Parameter	Value
Drain-to-Source voltage	$BV_{DSS}$
Drain-to-Gate voltage	$BV_{DGS}$
Gate-to-Source voltage	$\pm 20V$
Operating and storage temperature	$-55^{\circ}C$ to $+150^{\circ}C$
Soldering temperature*	$300^{\circ}C$

Absolute Maximum Ratings are those values beyond which damage to the device may occur. Functional operation under these conditions is not implied. Continuous operation of the device at the absolute rating level may affect device reliability. All voltages are referenced to device ground.

\* Distance of 1.6mm from case for 10 seconds.

### Pin Configurations

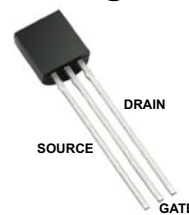

TO-92 (N3)

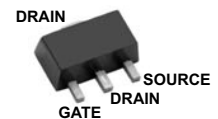

TO-243AA (SOT-89) (N8)

### Product Marking

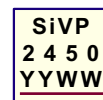

YY = Year Sealed  
WW = Week Sealed  
\_\_\_\_\_ = "Green" Packaging

Package may or may not include the following marks: Si or

#### TO-92 (N3)

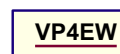

W = Code for week sealed  
\_\_\_\_\_ = "Green" Packaging

Packages may or may not include the following marks: Si or

#### TO-243AA (SOT-89) (N8)

### Thermal Characteristics

Package	$I_D$ (continuous) <sup>†</sup> (mA)	$I_D$ (pulsed) (mA)	Power Dissipation @ $T_c = 25^\circ\text{C}$ (W)	$\theta_{jc}$ ( $^\circ\text{C}/\text{W}$ )	$\theta_{ja}$ ( $^\circ\text{C}/\text{W}$ )	$I_{DR}$ <sup>†</sup> (mA)	$I_{DRM}$ (mA)
TO-92	-100	-300	1.0	125	170	-100	-300
TO-243AA (SOT-89)	-160	-800	1.6 <sup>‡</sup>	15	78	-160	-800

<sup>†</sup>  $I_D$  (continuous) is limited by max rated  $T_j$   
<sup>‡</sup> Mounted on FR5 board, 25mm x 25mm x 1.57mm.

### Electrical Characteristics ( $T_A = 25^\circ\text{C}$ unless otherwise specified)

Sym	Parameter	Min	Typ	Max	Units	Conditions
$BV_{DSS}$	Drain-to-source breakdown voltage	-500	-	-	V	$V_{GS} = 0\text{V}, I_D = -250\mu\text{A}$
$V_{GS(th)}$	Gate threshold voltage	-1.5	-	-3.5	V	$V_{GS} = V_{DS}, I_D = -1.0\text{mA}$
$\Delta V_{GS(th)}$	Change in $V_{GS(th)}$ with temperature	-	-	-4.8	mV/ $^\circ\text{C}$	$V_{GS} = V_{DS}, I_D = -1.0\text{mA}$
$I_{GSS}$	Gate body leakage	-	-	-100	nA	$V_{GS} = \pm 20\text{V}, V_{DS} = 0\text{V}$
$I_{DSS}$	Zero gate voltage drain current	-	-	-10	$\mu\text{A}$	$V_{GS} = 0\text{V}, V_{DS} = \text{Max Rating}$
		-	-	-1.0	mA	$V_{DS} = 0.8 \text{ Max Rating}, V_{GS} = 0\text{V}, T_A = 125^\circ\text{C}$
$I_{D(ON)}$	On-state drain current	-75	-	-	mA	$V_{GS} = -4.5\text{V}, V_{DS} = -15\text{V}$
		-200	-	-		$V_{GS} = -10\text{V}, V_{DS} = -15\text{V}$
$R_{DS(ON)}$	Static drain-to-source on-state resistance	-	-	35	$\Omega$	$V_{GS} = -4.5\text{V}, I_D = -50\text{mA}$
		-	-	30		$V_{GS} = -10\text{V}, I_D = -100\text{mA}$
$\Delta R_{DS(ON)}$	Change in $R_{DS(ON)}$ with temperature	-	-	0.75	%/ $^\circ\text{C}$	$V_{GS} = -10\text{V}, I_D = -100\text{mA}$
$G_{FS}$	Forward transconductance	150	320	-	mmho	$V_{DS} = -15\text{V}, I_D = -100\text{mA}$
$C_{ISS}$	Input capacitance	-	-	190	pF	$V_{GS} = 0\text{V}, V_{DS} = -25\text{V}, f = 1.0\text{MHz}$
$C_{OSS}$	Common source output capacitance	-	-	75		
$C_{RSS}$	Reverse transfer capacitance	-	-	20		
$t_{d(ON)}$	Turn-on delay time	-	-	10	ns	$V_{DD} = -25\text{V}, I_D = -200\text{mA}, R_{GEN} = 25\Omega$
$t_r$	Rise time	-	-	25		
$t_{d(OFF)}$	Turn-off delay time	-	-	45		
$t_f$	Fall time	-	-	25		
$V_{SD}$	Diode forward voltage drop	-	-	-1.8	V	$V_{GS} = 0\text{V}, I_{SD} = -100\text{mA}$
$t_{rr}$	Reverse recovery time	-	300	-	ns	$V_{GS} = 0\text{V}, I_{SD} = -100\text{mA}$

**Notes:**

1. All D.C. parameters 100% tested at  $25^\circ\text{C}$  unless otherwise stated. (Pulse test: 300 $\mu\text{s}$  pulse, 2% duty cycle.)
2. All A.C. parameters sample tested.

### Switching Waveforms and Test Circuit

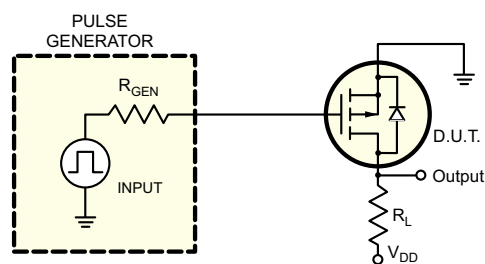
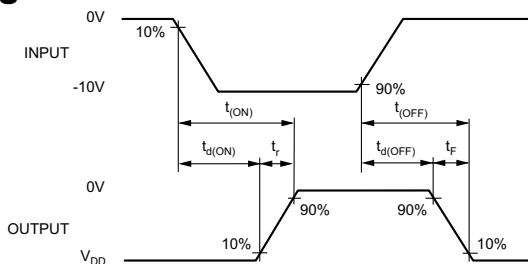

# Typical Performance Curves

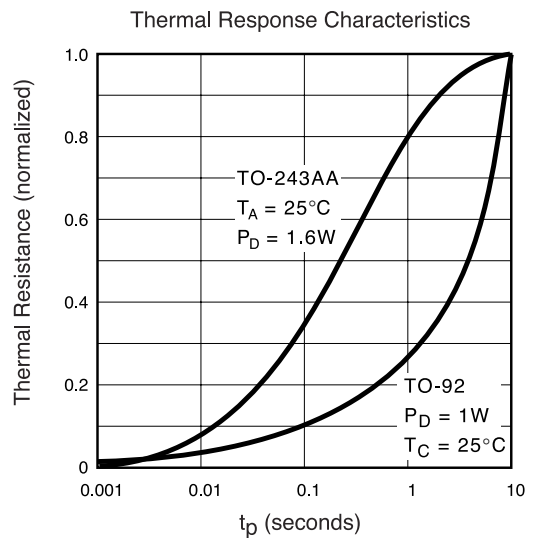
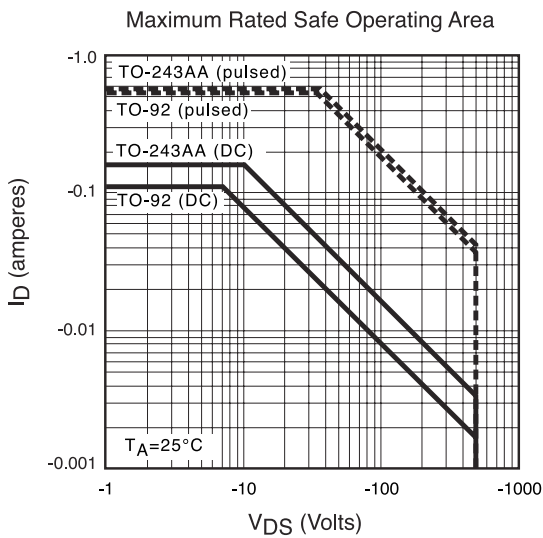
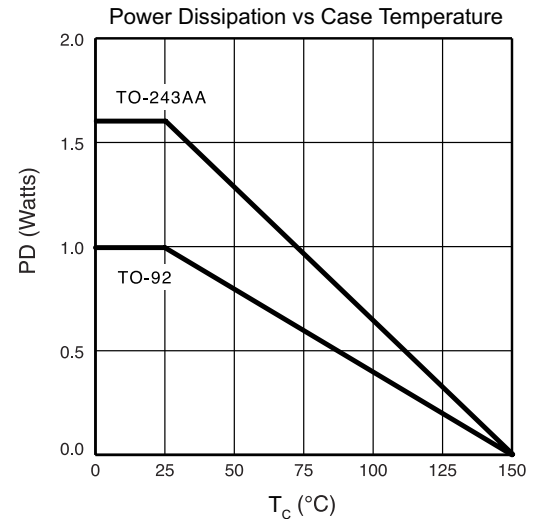
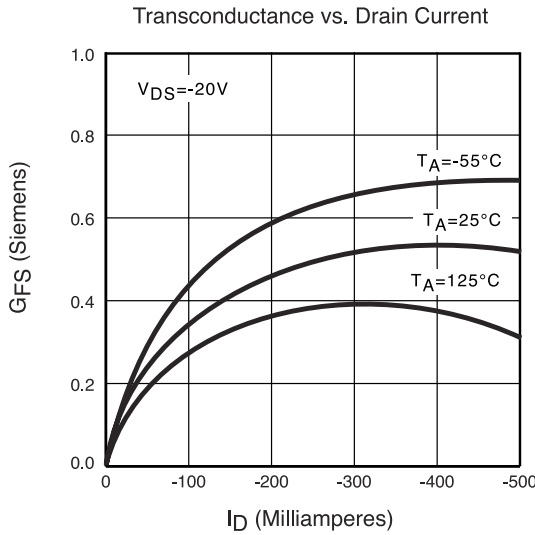
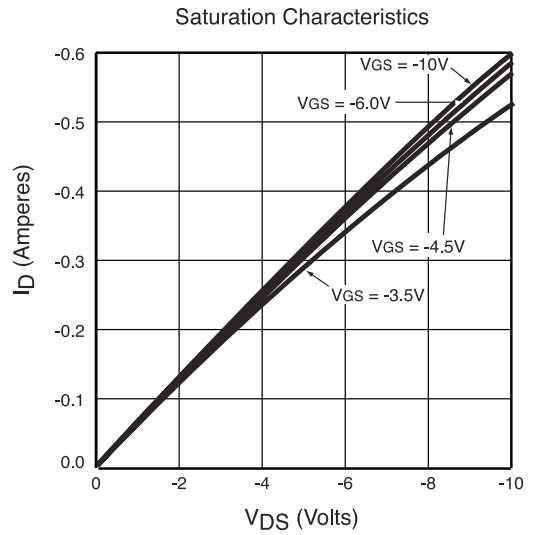
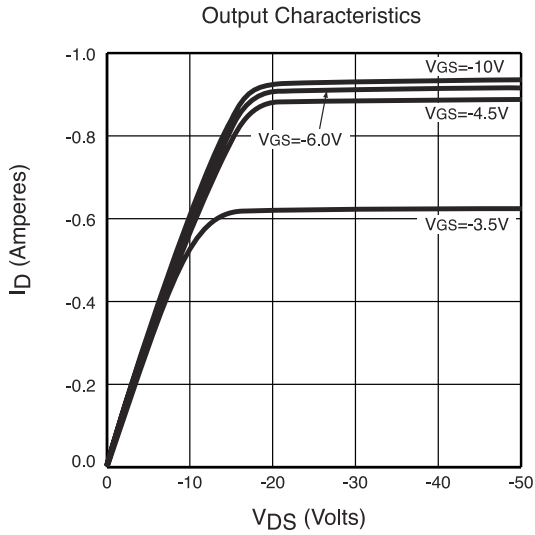

Typical Performance Curves (cont.)

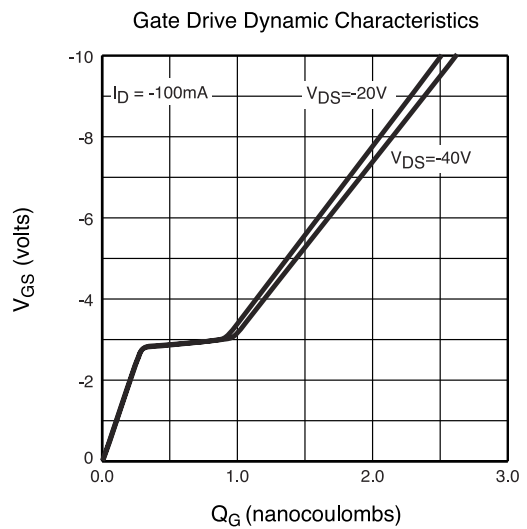
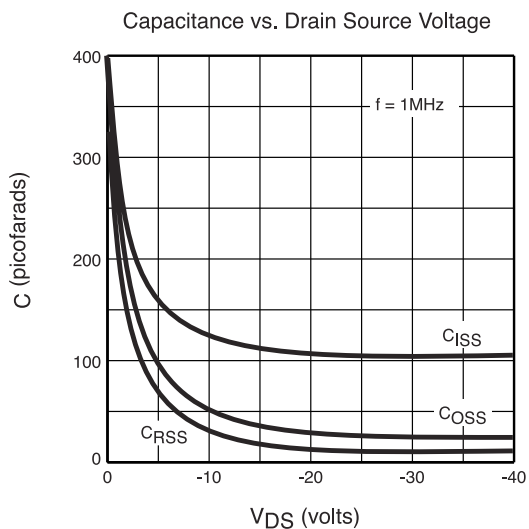
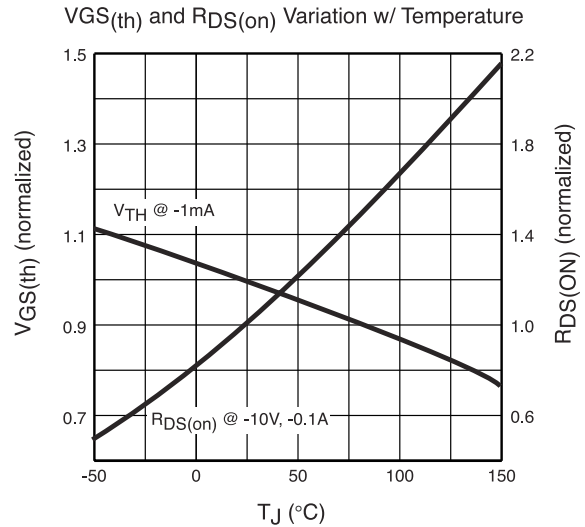
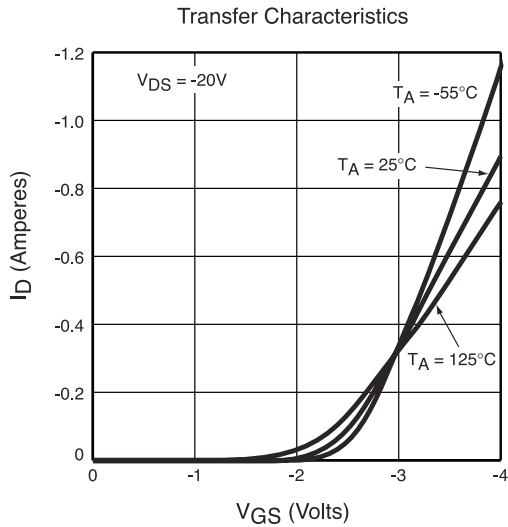
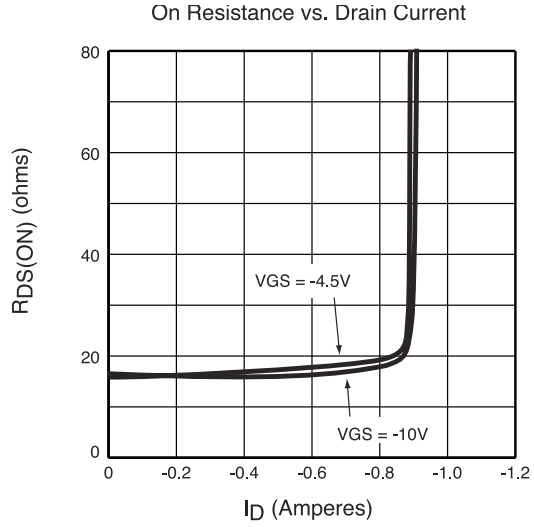
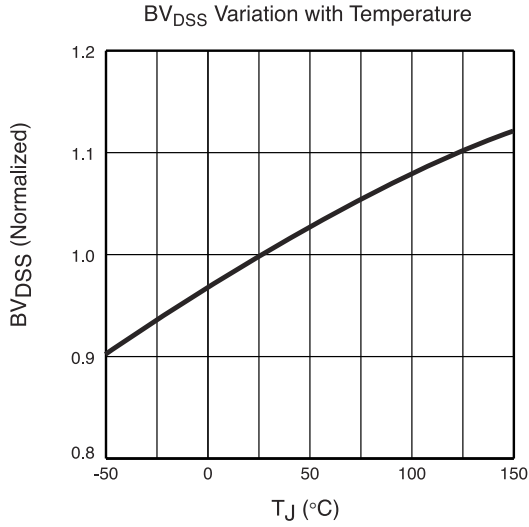

### 3-Lead TO-92 Package Outline (N3)

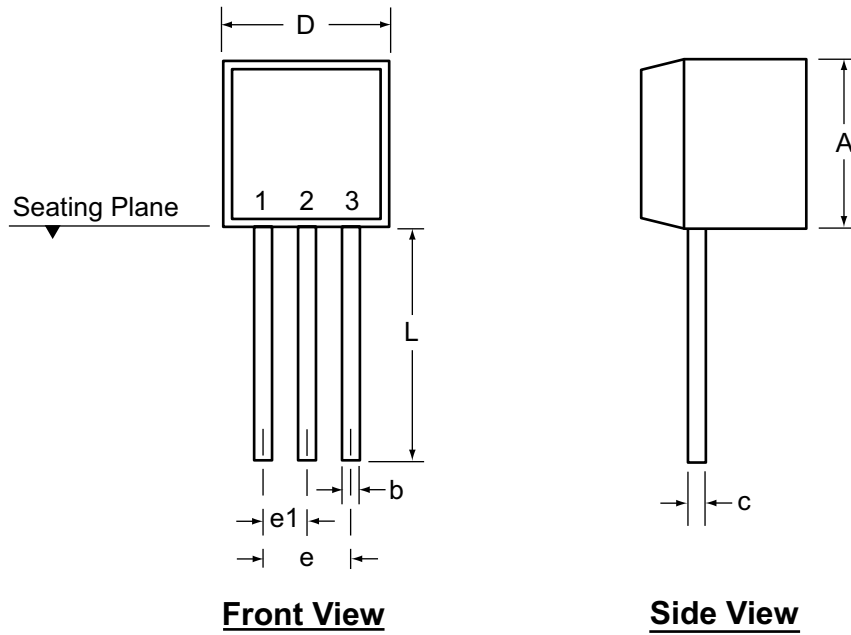

**Front View**

**Side View**

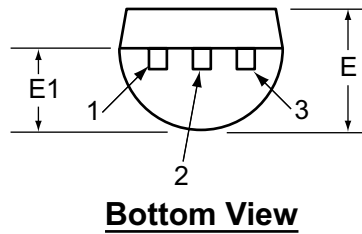

**Bottom View**

Symbol	A	b	c	D	E	E1	e	e1	L	
Dimensions (inches)	MIN	.170	.014 <sup>†</sup>	.014 <sup>†</sup>	.175	.125	.080	.095	.045	.500
	NOM	-	-	-	-	-	-	-	-	-
	MAX	.210	.022 <sup>†</sup>	.022 <sup>†</sup>	.205	.165	.105	.105	.055	.610*

JEDEC Registration TO-92.

\* This dimension is not specified in the original JEDEC drawing. The value listed is for reference only.

† This dimension is a non-JEDEC dimension.

Drawings not to scale.

Supertex Doc.#: DSPD-3TO92N3, Version D080408.

### 3-Lead TO-243AA (SOT-89) Package Outline (N8)

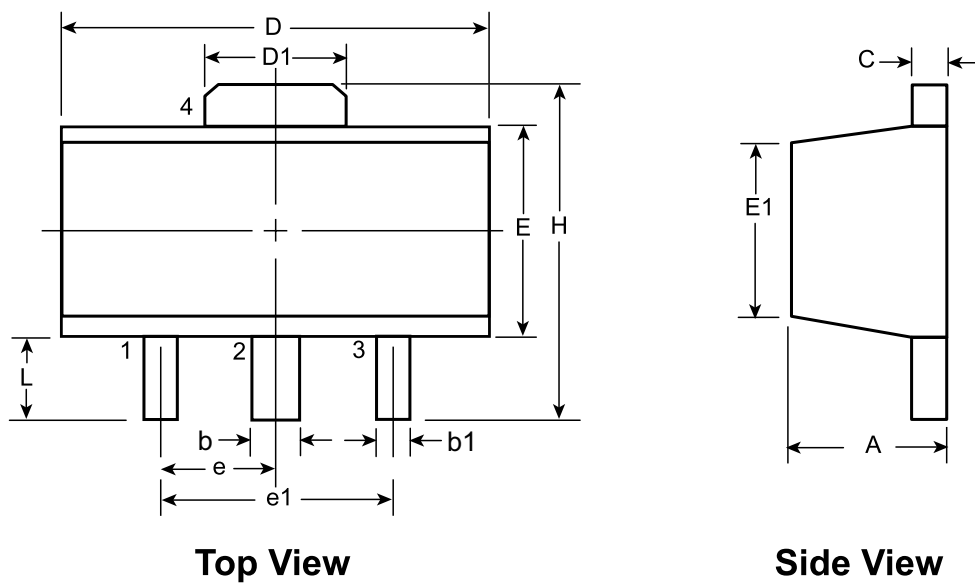

**Top View**

**Side View**

Symbol		A	b	b1	C	D	D1	E	E1	e	e1	H	L	
Dimensions (mm)	MIN	1.40	0.44	0.36	0.35	4.40	1.62	2.29	2.13	1.50 BSC	3.00 BSC	3.94	0.89	
	NOM	-	-	-	-	-	-	-	-			-	-	-
	MAX	1.60	0.56	0.48	0.44	4.60	1.83	2.60	2.29			4.25	1.20	

JEDEC Registration TO-243, Variation AA, Issue C, July 1986.

Drawings not to scale.

Supertex Doc. #: DSPD-3TO243AAN8, Version D070908.

(The package drawing(s) in this data sheet may not reflect the most current specifications. For the latest package outline information go to <http://www.supertex.com/packaging.html>.)

Supertex inc. does not recommend the use of its products in life support applications, and will not knowingly sell them for use in such applications unless it receives an adequate "product liability indemnification insurance agreement." Supertex inc. does not assume responsibility for use of devices described, and limits its liability to the replacement of the devices determined defective due to workmanship. No responsibility is assumed for possible omissions and inaccuracies. Circuitry and specifications are subject to change without notice. For the latest product specifications refer to the Supertex inc. website: <http://www.supertex.com>.