

Precision Voltage Reference

FEATURES

- ◆ Very High Accuracy: ± 3 V Output, ± 0.2 mV
- ◆ Extremely Low Drift: 0.6 ppm/°C (-55°C to +125°C)
- ◆ Low Warm-up Drift: 1 ppm Typical
- ◆ Excellent Stability: 6 ppm/1000 Hrs. Typical
- ◆ Excellent Line Regulation: 3 ppm/V Typical
- ◆ Hermetic 14-pin Ceramic DIP
- ◆ Military Processing Option

APPLICATIONS

- ◆ Precision A/D and D/A Converters
- ◆ Transducer Excitation
- ◆ Accurate Comparator Threshold Reference
- ◆ High Resolution Servo Systems
- ◆ Digital Voltmeters
- ◆ High Precision Test and Measurement Instruments

DESCRIPTION

VRE117/119 Series Precision Voltage References provide ultrastable +3 V (VRE117), and ± 3 V (VRE119) output with ± 0.2 mV initial accuracy and temperature coefficient as low as 0.6 ppm/°C over the full military temperature range. This improvement in accuracy is made possible by a unique, proprietary multipoint laser compensation technique. Significant improvements have been made in other performance parameters as well, including initial accuracy, warm-up drift, line regulation, and long-term stability, making the VRE117/119 series the most accurate and stable 3 V reference available.

VRE117/119 devices are available in two operating temperature ranges, -25°C to +85°C and -55°C to +125°C, and two performance grades. All devices are packaged in 14-pin hermetic ceramic packages for maximum long-term stability. "M" versions are screened for high reliability and quality.

Superior stability, accuracy, and quality make these references ideal for precision applications such as A/D and D/A converters, high-accuracy test and measurement instrumentation, and transducer excitation.

Figure 1. BLOCK DIAGRAMS

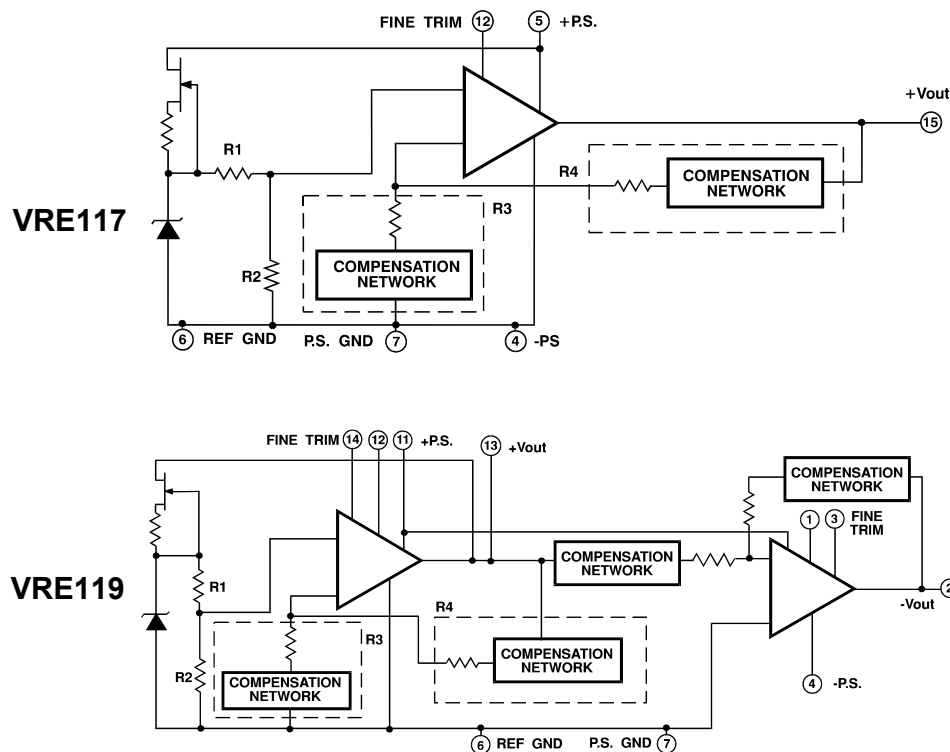

SELECTION GUIDE

Model	Output (V)	Temperature Operating Range	Volt Deviation (MAX)
VRE117M	+3	-55°C to +125°C	±400µV
VRE117MA	+3	-55°C to +125°C	±200µV
VRE119C	±3	-25°C to +85°C	±200µV



Hermetic 14-pin Ceramic DIP
Package Style HC

1. CHARACTERISTICS AND SPECIFICATIONS

ELECTRICAL SPECIFICATIONS

$V_{PS} = \pm 15V$, $T = +25^\circ C$, $R_L = 10K \Omega$ UNLESS OTHERWISE NOTED.

Model	VRE119C			VRE117M			VRE117MA			Units
	Min	Typ	Max	Min	Typ	Max	Min	Typ	Max	
ABSOLUTE MAXIMUM RATINGS										
Power Supply	±13.5		±22	*		*	*		*	V
Operating Temperature	-25		+85	-55		+125	-55		+125	°C
Storage Temperature	-65		+150	*		*	*		*	°C
Short Circuit Protection	Continuous			*			*			
OUTPUT VOLTAGE										
VRE117		+3.0			*			*		V
VRE119		±3.0			*			*		V
OUTPUT VOLTAGE ERRORS										
Initial Error			±300			±300			±200	µV
Warmup Drift		2			2			1		ppm
$T_{MIN} - T_{MAX}$ (Note 1)			200			400			200	µV
Long-Term Stability		6			*			*		ppm/1000hrs.
Noise (0.1 - 10Hz)		1.5			*			*		µVpp
OUTPUT CURRENT										
Range	±10			*			*			mA
REGULATION										
Line		3	10		*	*		*	*	ppm/V
Load		3			*			*		ppm/mA
OUTPUT ADJUSTMENT										
Range		5			*			*		mV
Temperature Coefficient		1			*			*		µV/°C/mV
POWER SUPPLY CURRENT (Note 2)										
VRE117 ±PS		5	7		*	*		*	*	mA
VRE119 +PS		7	9		*	*		*	*	mA
VRE119 -PS		4	6		*	*		*	*	mA

NOTES:

* Same as C Models.

- Using the box method, the specified value is the maximum deviation from the output voltage at 25°C over the specified operating temperature range.
- The specified values are unloaded.

2. TYPICAL PERFORMANCE GRAPHS

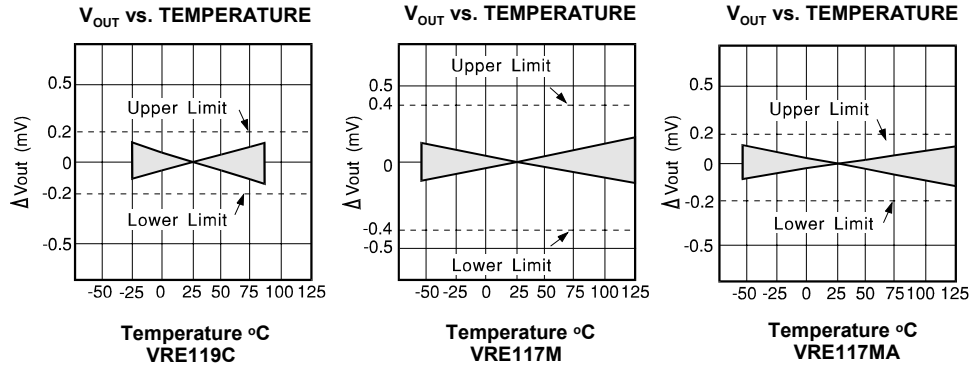

VRE117

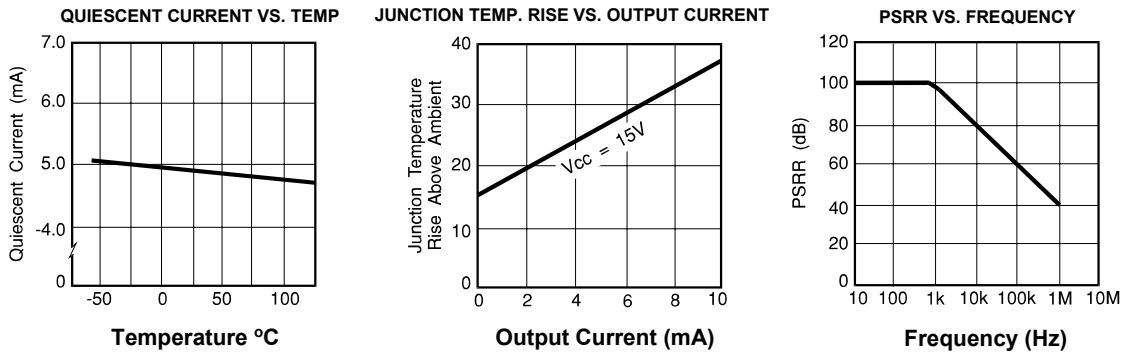

VRE119

POSITIVE OUTPUT

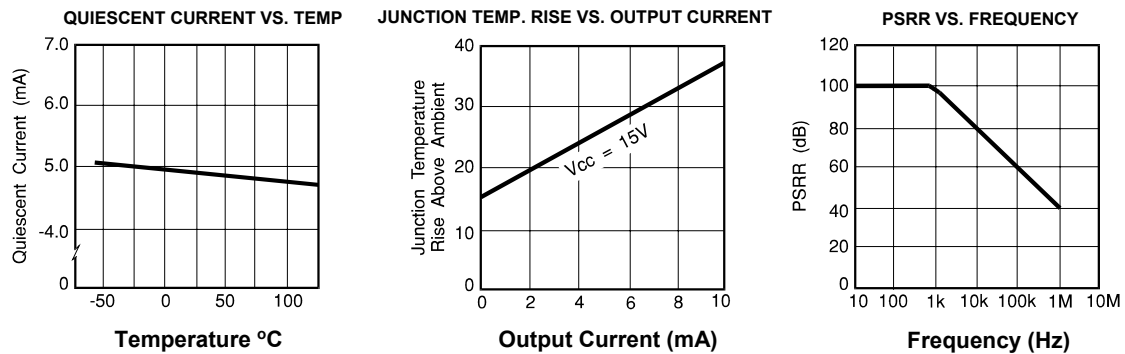

NEGATIVE OUTPUT

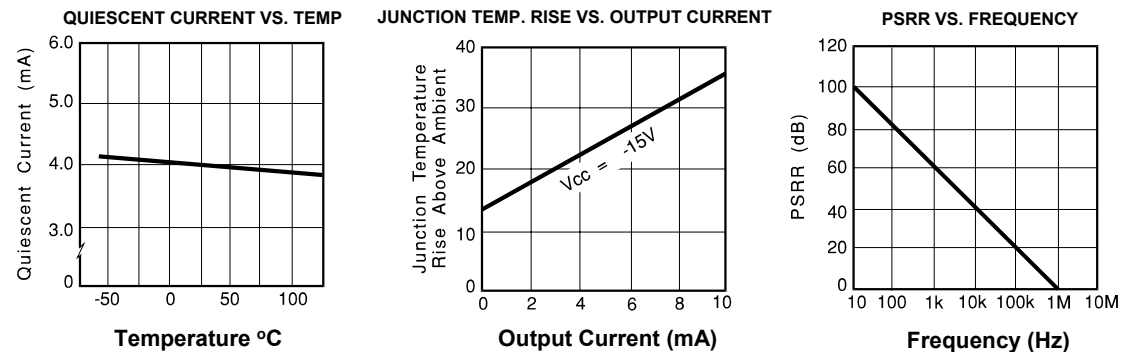

3. THEORY OF OPERATION

The following discussion refers to the block diagram in Figure 1. A FET current source is used to bias a 6.3 V zener diode. The zener voltage is divided by the resistor network R1 and R2. This voltage is then applied to the noninverting input of the operational amplifier which amplifies the voltage to produce a 3 V output. The gain is determined by the resistor networks R3 and R4: $G=1 + R4/R3$. The 6.3 V zener diode is used because it is the most stable diode over time and temperature.

The current source provides a closely regulated zener current, which determines the slope of the reference's voltage vs. temperature function. By trimming the zener current, a lower drift over temperature can be achieved. But since the voltage vs. temperature function is nonlinear, this method leaves a residual error over wide temperature ranges.

To remove this residual error, a nonlinear compensation network of thermistors and resistors is used in the VRE117/119 series references. This proprietary network eliminates most of the nonlinearity in the voltage vs. temperature function. By then adjusting the slope, The VRE117/119 series produces a very stable voltage over wide temperature ranges. This network is less than 2% of the overall network resistance so it has a negligible effect on long term stability.

4. APPLICATION INFORMATION

The proper connection of the VRE117 series voltage reference with the optional trim resistors is shown below. When trimming the VRE119, the positive voltage should be trimmed first since the negative voltage tracks the positive side. Pay careful attention to the circuit layout to avoid noise pickup and voltage drops in the lines.

The VRE117/119 series voltage references have the ground terminal brought out on two pins (pin 6 and pin 7) which are connected together internally. This allows the user to achieve greater accuracy when using a socket. Voltage references have a voltage drop across their power supply ground pin due to quiescent current flowing through the contact resistance. If the contact resistance was constant with time and temperature, this voltage drop could be trimmed out. When the reference is plugged into a socket, this source of error can be as high as 20 ppm. By connecting pin 7 to the power supply ground and pin 6 to a high impedance ground point in the measurement circuit, the error due to the contact resistance can be eliminated. If the unit is soldered into place the contact resistance is sufficiently small that it doesn't effect performance.

EXTERNAL CONNECTIONS

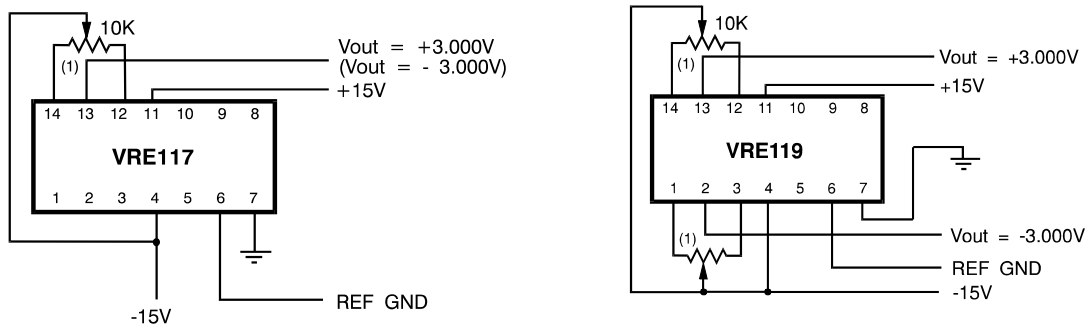

1. Optional Fine Adjust for approximately ±5mV.

PIN CONFIGURATION

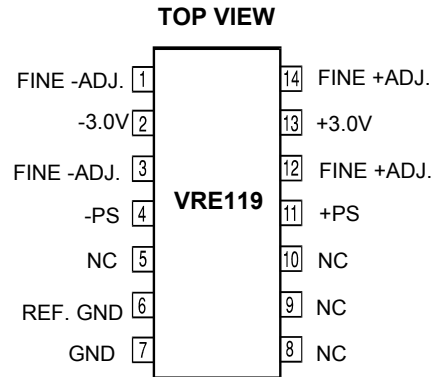
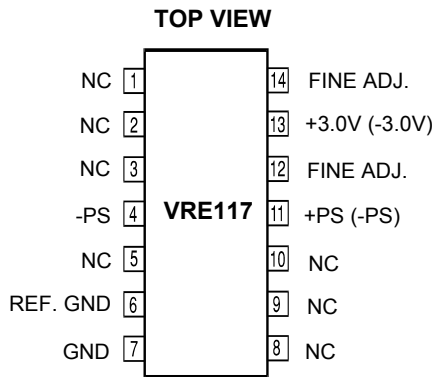

CONTACTING CIRRUS LOGIC SUPPORT

For all Apex Precision Power product questions and inquiries, call toll free 800-546-2739 in North America.

For inquiries via email, please contact tucson.support@cirrus.com.

International customers can also request support by contacting their local Cirrus Logic Sales Representative.

To find the one nearest to you, go to www.cirrus.com

IMPORTANT NOTICE

Cirrus Logic, Inc. and its subsidiaries ("Cirrus") believe that the information contained in this document is accurate and reliable. However, the information is subject to change without notice and is provided "AS IS" without warranty of any kind (express or implied). Customers are advised to obtain the latest version of relevant information to verify, before placing orders, that information being relied on is current and complete. All products are sold subject to the terms and conditions of sale supplied at the time of order acknowledgment, including those pertaining to warranty, indemnification, and limitation of liability. No responsibility is assumed by Cirrus for the use of this information, including use of this information as the basis for manufacture or sale of any items, or for infringement of patents or other rights of third parties. This document is the property of Cirrus and by furnishing this information, Cirrus grants no license, express or implied under any patents, mask work rights, copyrights, trademarks, trade secrets or other intellectual property rights. Cirrus owns the copyrights associated with the information contained herein and gives consent for copies to be made of the information only for use within your organization with respect to Cirrus integrated circuits or other products of Cirrus. This consent does not extend to other copying such as copying for general distribution, advertising or promotional purposes, or for creating any work for resale.

CERTAIN APPLICATIONS USING SEMICONDUCTOR PRODUCTS MAY INVOLVE POTENTIAL RISKS OF DEATH, PERSONAL INJURY, OR SEVERE PROPERTY OR ENVIRONMENTAL DAMAGE ("CRITICAL APPLICATIONS"). CIRRUS PRODUCTS ARE NOT DESIGNED, AUTHORIZED OR WARRANTED TO BE SUITABLE FOR USE IN PRODUCTS SURGICALLY IMPLANTED INTO THE BODY, AUTOMOTIVE SAFETY OR SECURITY DEVICES, LIFE SUPPORT PRODUCTS OR OTHER CRITICAL APPLICATIONS. INCLUSION OF CIRRUS PRODUCTS IN SUCH APPLICATIONS IS UNDERSTOOD TO BE FULLY AT THE CUSTOMER'S RISK AND CIRRUS DISCLAIMS AND MAKES NO WARRANTY, EXPRESS, STATUTORY OR IMPLIED, INCLUDING THE IMPLIED WARRANTIES OF MERCHANTABILITY AND FITNESS FOR PARTICULAR PURPOSE, WITH REGARD TO ANY CIRRUS PRODUCT THAT IS USED IN SUCH A MANNER. IF THE CUSTOMER OR CUSTOMER'S CUSTOMER USES OR PERMITS THE USE OF CIRRUS PRODUCTS IN CRITICAL APPLICATIONS, CUSTOMER AGREES, BY SUCH USE, TO FULLY INDEMNIFY CIRRUS, ITS OFFICERS, DIRECTORS, EMPLOYEES, DISTRIBUTORS AND OTHER AGENTS FROM ANY AND ALL LIABILITY, INCLUDING ATTORNEYS' FEES AND COSTS, THAT MAY RESULT FROM OR ARISE IN CONNECTION WITH THESE USES.

Cirrus Logic, Cirrus, and the Cirrus Logic logo designs, Apex Precision Power, Apex and the Apex Precision Power logo designs are trademarks of Cirrus Logic, Inc. All other brand and product names in this document may be trademarks or service marks of their respective owners.