

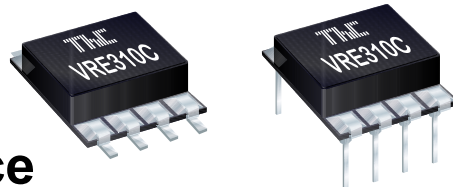

VRE310

Low Cost Precision Reference



THALER CORPORATION • 2015 N. FORBES BOULEVARD • TUCSON, AZ. 85745 • (520) 882-4000

FEATURES

- 10.000 V OUTPUT \pm 1.000 mV (.01%)
- TEMPERATURE DRIFT: 0.6 ppm/ $^{\circ}$ C
- LOW NOISE: 6 μ V_{p-p} (0.1-10Hz)
- INDUSTRY STD PINOUT- 8 PIN DIP OR SURFACE MOUNT PACKAGE
- EXCELLENT LINE REGULATION: 6ppm/V Typ.
- OUTPUT TRIM CAPABILITY

PIN CONFIGURATION

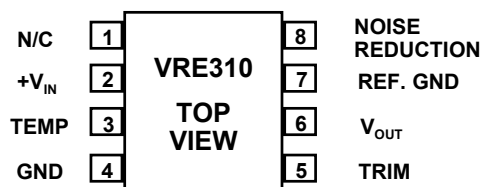

FIGURE 1

DESCRIPTION

The VRE310 is a low cost, high precision 10.0V reference. Packaged in the industry standard 8 pin DIP, the device is ideal for upgrading systems that use lower performance references.

The device provides ultrastable +10.000V output with \pm 1.000 mV (.01%) initial accuracy and a temperature coefficient of 0.6 ppm/ $^{\circ}$ C. This improvement in accuracy is made possible by a unique, patented multipoint laser compensation technique developed by Thaler Corporation. Significant improvements have been made in other performance parameters as well, including initial accuracy, warm-up drift, line regulation, and long-term stability, making the VRE310 series the most accurate reference available in the standard 8 pin DIP package.

For enhanced performance, the VRE310 has an external trim option for users who want less than 0.01% initial error. For ultra low noise applications, an external capacitor can be attached between the noise reduction pin and the ground pin. A reference ground pin is provided to eliminate socket contact resistance errors.

The VRE310 is recommended for use as a reference for 14-, 16-, or 18-bit D/A converters which require an external precision reference. The device is also ideal for calibrating scale factor on high resolution A/D converters. The VRE310 offers superior performance over monolithic references.

SELECTION GUIDE

| Model | Initial Error mV | Temp. Coeff. ppm/ $^{\circ}$ C | Temp. Range $^{\circ}$ C |
|---------|------------------|--------------------------------|--------------------------------------|
| VRE310A | 1.0 | 0.6 | 0 $^{\circ}$ C to +70 $^{\circ}$ C |
| VRE310B | 1.6 | 1.0 | 0 $^{\circ}$ C to +70 $^{\circ}$ C |
| VRE310C | 2.0 | 2.0 | 0 $^{\circ}$ C to +70 $^{\circ}$ C |
| VRE310J | 1.0 | 0.6 | -40 $^{\circ}$ C to +85 $^{\circ}$ C |
| VRE310K | 1.6 | 1.0 | -40 $^{\circ}$ C to +85 $^{\circ}$ C |
| VRE310L | 2.0 | 2.0 | -40 $^{\circ}$ C to +85 $^{\circ}$ C |

For package option add D for DIP or S for Surface Mount to end of model number.

ELECTRICAL SPECIFICATIONS

VRE310

Vps =+15V, T = 25°C, RL = 10KΩ unless otherwise noted.

| MODEL | A/J | | | B/K | | | C/L | | | |
|--|------------|--------|------|-----|-----|------|-----|-----|------|-------------|
| PARAMETER | MIN | TYP | MAX | MIN | TYP | MAX | MIN | TYP | MAX | UNITS |
| ABSOLUTE RATINGS | | | | | | | | | | |
| Power Supply | +13.5 | +15 | +22 | * | * | * | * | * | * | V |
| Operating Temp. (A,B,C) | 0 | | +70 | * | | * | * | | * | °C |
| Operating Temp. (J,K,L) | -40 | | +85 | * | | * | * | | * | °C |
| Storage Temperature | -65 | | +150 | * | | * | * | | * | °C |
| Short Circuit Protection | Continuous | | | | * | | | * | | |
| OUTPUT VOLTAGE | | | | | | | | | | |
| VRE310 | | 10.000 | | | * | | | * | | V |
| Temp. Sensor Voltage ⁽¹⁾ | | 630 | | | * | | | * | | mV |
| OUTPUT VOLTAGE ERRORS | | | | | | | | | | |
| Initial Error ⁽²⁾ | | | 1.00 | | | 1.60 | | | 2.00 | mV |
| Warmup Drift | | 1 | | | 2 | | | 3 | | ppm |
| T _{min} - T _{max} ⁽³⁾ | | | 0.6 | | * | 1.0 | | * | 2.0 | ppm/°C |
| Long-Term Stability | | 6 | | | * | | | * | | ppm/1000hrs |
| Noise (.1-10Hz) ⁽⁴⁾ | | 6 | | | * | | | * | | μVpp |
| OUTPUT CURRENT | | | | | | | | | | |
| Range | ±10 | | | * | | | * | | | mA |
| REGULATION | | | | | | | | | | |
| Line | | 3 | 10 | | * | * | | * | * | ppm/V |
| Load | | 3 | | | * | | | * | | ppm/mA |
| OUTPUT ADJUSTMENT | | | | | | | | | | |
| Range | | 20 | | | * | | | * | | mV |
| POWER SUPPLY CURRENTS ⁽⁵⁾ | | | | | | | | | | |
| VRE310 +PS | | 5 | 7 | | * | * | | * | * | mA |

NOTES: *Same as A/J Models.

- The temp. reference TC is 2.1mV/°C
- The specified values are without external trim.
- The temperature coefficient is determined by the box method using the following formula:

$$T.C. = \frac{V_{max} - V_{min}}{V_{nominal} \times (T_{max} - T_{min})} \times 10^6$$

4. The specified values are without the external noise reduction capacitor.

5. The specified values are unloaded.

TYPICAL PERFORMANCE CURVES

V_{OUT} vs. TEMPERATURE

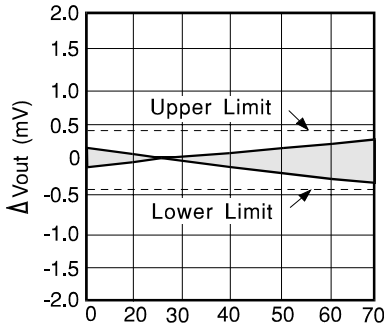

**Temperature °C
VRE310A**

V_{OUT} vs. TEMPERATURE

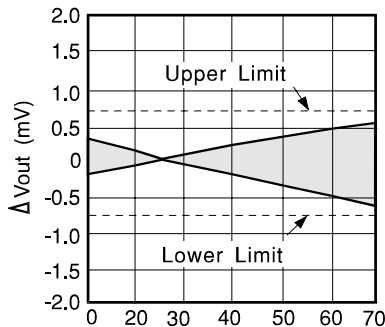

**Temperature °C
VRE310B**

V_{OUT} vs. TEMPERATURE

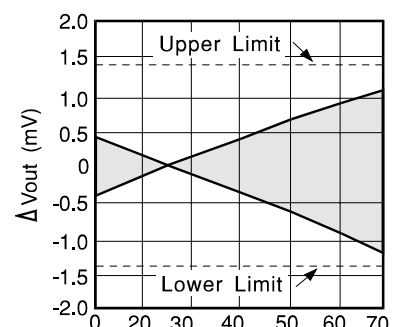

**Temperature °C
VRE310C**

V_{OUT} vs. TEMPERATURE

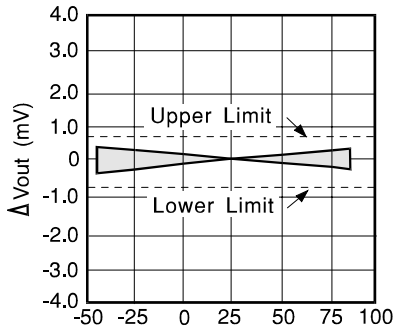

**Temperature °C
VRE310J**

V_{OUT} vs. TEMPERATURE

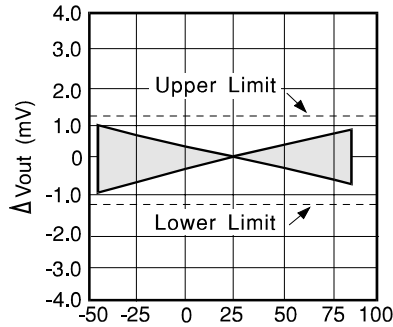

**Temperature °C
VRE310K**

V_{OUT} vs. TEMPERATURE

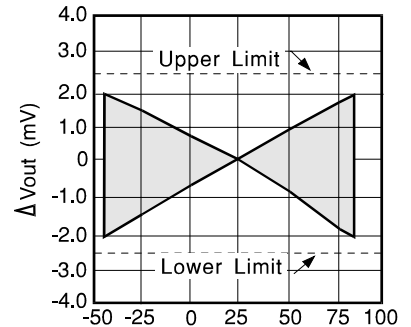

**Temperature °C
VRE310L**

QUIESCENT CURRENT vs. TEMP

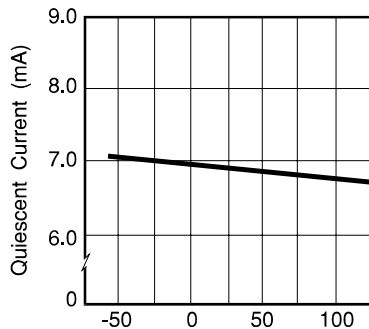

Temperature °C

JUNCTION TEMP. RISE vs. OUTPUT CURRENT

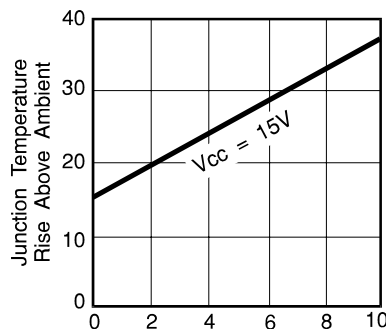

Output Current (mA)

PSRR vs. FREQUENCY

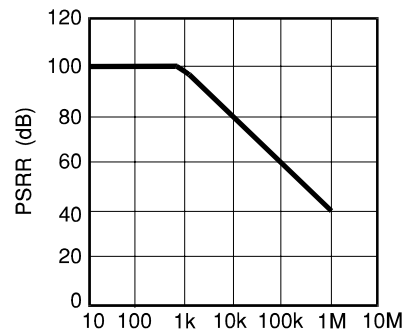

Frequency (Hz)

DISCUSSION OF PERFORMANCE

THEORY OF OPERATION

The following discussion refers to the schematic in figure 2 below. In operation, approximately 6.3 volts is applied to the noninverting input of the op amp. The voltage is amplified by the op amp to produce a 10.000V output. The gain is determined by the networks R1 and R2: $G=1 + R2/R1$. The 6.3V zener diode is used because it is the most stable diode over time and temperature.

The zener operating current is derived from the regulated output voltage through R3. This feedback arrangement provides a closely regulated zener current. This current determines the slope of the references' voltage vs. temperature function. By trimming the zener current a lower drift over temperature can be achieved. But since the voltage vs. temperature function is nonlinear this compensation technique is not well suited for wide temperature ranges.

Thaler Corporation has developed a nonlinear compensation network of thermistors and resistors that is used in the VRE series voltage references. This proprietary network eliminates most of the nonlinearity in the voltage vs. temperature function. By then adjusting the slope, Thaler Corporation produces a very stable voltage over wide temperature ranges.

This network is less than 2% of the overall network resistance so it has a negligible effect on long term stability. By using highly stable resistors in our network, we produce a voltage reference that also has very good long term stability

Figure 3 shows the proper connection of the VRE310 series voltage references with the optional trim resistor. The VRE310 reference has the ground terminal brought out on two pins (pin 4 and pin 7) which are connected together internally. This allows the user to achieve greater accuracy when using a socket. Voltage references have a voltage drop across their power supply ground pin due to quiescent current flowing through the contact resistance. If the contact resistance was constant with time and temperature, this voltage drop could be trimmed out. When the reference is plugged into a socket, this source of error can be as high as 20ppm. By connecting pin 4 to the power supply ground and pin 7 to a high impedance ground point in the measurement circuit, the error due to the contact resistance can be eliminated. If the unit is soldered into place, the contact resistance is sufficiently small that it does not effect performance. Pay careful attention to the circuit layout to avoid noise pickup and voltage drops in the lines.

VRE310

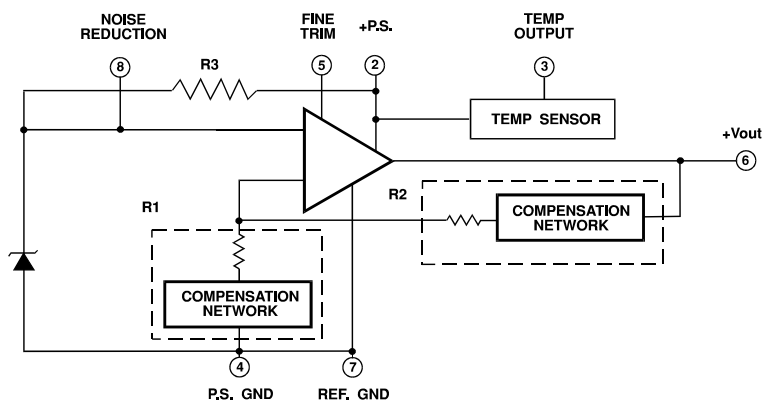

FIGURE 2

EXTERNAL CONNECTIONS

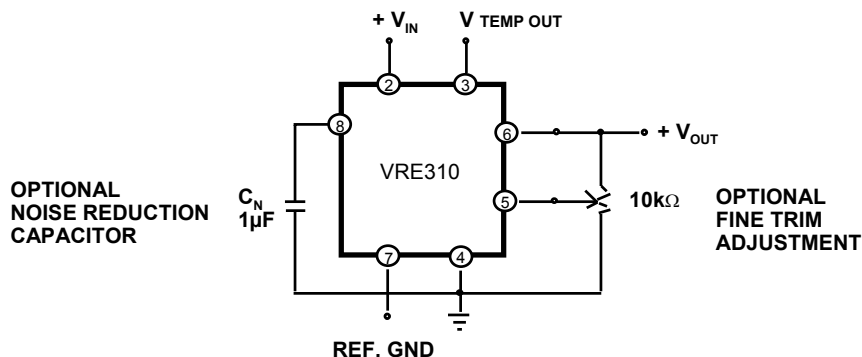
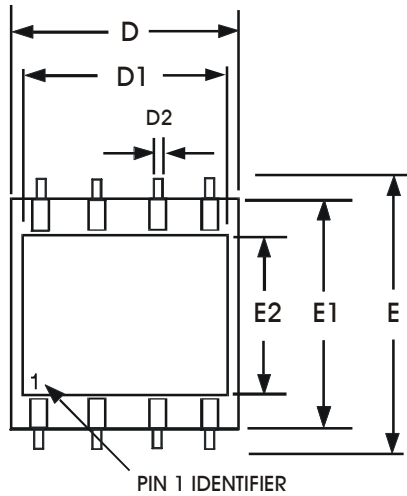

FIGURE 3

MECHANICAL

FIGURE 3



| DIM | INCHES | | MILLIMETER | | DIM | INCHES | | MILLIMETER | |
|-----|--------|------|------------|------|-----|--------|------|------------|------|
| | MIN | MAX | MIN | MAX | | MIN | MAX | MIN | MAX |
| A | .115 | .125 | 2.92 | 3.17 | D2 | .018 | .023 | 0.46 | 0.58 |
| B | .098 | .102 | 2.48 | 2.59 | E | .507 | .513 | 12.8 | 13.0 |
| B1 | .046 | .051 | 1.14 | 1.29 | E1 | .397 | .403 | 10.0 | 10.2 |
| C | .107 | .113 | 2.71 | 2.89 | E2 | .264 | .270 | 6.70 | 6.85 |
| C1 | .009 | .012 | 0.22 | 0.30 | P | .085 | .095 | 2.15 | 2.41 |
| C2 | .052 | .058 | 1.32 | 1.47 | Q | .020 | .030 | .508 | .762 |
| D | .397 | .403 | 10.0 | 10.2 | S | .045 | .055 | 1.14 | 1.39 |
| D1 | .372 | .380 | 9.44 | 9.65 | | | | | |

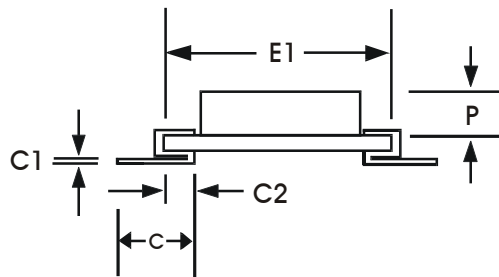
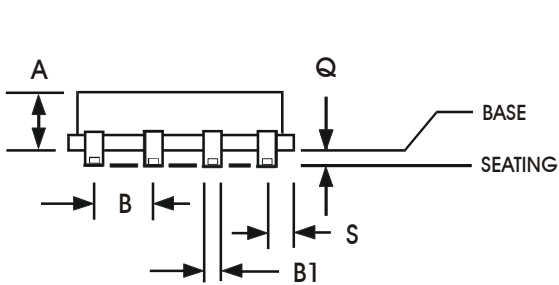
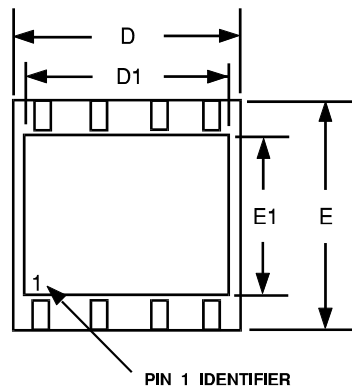

FIGURE 4



| DIM | INCHES | | MILLIMETER | | DIM | INCHES | | MILLIMETER | |
|-----|--------|------|------------|------|-----|--------|------|------------|------|
| | MIN | MAX | MIN | MAX | | MIN | MAX | MIN | MAX |
| A | .115 | .125 | 2.92 | 3.17 | E | .397 | .403 | 10.0 | 10.2 |
| B | .018 | .022 | .457 | .558 | E1 | .264 | .270 | 6.70 | 6.85 |
| B1 | .046 | .051 | 1.14 | 1.29 | G1 | .290 | .310 | 7.36 | 7.87 |
| B2 | .098 | .102 | 2.48 | 2.59 | L | .195 | .215 | 4.95 | 5.46 |
| C | .009 | .012 | 0.22 | 0.30 | P | .085 | .095 | 2.15 | 2.41 |
| D | .397 | .403 | 10.0 | 10.2 | Q | .055 | .065 | 1.39 | 1.65 |
| D1 | .372 | .380 | 9.44 | 9.65 | S | .045 | .055 | 1.14 | 1.39 |

