

## VS-500

### Voltage Controlled SAW Oscillator

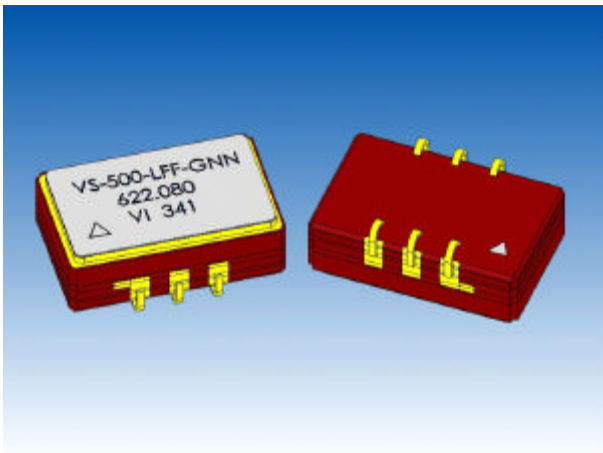

#### Features

- Improved High Performance ASIC
- Industry Standard Package, 9 x 14 x 4.5 mm
- Output Frequencies from 155 MHz to 850 MHz
- 3.3 V or 5.0 V Operation
- At 155.52 MHz, Jitter < 0.50 ps-rms (12 kHz to 20 MHz)
- At 622.08 MHz, Jitter < 0.30 ps-rms (50 kHz to 80 MHz)
- LV-PECL, PECL, or ECL Configurations
- Complementary Outputs
- Output Disable Feature

#### Applications

PLL circuits for Clock Smoothing and Frequency Translation

<u>Description</u>	<u>Standard</u>
• 10G Fibre Channel	INCITS/T11 Project 1413-D
• 10GbE LAN / WAN	IEEE 802.3ae
• OC-192	ITU-T G.709
• SONET / SDH	GR-253-CORE Issue3

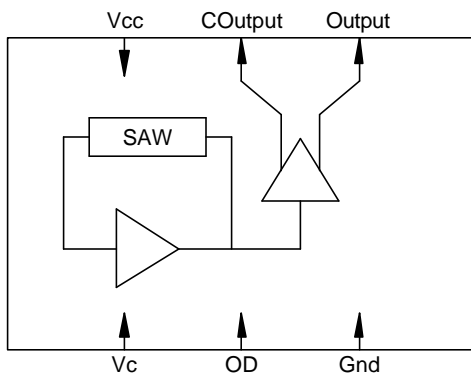

#### Description

The VS-500 is a SAW based voltage controlled oscillator that operates at the fundamental frequency of the internal SAW filter. This resonator is a high Q quartz device that enables the circuit to achieve low phase jitter performance over a wide operating temperature range. The oscillator is housed in a hermetically sealed J-lead surface mount package offered on tape and reel. It has an output disable to facilitate on-board testing.

# VS-500 Voltage Controlled SAW Oscillator

Electrical Performance						
Parameter	Symbol	Minimum	Typical	Maximum	Units	Notes
<b>Frequency</b>						
Nominal Frequency	$f_N$		150 - 850		MHz	1,2,3
Absolute Pull Range	APR	$\pm 50$			ppm	1,2,3,9/10
Linearity	Lin		$\pm 5$		%	2,4,9/10
Gain Transfer @ 155.52 MHz (See Pg 5/6)	$K_V$		+691/+435		ppm/V	2,9/10
Gain Transfer @ 622.08 MHz (See Pg 5/6)	$K_V$		+434/+281		ppm/V	2,9/10
Temperature Stability @ 155.52 MHz	$f_{STAB}$		$\pm 100$		ppm	1,6
Temperature Stability @ 622.08 MHz	$f_{STAB}$		$\pm 150$		ppm	1,6
<b>Supply</b>						
Voltage	$V_{CC}$	2.97/4.5	3.3/5.0	3.63/5.5	V	2,3
Current (No Load)	$I_{CC}$		55	80	mA	3
<b>Outputs</b>						
Mid Level		$V_{CC}-1.5$	$V_{CC}-1.3$	$V_{CC}-1.1$	V	2,3
Swing			850		mV-pp	2,3
Current	$I_{OUT}$			20	mA	6
Rise & Fall Time	$t_R, t_F$		250	400	ps	5,6
Symmetry	SYM	45	50	55	%	2,3
Spurious Suppression		50	60		dBc	6
Jitter @ 155.52 MHz (See Pg 5/6)	$\phi_J$		0.440		ps-rms	6,7
Jitter @ 622.08 MHz (See Pg 5/6)	$\phi_J$		0.230		ps-rms	6,8
<b>Control Voltage</b>						
Input Impedance (LV-PECL or PECL)	$Z_c$		100		k $\Omega$	6
Input Impedance (ECL)	$Z_c$		10		k $\Omega$	6
Modulation Bandwidth	BW		500		kHz	6
<b>Operating Temperature</b>						
	$T_{OP}$	-40		85	$^{\circ}C$	1,3
<b>Package Size</b>						
		9.0 x 14.0 x 4.5			mm	

1. See Standard Frequencies and Ordering Information (Pg 8).
2. Parameters are tested with production test circuit below (Fig 2).
3. Parameters are tested at ambient temperature with test limits guardbanded for specified operating temperature.
4. Measured as the maximum deviation from the best straight-line fit, per MIL-0-55310.
5. Measured from 20% to 80% of a full output swing (Fig 1).
6. Not tested in production, guaranteed by design, verified at qualification.
7. Integrated across 12 kHz to 20 MHz, per GR-253-CORE Issue3.
8. Integrated across 50 kHz to 80 MHz, per GR-253-CORE Issue3.
9. Tested with  $V_c = 0.3V$  to  $3.0V$ .
10. Tested with  $V_c = 0.5V$  to  $4.5V$ .

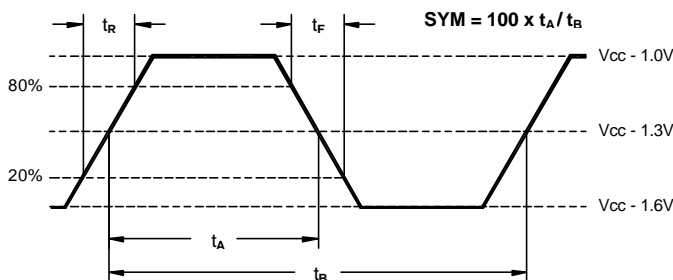
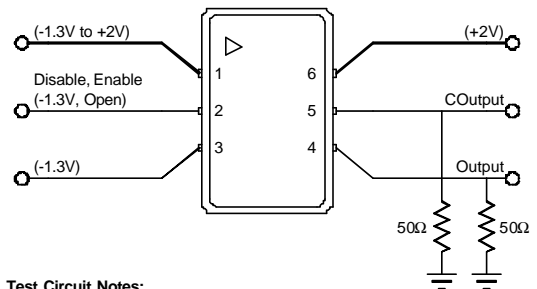

Figure 1. 10K LV-PECL Waveform



- Test Circuit Notes:**
- 1) To Permit 50 $\Omega$  Measurement of Outputs, all DC Inputs are Biased Down 1.3V.
  - 2) All Voltage Sources Contain Bypass Capacitors to Minimize Supply Noise.
  - 3) 50 $\Omega$  Terminations are Within Test Equipment.

Figure 2. 3.3V Test Circuit

# VS-500 Voltage Controlled SAW Oscillator

## Outline Diagram

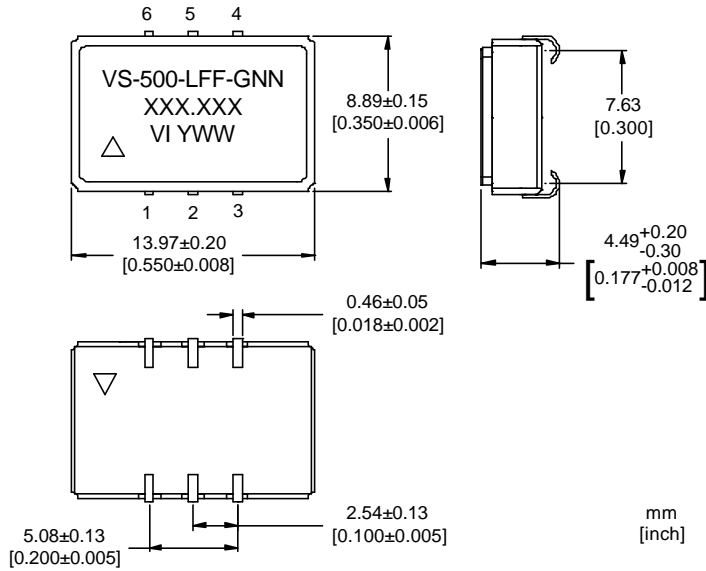

## Pad Layout

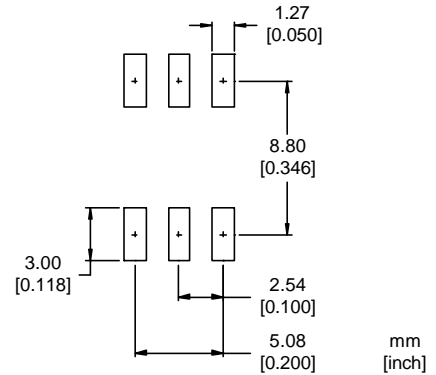

## Pin Out

Pin	Symbol	Function
1	V <sub>c</sub>	VCSO Control Voltage
2	OD	Output Disable* Disabled = LV-CMOS Logic 0 (or GND) Enabled = LV-CMOS Logic 1 (or Open)
3	GND	Case and Electrical Ground
4	Output	VCSO Output
5	COutput	VCSO Complementary Output
6	V <sub>cc</sub>	Power Supply Voltage (3.3V / 5.0V ±10%)

\*For 5.0V Operation, CMOS Levels Should Be Applied.

## Tape and Reel (EIA-481-2-A)

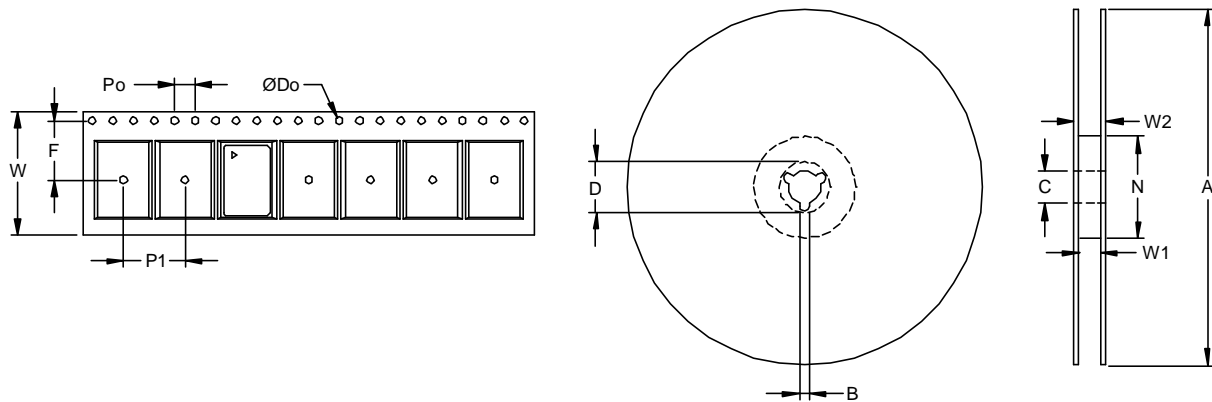

## Tape Dimensions (mm)

## Reel Dimensions (mm)

Dimension	W	F	Do	Po	P1	A	B	C	D	N	W1	W2	# Per Reel
Tolerance	Typ	Typ	Typ	Typ	Typ	Typ	Min	Typ	Min	Min	Typ	Max	
VS-500	24	11.5	1.5	4	12	330	1.5	13	20.2	100	24.4	30.4	200

# VS-500 Voltage Controlled SAW Oscillator

## Absolute Maximum Ratings

Parameter	Symbol	Ratings	Unit
Power Supply	$V_{CC}$	0 to 6	V
Output Current	$I_{out}$	25	mA
Voltage Control Range	$V_C$	0 to $V_{CC}$	V
Storage Temperature	TS	-55 to 125	°C
Soldering Temp/Time	$T_{Ls}$	220/10	°C/sec

Stresses in excess of the absolute maximum ratings can permanently damage the device. Functional operation is not implied at these or any other conditions in excess of conditions represented in the operational sections of this datasheet. Exposure to absolute maximum ratings for extended periods may adversely affect device reliability.

## Suggested Output Load Configurations (3.3V Operation)

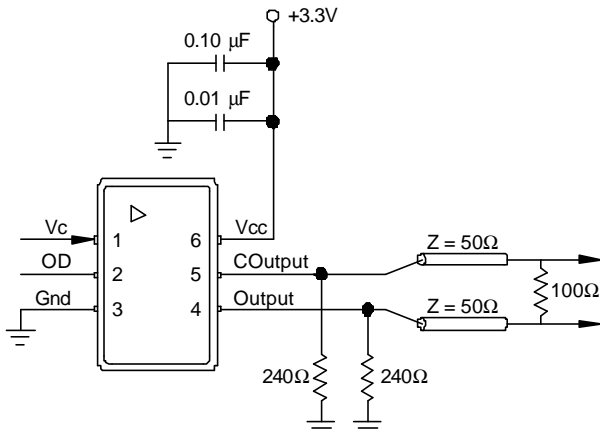

**LV-PECL to LV-PECL:** For short transmission lengths, the power consumption could be reduced by removing the 100Ω resistor and doubling the value of the pull down resistors.

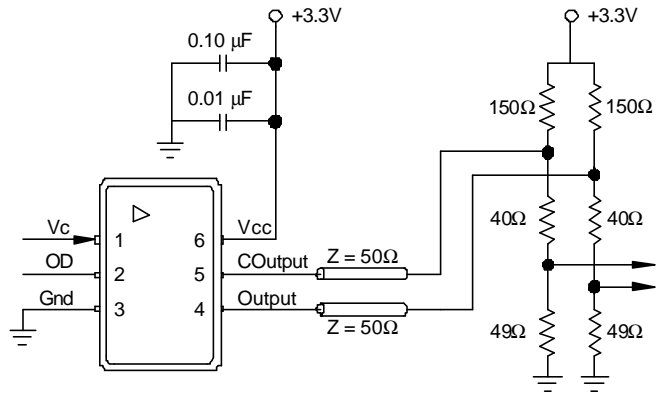

**LV-PECL to LVDS:** Restricted for short transmission lengths. Configuration may require modification depending on LVDS receiver.

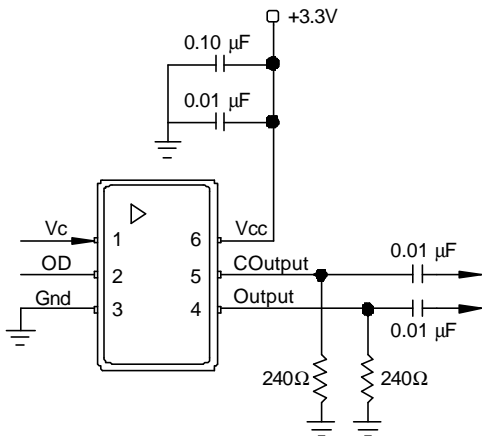

**Functional Test:** Allows standard power supply configuration. Since AC coupled, the LV-PECL levels cannot be measured.

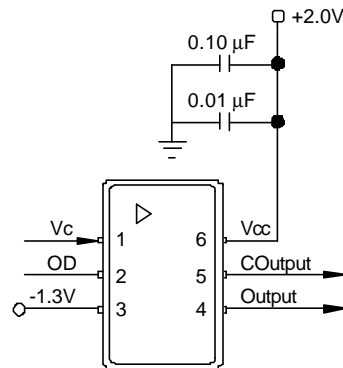

**Production Test:** Allows direct DC coupling into 50Ω measurement equipment. Must bias the power supplies as shown. Similar to Figure 1.

# VS-500 Voltage Controlled SAW Oscillator

## Typical Characteristics (3.3V Operation)

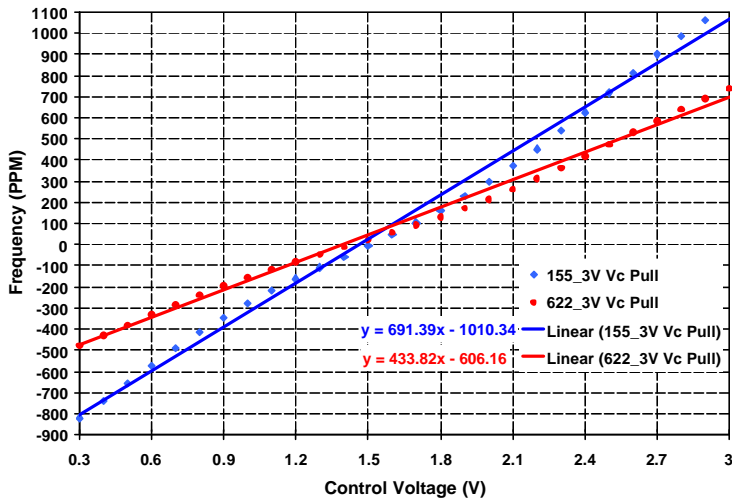

### Vc Pull Characteristics (22.5 °C)

Typical Gain Transfer @ 155.52 = +691 ppm/V

Typical Gain Transfer @ 622.08 = +434 ppm/V

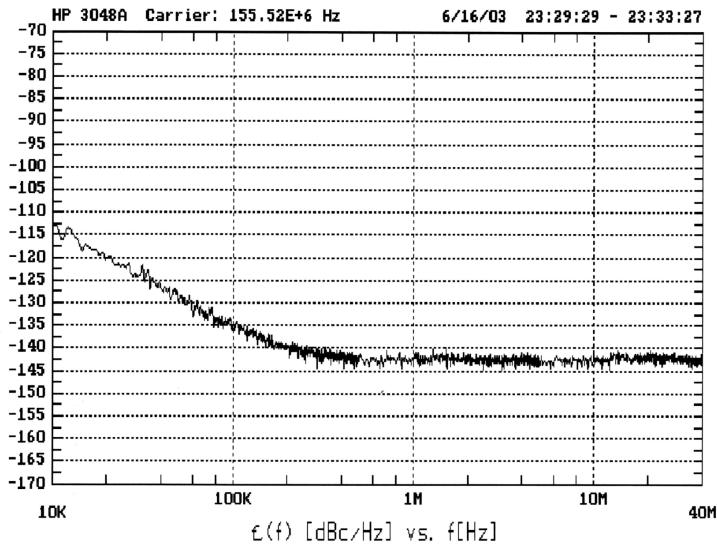

### Calculated Jitter @ 155.52 MHz (22.5 °C)

SONET OC-48 (12kHz-20MHz) = 0.442 ps-rms; 3.09 ps-pp

SONET OC-192 (50kHz-80MHz) = 0.685 ps-rms; 4.80 ps-pp

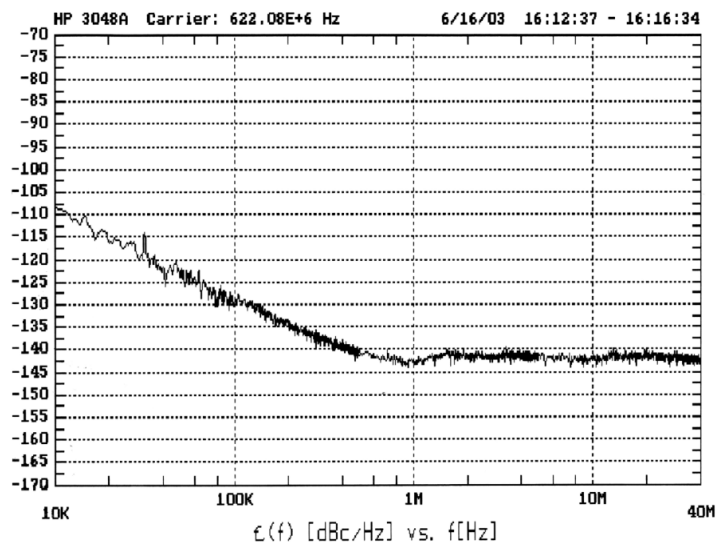

### Calculated Jitter @ 622.08 MHz (22.5 °C)

SONET OC-48 (12kHz-20MHz) = 0.244 ps-rms; 1.71 ps-pp

SONET OC-192 (50kHz-80MHz) = 0.214 ps-rms; 1.50 ps-pp

# VS-500 Voltage Controlled SAW Oscillator

## Typical Characteristics (5.0V Operation)

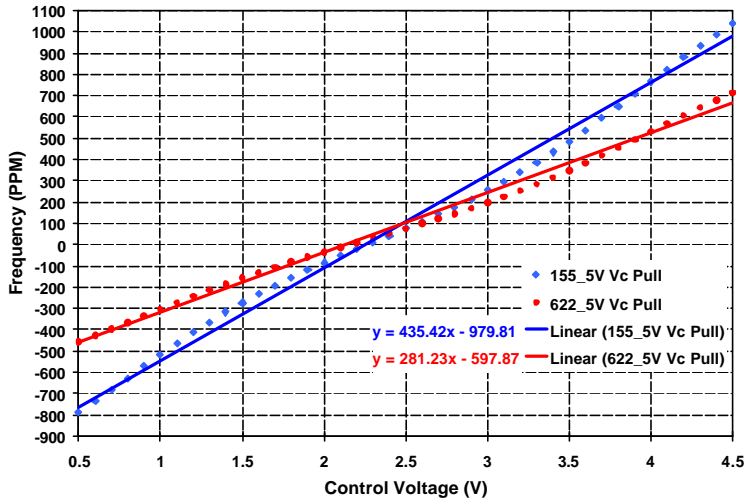

### Vc Pull Characteristics (22.5 °C)

Typical Gain Transfer @ 155.52 = +435 ppm/V

Typical Gain Transfer @ 622.08 = +281 ppm/V

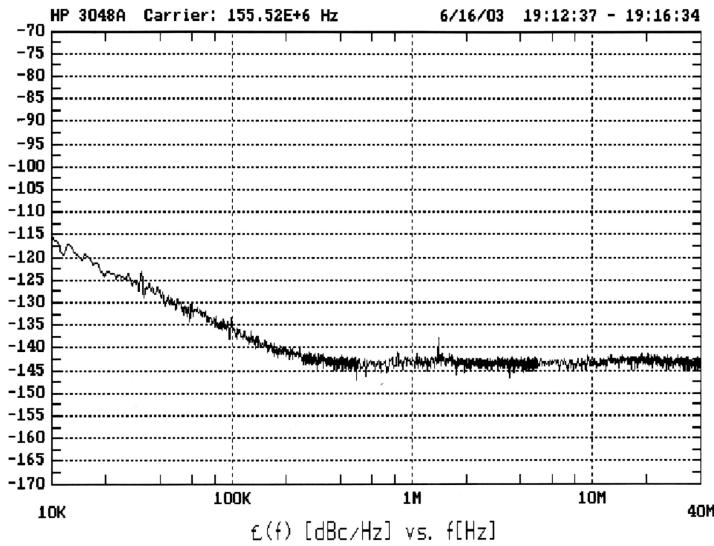

### Calculated Jitter @ 155.52 MHz (22.5 °C)

SONET OC-48 (12kHz-20MHz) = 0.418 ps-rms; 2.93 ps-pp

SONET OC-192 (50kHz-80MHz) = 0.656 ps-rms; 4.59 ps-pp

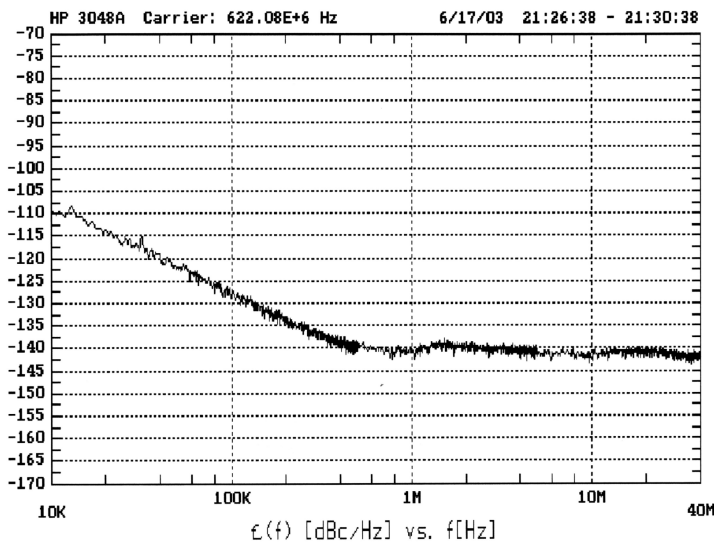

### Calculated Jitter @ 622.08 MHz (22.5 °C)

SONET OC-48 (12kHz-20MHz) = 0.215 ps-rms; 1.51 ps-pp

SONET OC-192 (50kHz-80MHz) = 0.226 ps-rms; 1.58 ps-pp

# VS-500 Voltage Controlled SAW Oscillator

## Reliability

The VS-500 family is capable of meeting the following qualification tests:

### Environmental Compliance

Parameter	Conditions
Mechanical Shock	MIL-STD-883, Method 2002
Mechanical Vibration	MIL-STD-883, Method 2007
Solderability	MIL-STD-883, Method 2003
Gross and Fine Leak	MIL-STD-883, Method 1014
Resistance to Solvents	MIL-STD-883, Method 2016

### Handling Precautions

Although ESD protection circuitry has been designed into the VS-500 proper precautions should be taken when handling and mounting. VI employs a human body model and a charged-device model (CDM) for ESD susceptibility testing and design protection evaluation.

### ESD Ratings

Model	Minimum	Conditions
Human Body Model	1500 V	MIL-STD 883, Method 3015
Charged Device Model	1000 V	JESD 22-C101

### Recommended Solder Reflow Profile

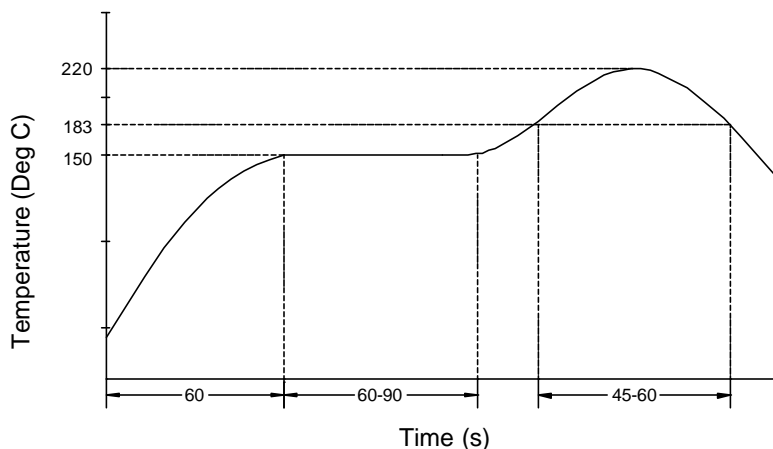

VI qualification includes aging at various extreme temperatures, shock and vibration, temperature cycling, and IR reflow simulation. The conditions a device can withstand are well understood and devices can be subjected to the profile above. This profile shows a ramp up condition to prevent thermal shock, a preheat period in which the flux is activated, a ramp up to 183°C which is the reflow temperature of Sn/Pb eutectic, and a gradual cool down. The time above 183°C should not exceed 60 seconds and the peak temperature should be no more than 220°C for 10 seconds. The VS-500's are hermetically sealed so an aqueous wash is not an issue.

# VS-500 Voltage Controlled SAW Oscillator

Standard Frequencies (MHz)					
155.5200	156.2500	159.3750	161.1328	164.3555	166.6286
167.3316	177.7371	311.0400	622.0800	624.7048	625.0000
627.3296	629.9878	644.5313	657.4219	666.5143	669.3266
669.6429	670.8386	672.1627	690.5692	693.4830	693.7500
716.5372	718.7500	719.7344	748.0709	750.0000	779.5686
781.2500	805.6641				

Other Frequencies Available Upon Request.

## Ordering Information

### VS - 500 - L F F - G N N - xxx.xxx

**Product Family**

VS: VCSO

**Frequency (See Above)**

155 – 850 MHz

**Package**

500: 9 x 14 x 4.5 mm

**Input**

L: 3.3 V

K: 5.0V<sup>1</sup>

**Other (Future Use)**

N: N/A

**Output**

E: ECL<sup>2</sup>

F: PECL

**Other (Future Use)**

N: N/A

**Operating Temperature**

F: -40 to 85 °C

**Absolute Pull Range**

G: +/- 50 ppm

H: +/- 100 ppm

<sup>1</sup>For all new 5.0V supply requirements, PECL output configuration is suggested. <sup>2</sup>ECL “E” Is Only Available In 5.0V “K” Configuration and is offered to make the Vc Input Impedance backward compatible with the VS-500A & VS-500F products. For further information, please contact your local Vectron Marketing Representative.

## Part Number Cross Reference

Old Part Number	New Part Number
VS-500A	VS-500-KEF-GNN
VS-500F	VS-500-KEF-HNN

## For Additional Information, Please Contact:



USA: Vectron International, 267 Lowell Rd, Hudson, NH 03051 . . . Tel: 1-88-VECTRON-1 Fax: 1-888-FAX-VECTRON  
 EUROPE: . . . . . Tel: +49 (0) 3328-4784-17 Fax: +49 (0) 3328-4784-30  
 ASIA: . . . . . Tel: +86-21-28909740 Fax: +86-21-28909999

Vectron International reserves the right to make changes to the product(s) and or information contained herein without notice. No liability is assumed as a result of their use or application. No rights under any patent accompany the sale of any such product(s) or information.