



Single-chip USB/PS2 optical mouse

Features

- Suitable for use with both LED and laser (VCSEL) light sources
- Single chip design with minimal support circuitry
- USB and PS2 operation
- Single +5 V supply
- No mechanical moving parts required
- 800 cpi resolution (400 cpi selectable)
- 9600 frames per second
- Tracking at up to 40 ips
- Up to 5 switch inputs and scroll wheel
- Possible customizing for VID, PID and descriptor string with external EEPROM
- Proven, high volume package technology

Description

The VT5363 optical tracking sensor is a complete solid state tracking engine with no moving parts. This single chip optical mouse sensor provides excellent control and precision and works on a wide range of surfaces.

The VT5363 supports 2, 3 or 5 button mouse designs with a mechanical scroll wheel encoder. It contains a dual USB/PS2 interface with automatic interface selection and may be powered directly from the USB or PS2 port. A single 6MHz resonator provides all the clock requirements and a minimum of additional passive components are required.

An external EEPROM may be used to implement customer specific USB configurations (PID, VID and descriptor string).

The VT5363 sensor operates over a wide range of illuminant wavelengths. For devices operating at approximately 850nm (IR LED or VCSEL), the on-die automatic exposure controller (AEC)

compensates for the change in sensitivity compared to 640nm (red LED). Motion performance can be improved by increasing the current supplied to the navigation LED.

A specifically designed optical system with integrated light guide and lens is available. This has been optimized for low cost, space saving and ease of mouse manufacture. No kapton tape is required in the assembly process.

Applications

- Optical USB/PS2 mouse for desktop PC, workstation and laptop

Technical specifications

Resolution	800 CPI (400 selectable)
Pixel size	30.4 μm
Array size	20*20 pixels
Frame rate	9600 frames/second
High Speed Motion Detector	Accurate motion up to 40 ips
Clock	6 MHz resonator
Supply voltage	5 V direct from USB or PS2 port
Supply current	15mA (typ.) (excludes LED)
Operating temperature	[0: 60] °C
Package type	7*7mm 32 lead LOQFP ⁽¹⁾

1. LOQFP: Low profile Optical Quad Flat Pack

Contents

- 1 Introduction 4**
- 2 Design notes 5**
 - 2.1 Pin assignment 5
 - 2.2 Pin description 6
 - 2.3 Reference schematic 7
 - 2.4 Bill of materials - BOM 8
 - 2.5 Switches 8
 - 2.6 Scroll wheel 8
 - 2.7 Driving the navigation LED 9
 - 2.8 LNK_LED output 9
 - 2.9 Optical centre 9
 - 2.10 Sensor orientation on PCB 10
- 3 Configuring the VT5363 11**
 - 3.1 Selecting USB or PS2 operation 11
 - 3.2 Selecting mouse configuration 11
 - 3.3 Changing the CPI 11
 - 3.4 External EEPROM 11
 - 3.5 EEPROM data format 12
 - 3.6 Application support 13
- 4 Optics assembly 14**
 - Mouse assembly guidelines 16
- 5 LED selection 17**
 - 5.1 Overview 17
 - 5.2 Key LED parameters 17
 - 5.3 VCSEL and IR illumination 17
- 6 Electrical characteristics 18**
- 7 Typical performance characteristics 19**

8	Package information	20
	8.1 Package mechanical data	20
	8.2 LOQFP package guidelines	21
9	Ordering information	22
10	Revision history	22

1 Introduction

The VT5363 sensor is a single-chip solid state optical tracking engine with no moving parts. It allows the creation of a high performance, fully featured mouse with the minimum of external components. The device provides excellent navigation control and precision and works on a wide range of surfaces.

VT5363 incorporates features that simplify product design and reduce time to market. By minimizing the number of external components, the mouse manufacturer has flexibility for layout and product design.

ST has worked with optical component suppliers to produce a single piece light guide with integrated lens, and recommendations for a compatible LED. Details of the optics and LED are included in this datasheet. The main functional blocks of the VT5363 are shown in [Figure 1](#).

Figure 1. VT5363 block diagram

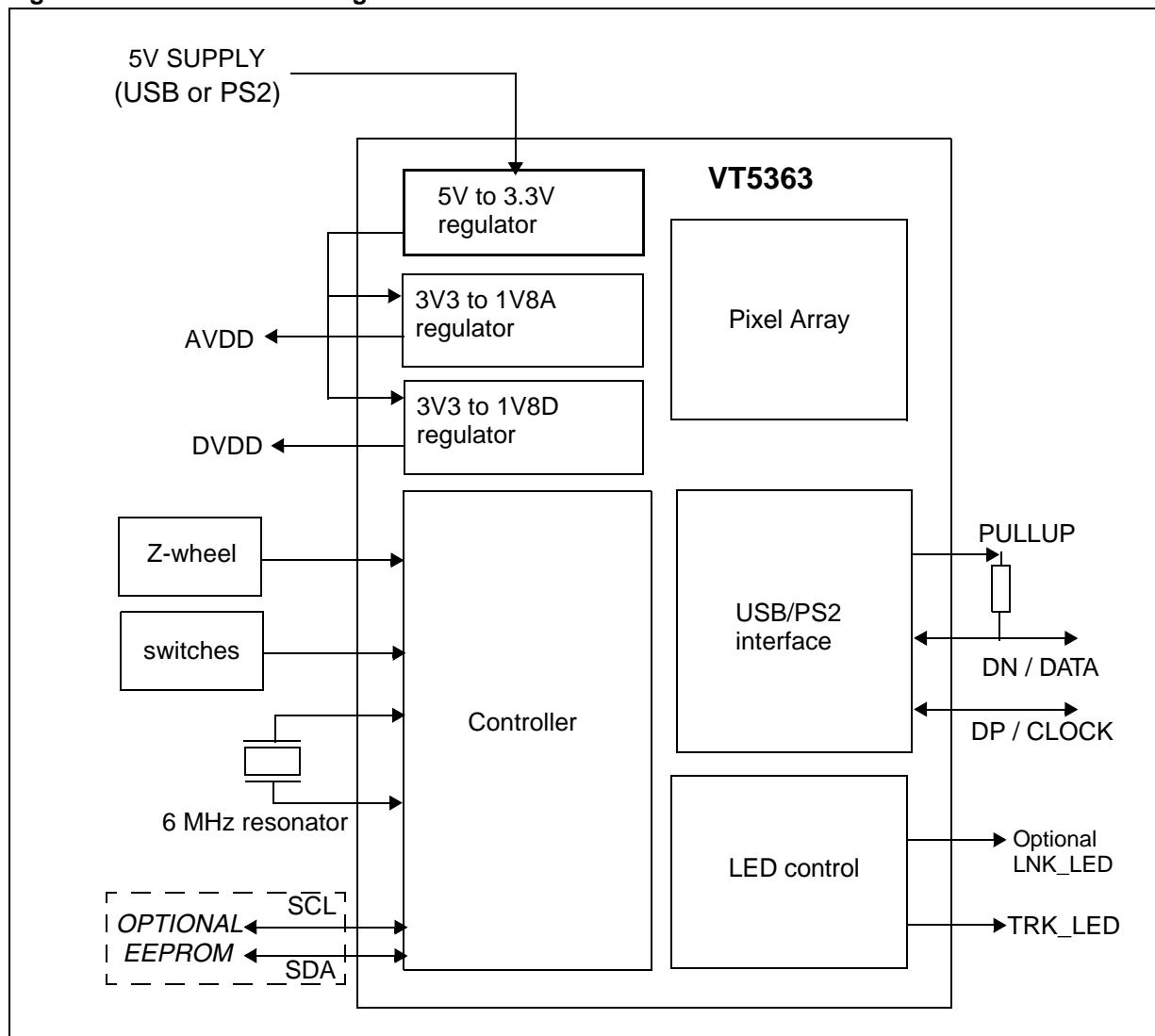

2 Design notes

2.1 Pin assignment

Figure 2. VT5363 pin assignment

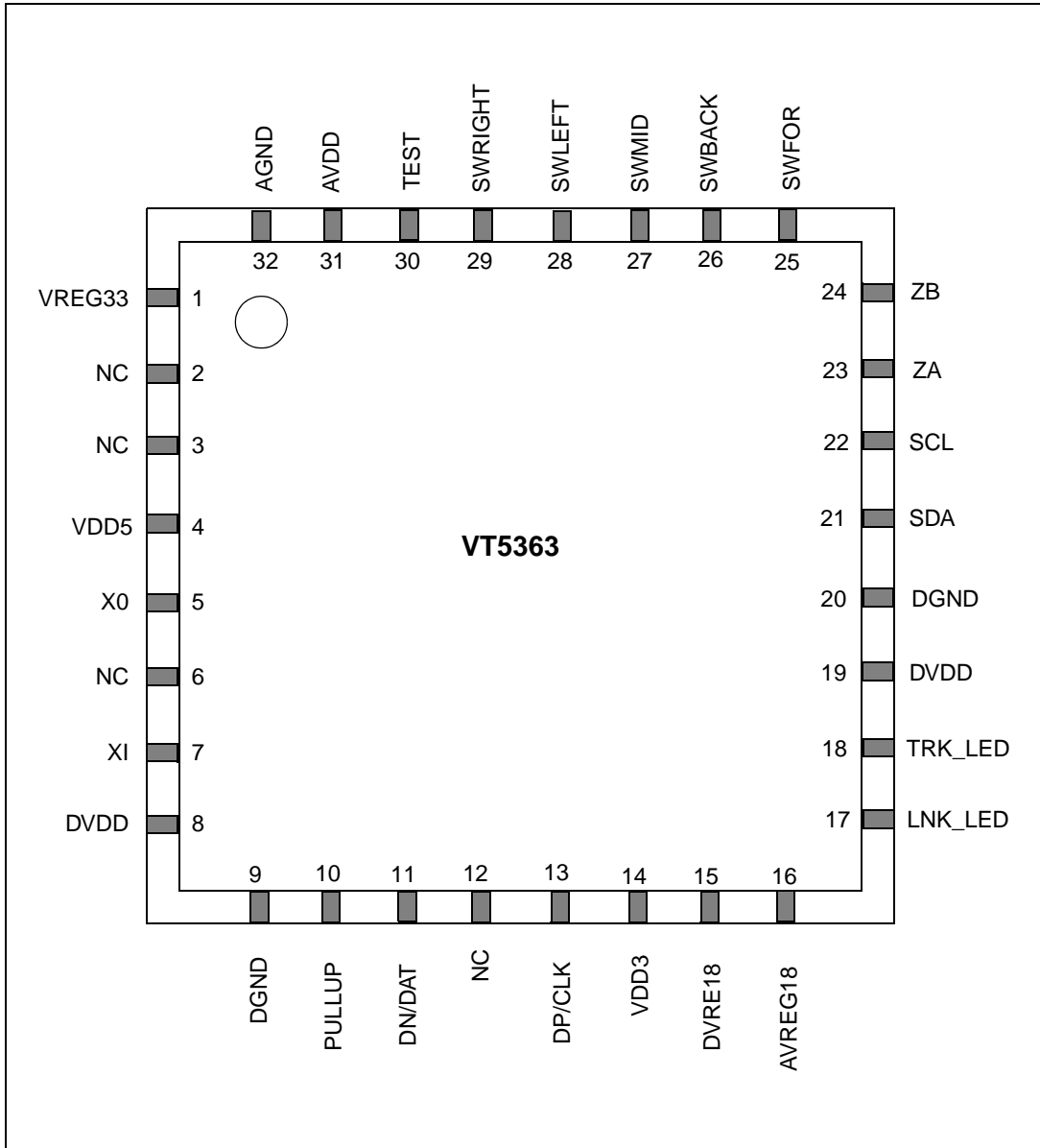

2.2 Pin description

Table 1. VT5363 pin description

Pin N°	Pin name	Type	Comment
1	VREG33	PWR	3.3 V regulator output
4	VDD5	PWR	5V supply - direct from USB or PS2 supply
5	X0	OSC	6MHz resonator
7	XI	OSC	6MHz resonator
8	DVDD	PWR	1.8V digital supply
9	DGND	PWR	Digital ground
10	PULLUP	I/O	connect 1K5 resistor from here to DN/DAT
11	DN / DAT	I/O	DN in USB mode, DATA in PS2 mode
13	DP/ CLK	I/O	DP in USB mode, CLOCK in PS2 mode
14	VDD3	PWR	3.3V supply
15	DVREG18	PWR	1.8V digital regulator output - use to drive DVDD
16	AVREG18	PWR	1.8V analogue regulator output - use to drive AVDD
17	LNK_LED	O	Status LED output
18	TRK_LED	O	Navigation LED output
19	DVDD	PWR	1.8V digital supply
20	DGND	PWR	Digital ground
21	SDA	I/O	I2C SDA line
22	SCL	I/O	I2C SCL line
23	ZA	I/O	Z-wheel input A
24	ZB	I/O	Z-wheel input B
25	SWFOR	I/O	'Forward' switch input (active low)
26	SWBACK	I/O	'Back' switch input (active low)
27	SWMID	I/O	'Middle' switch input (active low)
28	SWLEFT	I/O	'Left' switch input (active low)
29	SWRIGHT	I/O	'Right' switch input (active low)
30	RESERVED	I	Connect to GROUND
31	AVDD	PWR	1.8 V analogue supply
32	AGND	PWR	Analogue ground

Note: All other pins are NOT CONNECTED

2.3 Reference schematic

Figure 3. VT5363 reference schematic

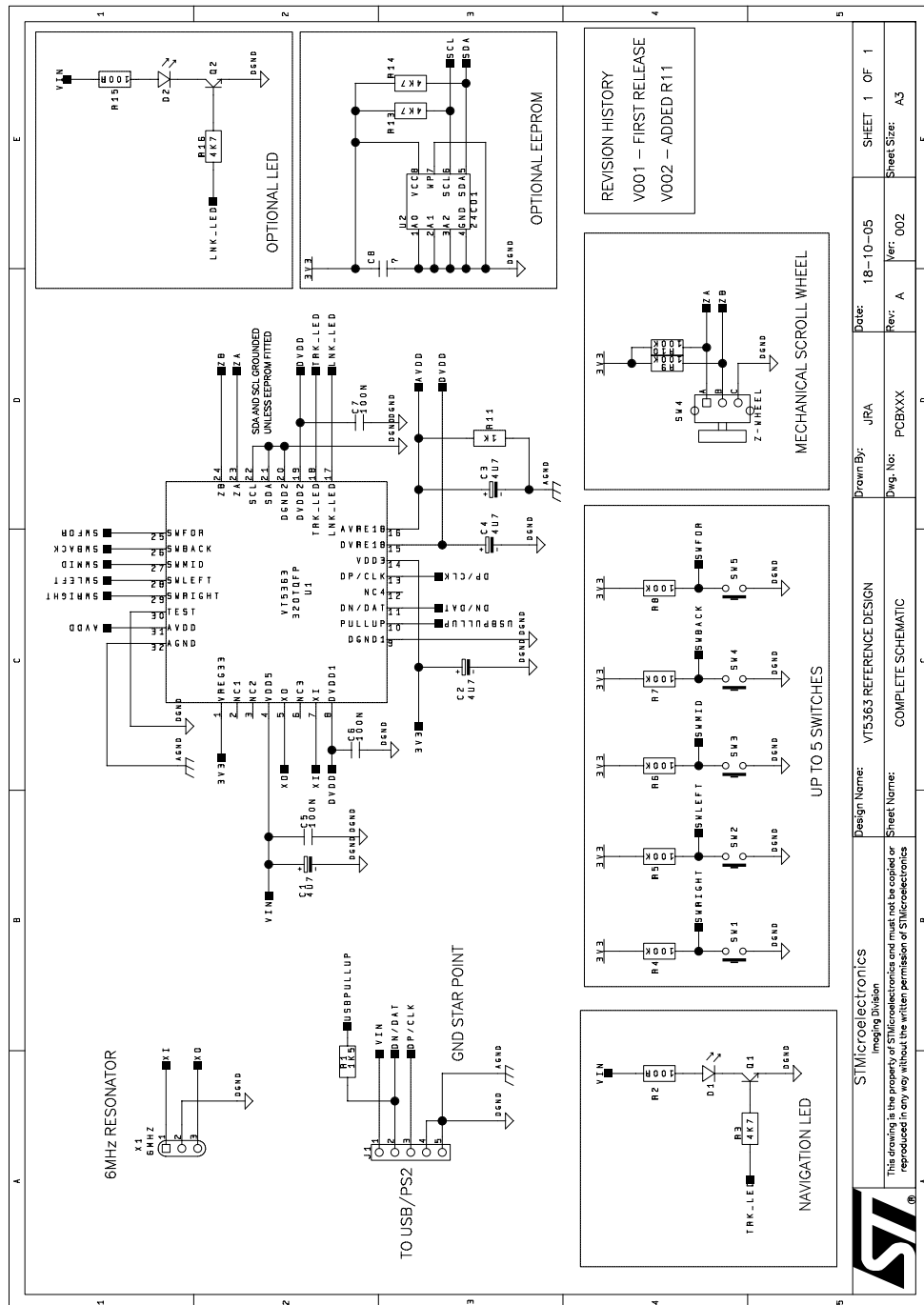

STMicroelectronics
Imaging Division
This drawing is the property of STMicroelectronics and must not be copied or reproduced in any way without the written permission of STMicroelectronics

Design Name: VT5363 REFERENCE DESIGN
Sheet Name: COMPLETE SCHEMATIC

Drawn By: JRA
Date: 18-10-05
Dwg. No: PCBXXX
Rev: A
Ver: 002
SHEET 1 OF 1
Sheet Size: A3

2.4 Bill of materials - BOM

Table 2. Bill of materials: main components

Ref.	Description	Manufacturer	Part number
U1	Optical mouse sensor	STMicroelectronics	VT5363V032
X1	6MHz resonator	Murata	CSTLA6M00G55-B0
D1	Navigation LED	See Chapter 5: LED selection	
SW1-4	Switches	Omron	D2F series
SW5	Mechanical encoder (scroll-wheel)	Alps	EC10E series
Q1	NPN bipolar transistor (to drive D1)	Standard component - many suppliers	
C1-C4	4u7 tantalum capacitor	Standard component - many suppliers	
C5-C7	100nF ceramic capacitor	Standard component - many suppliers	
R1	1k5 resistor	Standard component - many suppliers	
R4-R10	100k resistors	Standard component - many suppliers	
R11	1k resistor	Standard component - many suppliers	
Only required if EEPROM is fitted			
U2	EEPROM	STMicroelectronics	M24C01W
R13,R14	10k resistors	standard component - many suppliers	
Additional items not mounted on the PCB			
	Optics Assembly	See STV-363-R01 Reference Design Manual	
	Aperture Stop	See STV-363-R01 Reference Design Manual	
	USB/PS2 cable	Standard component - many suppliers	

2.5 Switches

The VT5363 supports up to 5 switch inputs. These switches provide the standard mouse functions of LEFT, RIGHT and MIDDLE as well as the advanced functions of BACK and FORWARD. The switch inputs are all active LOW. An external pull-up resistor is required between the switch input and the 3V3 supply.

2.6 Scroll wheel

The VT5363 supports the use of an external mechanical shaft encoder with quadrature outputs to act as a scroll wheel. The EC10E series from Alps are suitable. Pull-up resistors are required between the ZA and ZB outputs of the shaft encoder and the 3V3 supply. Note that the two quadrature outputs ZA and ZB are not interchangeable and must be connected correctly.

2.7 Driving the navigation LED

The VT5363 provides an output (NAV_LED) for driving the LED used to illuminate the mousing surface. This output is active HIGH but cannot be used to drive the navigation LED directly. An external NPN bipolar transistor is recommended as shown in the reference schematic. The maximum current through the LED is controlled by a resistor (R1 on the Reference Schematic).

2.8 LNK_LED output

The VT5363 has an output (LNK_LED) which is high whenever the mouse is active (i.e. connected to a PC which is not in a suspend state).

The user does not need to use this output to produce a working mouse but it may be used to drive an additional LED for cosmetic purposes. An external bipolar transistor is required in the same way as the navigation LED.

2.9 Optical centre

The optical centre of the VT5363 is NOT in the centre of the package, it is offset by -0.243mm in the X-axis and 0.215mm in the Y axis with respect to the centre of the package as shown below. The PCB designer must take this into account when laying out the PCB.

Figure 4. VT5363 optical centre

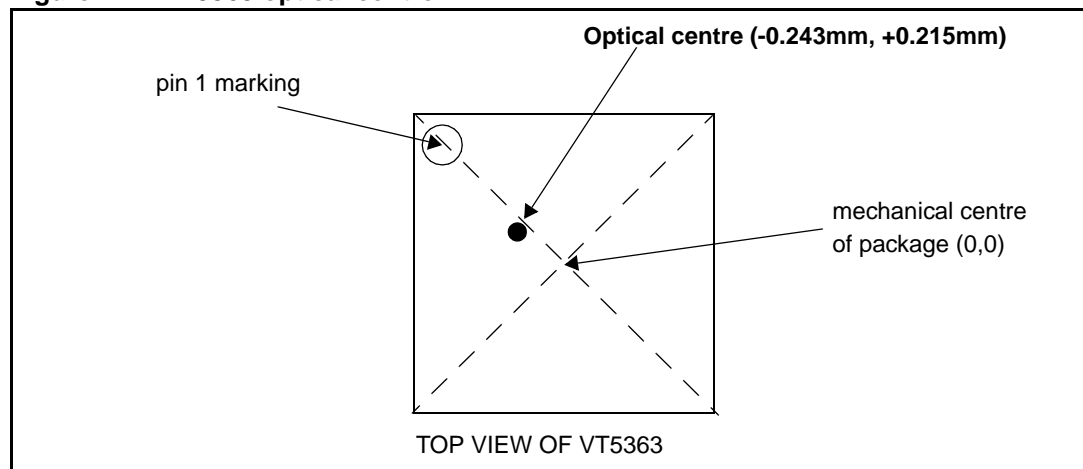

2.10 Sensor orientation on PCB

The VT5363 must be orientated correctly on the PCB in order to move the cursor in the correct directions when the mouse is moved. This is shown in [Figure 5](#).

Figure 5. VT5363 orientation

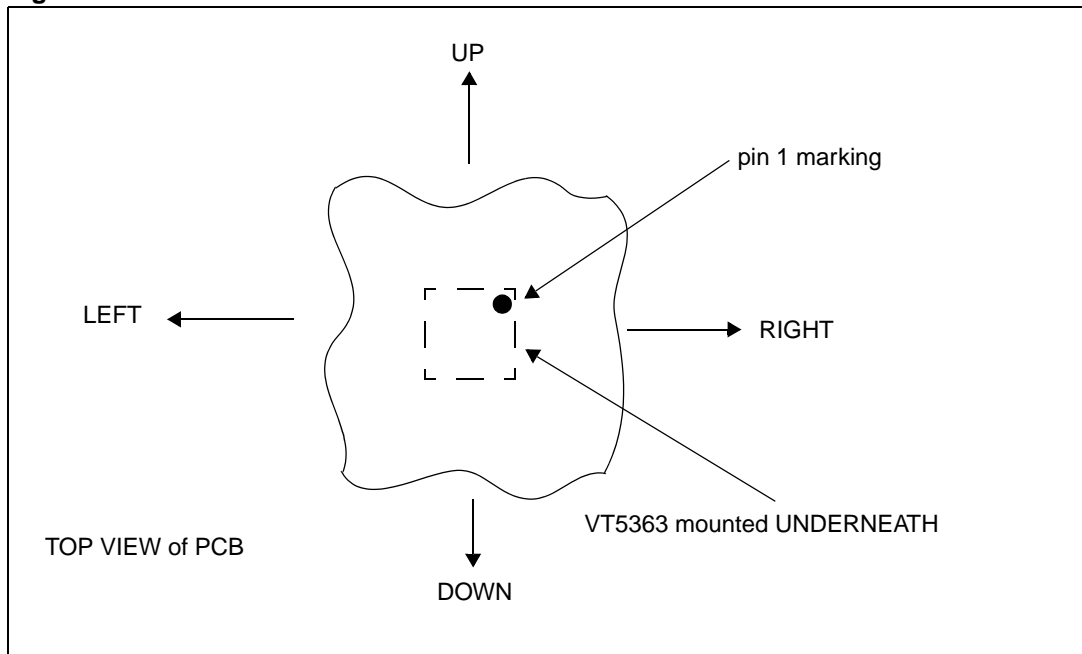

3 Configuring the VT5363

3.1 Selecting USB or PS2 operation

The selection of USB or PS2 interface is performed [automatically] by the VT5363 including a USB pull-up resistor connected between Pin No. 10 and the DN/DAT line.

3.2 Selecting mouse configuration

The VT5363 may be configured to be one of three different types of mouse.

- 2 button mouse
- 3 button mouse with scroll wheel
- 5 button mouse with scroll wheel

The configuration is achieved by connecting the unused switch inputs to the LNK_LED output (pin 17). All configurations will report a USB Vendor Identity (VID) of 0x0553 (ST Microelectronics Imaging Division). The three different configurations will result in 3 different USB Product Identities (PIDs) and descriptor strings as described in [Table 3](#).

Table 3. Configuration selection

Mode	Inputs tied to LNK_LED	VID	PID	USB descriptor string
2 button	SWBACK, SWFOR, SWMID	0x0553	0x0A00	'2 button optical mouse'
3 button + Z	SWBACK, SWFOR	0x0553	0x0A01	'3 button optical mouse with scroll wheel'
5 button + Z	none	0x0553	0x0A02	'5 button optical mouse with scroll wheel'

A user who wishes to use their own PID, VID and descriptor string may use an external serial EEPROM to hold this information.

3.3 Changing the CPI

The default CPI 'Counts Per Inch' of the VT5363 is 800CPI, this can easily be toggled between 800/400CPI by the user, by simply holding down the left and right buttons till LNK_LED goes off. If the PC is shutdown or the mouse unplugged it will return to the default (800 CPI).

3.4 External EEPROM

The VT5363 supports the use of an external 128 byte serial EEPROM for holding customer specific information. EEPROM such as the M24C01W from STMicroelectronics are suitable. The EEPROM must be connected to the SDA and SCL pins of the VT5363. If no EEPROM is used then these lines should be tied to ground. The EEPROM cannot be programmed by the VT5363 itself and must be pre-programmed before being fitted to the final PCB.

3.5 EEPROM data format

A 128 byte serial EEPROM is used to hold USB configuration information. The lower 64 bytes hold USB PID, VID and string information as shown in the table below. The upper bytes may be used to hold special setup information, for example to set the resolution to 400cpi (contact STMicroelectronics for details).

Location 127 in the EEPROM must hold the number 0xAA and is used to detect that an EEPROM has been fitted. If location 127 does not contain 0xAA the EEPROM contents will be ignored.

Table 4. Example EEPROM contents

EEPROM Location	Contains	Notes
0	VID (LSB)	Vendor ID (only one VID is stored for all 3 mouse configurations)
1	VID (MSB)	
2	PID (LSB)	Product ID for 2 button mouse
3	PID (MSB)	
4	PID (LSB)	Product ID for '3 button + Z' mouse
5	PID (MSB)	
6	PID (LSB)	Product ID for '5 button + Z' mouse
7	PID (MSB)	
8	0x04	Language ID Length
9	0x03	Language ID Type
10	0x09	Language ID (2 bytes)
11	0x04	(0x0904 = US English)
12	0x0C	String ID Length = (number of characters in string *2) + 2 For the example string 'MOUSE' this is (2*5)+2 = 12 = 0x0C
13	0x03	String ID Type
14	0x4D	ASCII code for first character of String (example for 'M')
15	0x4F	ASCII code for first character of String (example for 'O')
16	0x55	ASCII code for first character of String (example for 'U')
17	0x53	ASCII code for first character of String (example for 'S')
18	0x45	ASCII code for first character of String (example for 'E')
19 - 62	0xFF	Rest of lower half of EEPROM is available for longer strings, up to 50 characters maximum (set unused locations to 0xFF)
64-126	0xFF	Leave upper half of EEPROM empty (may be used to hold special setup information - contact STMicroelectronics for details)
127	0xAA	Special flag to indicate that EEPROM is present

3.6 Application support

The user manual for the STV-363-R01 reference design board includes additional information and application support.

Figure 6. STV-363-R01 - USB/PS2 mouse reference design board



4 Optics assembly

The optics assembly is shown in *Figure 7* and *Figure 8*.

Figure 7. MaxEmil optics

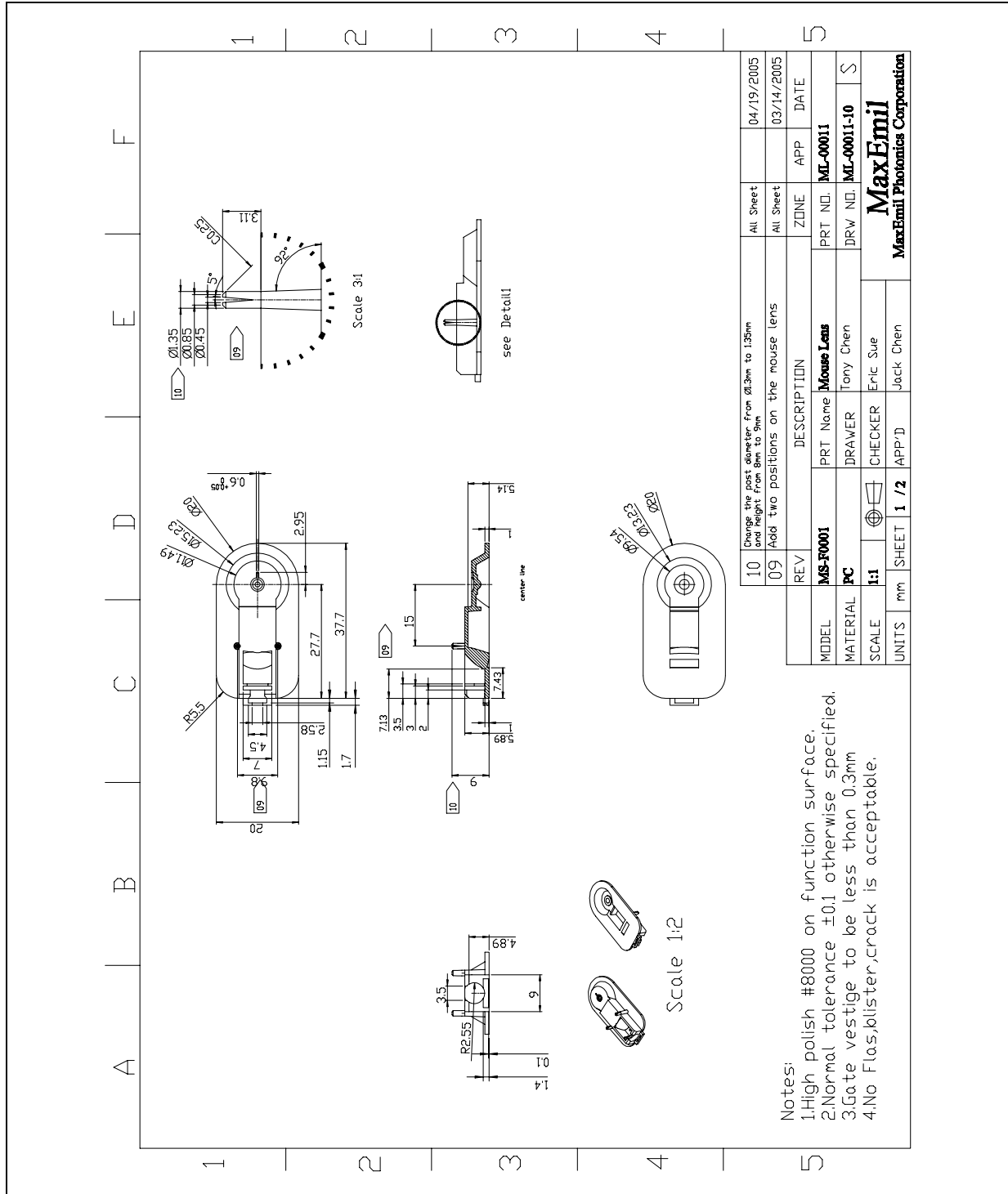
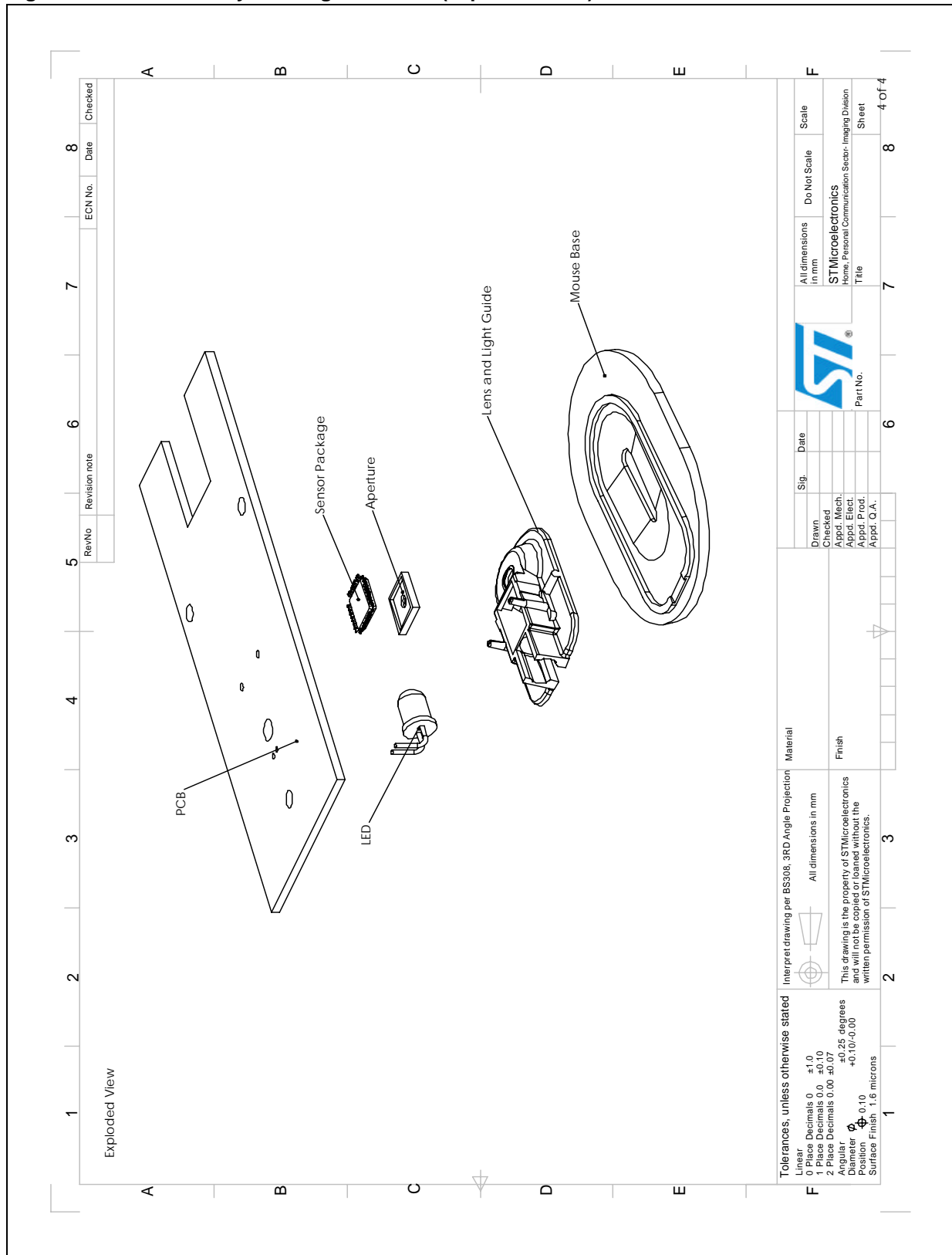

Figure 8. 2D assembly drawing of VT5363 (exploded view)



Mouse assembly guidelines

1. Attach the sensor and all other electrical components onto PCB with the exception of the navigation LED.
2. Form the LED leads and insert the LED into the optical assembly.
3. Fit the optics with aperture to the PCB using the guideposts and feed the navigation LED leads through their openings. Take care to keep contamination off the sensor surface. The aperture should self-align to the VT5363 package.
4. Route the USB/PS2 lead through the base plate then fit the base plate.
5. Solder the navigation LED leads and trim.
6. Add mouse top case and feet.

Note: For more details on the optics (including manufacturers), please refer to the STV-363-R01 user manual.

5 LED selection

5.1 Overview

There are a number of LEDs from a range of suppliers which will work well with the VT5363. It is the responsibility of the customer to ensure that the chosen LED works in their specific implementation. There are various price/performance trade-offs which may be made if the customer chooses to do so.

5.2 Key LED parameters

The VT5363 system requires a bright visible RED LED in a standard 5mm (T1 3/4) package. The ideal viewing angle is 20° and the intensity should be at least 900mcd at a forward current of 20 mA. The key LED parameters are listed in [Table 5](#).

Table 5. Key LED parameters

Parameter	Recommended Value	Notes
Diameter	5mm	Important for fit with lens
Length	8.6mm	Important for fit with lens
Material	AllnGaP	For long-term reliability
Luminous Intensity (@20mA)	900mcd	Minimum value
Viewing Angle	20°	Half intensity
Mechanical accuracy	+/- 2°	Accuracy of the die positioning within the LED body
Color	Red	
Wavelength	640nm +/- 50nm	
Relative illumination at sensor plane for a circle of 1.1 mm diameter	80%	Illumination value required for Red/IR LED and VCSEL

5.3 VCSEL and IR illumination

The VT5363 sensor will operate over a wide range of illuminant wavelengths. For devices operating at approximately 850 nm (IR LED or VCSEL), the on-die automatic exposure controller (AEC) will compensate for the change in sensitivity compared to 640nm (red LED). Navigation performance may be improved by increasing the illuminated device drive. approx.

6 Electrical characteristics

Table 6. Typical operating conditions

Symbol	Parameter	Min.	Typ.	Max.	Unit
V _{in}	Supply voltage	4.1	5	5.6	V
	Supply current (active)		17	23.3	mA
	Supply current (suspend)		45	100	μA

7 Typical performance characteristics

Figure 9 shows the typical performance of the VT5363 sensor.

Figure 9. Typical resolution versus height

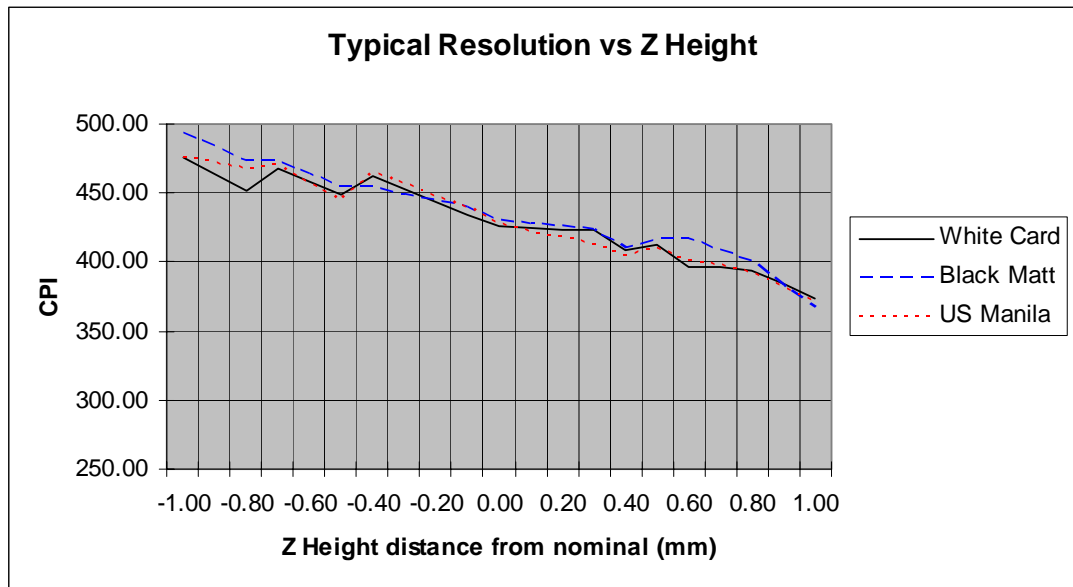

Note: Z = distance from lens to surface

8 Package information

8.1 Package mechanical data

Figure 10. LQFP32 clear resin body 7.0 x 7.0 x 1.40 foot print 1.0

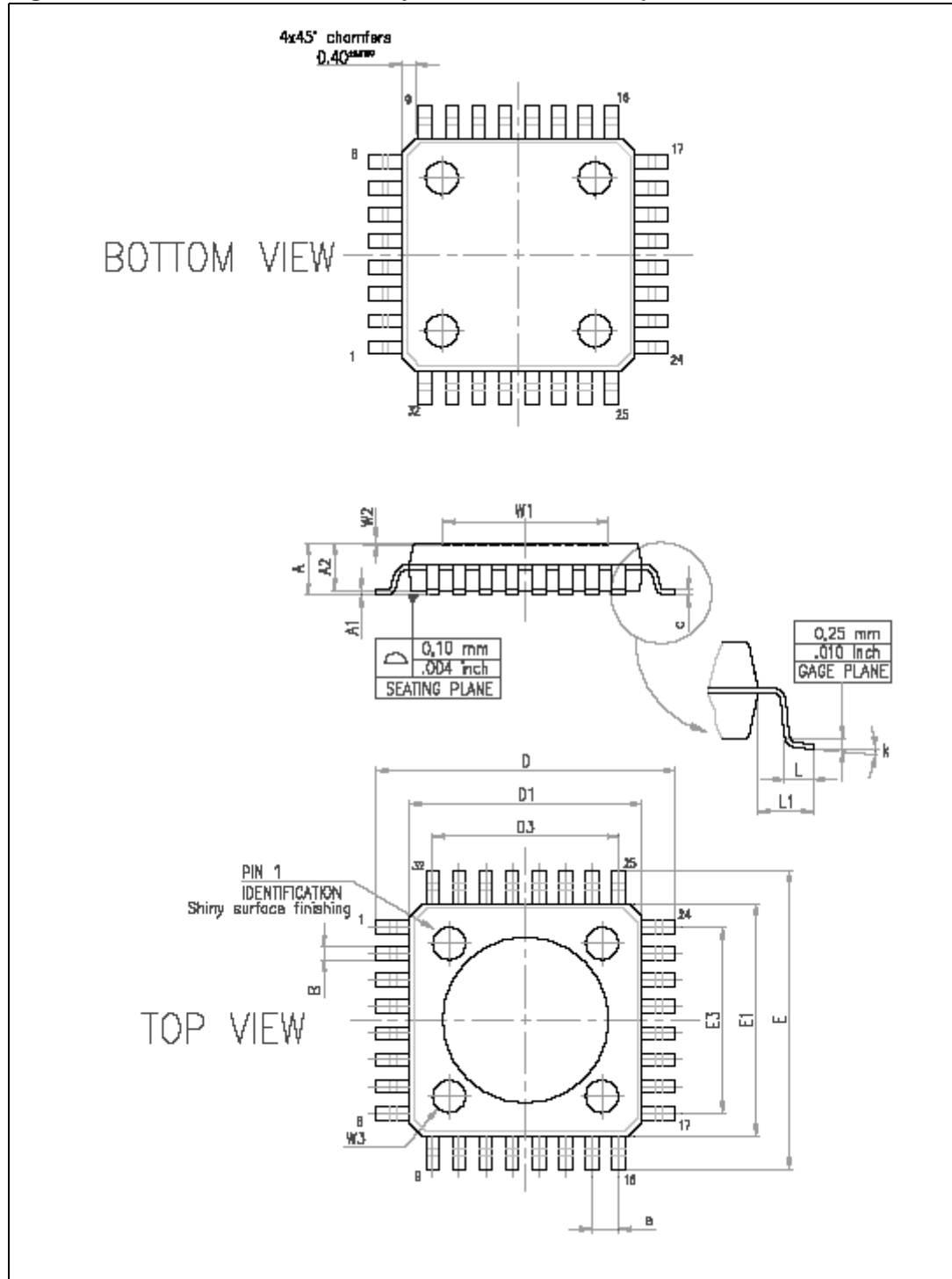

Table 7. LQFP dimensions (mm)

Reference	Min. (mm)	Typ. (mm)	Max. (mm)
A			1.600
A1	0.050		0.15
A2	1.350	1.400	1.450
B	0.300	0.370	0.450
c	0.090		0.200
D		9.00	
D1		7.000	
D3		5.600	
e		0.800	
E		9.000	
E1		7.000	
E3		5.600	
L	0.450	0.600	0.750
L1		1.000	
k	0d	3.5d	7d
W1		5.000	
W2		0.065	

- Note:
- 1 Surface finish W1 is 0.07 Ra.
 - 2 Ejectors are on 5.2 mm square for both top and bottom package.
 - 3 On top package, only the identification for pin one is not an engraved ejector.

8.2 LOQFP package guidelines

The IC can be exposed a maximum of 2 times to an IR/Convection reflow solder process having a temperature profile peak of no higher than 240°C.

The package/chip are lead free and is ROHS compliant.

9 Ordering information

Table 8: Order codes

Part Number	Description
VT5363V032	USB/PS2 optical mouse sensor

10 Revision history

Table 9. Document revision history

Date	Revision	Changes
13-Feb-2006	1	Initial release.
18-Apr-2006	2	Updates in the document format. No changes in the content.
19-Dec-2006	3	Added suitability for use with both LED and laser light sources on cover page (features and description). Section 5.2: Key LED parameters - Added 'Relative illumination' parameter in Table 5: Key LED parameters . Replaced Figure 7: MaxEmil optics . Move the order codes to Chapter 9 .
24-Jan-2007	4	Changed the document status to datasheet.

Please Read Carefully:

Information in this document is provided solely in connection with ST products. STMicroelectronics NV and its subsidiaries ("ST") reserve the right to make changes, corrections, modifications or improvements, to this document, and the products and services described herein at any time, without notice.

All ST products are sold pursuant to ST's terms and conditions of sale.

Purchasers are solely responsible for the choice, selection and use of the ST products and services described herein, and ST assumes no liability whatsoever relating to the choice, selection or use of the ST products and services described herein.

No license, express or implied, by estoppel or otherwise, to any intellectual property rights is granted under this document. If any part of this document refers to any third party products or services it shall not be deemed a license grant by ST for the use of such third party products or services, or any intellectual property contained therein or considered as a warranty covering the use in any manner whatsoever of such third party products or services or any intellectual property contained therein.

UNLESS OTHERWISE SET FORTH IN ST'S TERMS AND CONDITIONS OF SALE ST DISCLAIMS ANY EXPRESS OR IMPLIED WARRANTY WITH RESPECT TO THE USE AND/OR SALE OF ST PRODUCTS INCLUDING WITHOUT LIMITATION IMPLIED WARRANTIES OF MERCHANTABILITY, FITNESS FOR A PARTICULAR PURPOSE (AND THEIR EQUIVALENTS UNDER THE LAWS OF ANY JURISDICTION), OR INFRINGEMENT OF ANY PATENT, COPYRIGHT OR OTHER INTELLECTUAL PROPERTY RIGHT.

UNLESS EXPRESSLY APPROVED IN WRITING BY AN AUTHORIZED ST REPRESENTATIVE, ST PRODUCTS ARE NOT RECOMMENDED, AUTHORIZED OR WARRANTED FOR USE IN MILITARY, AIR CRAFT, SPACE, LIFE SAVING, OR LIFE SUSTAINING APPLICATIONS, NOR IN PRODUCTS OR SYSTEMS WHERE FAILURE OR MALFUNCTION MAY RESULT IN PERSONAL INJURY, DEATH, OR SEVERE PROPERTY OR ENVIRONMENTAL DAMAGE. ST PRODUCTS WHICH ARE NOT SPECIFIED AS "AUTOMOTIVE GRADE" MAY ONLY BE USED IN AUTOMOTIVE APPLICATIONS AT USER'S OWN RISK.

Resale of ST products with provisions different from the statements and/or technical features set forth in this document shall immediately void any warranty granted by ST for the ST product or service described herein and shall not create or extend in any manner whatsoever, any liability of ST.

ST and the ST logo are trademarks or registered trademarks of ST in various countries.

Information in this document supersedes and replaces all information previously supplied.

The ST logo is a registered trademark of STMicroelectronics. All other names are the property of their respective owners.

© 2007 STMicroelectronics - All rights reserved

STMicroelectronics group of companies

Australia - Belgium - Brazil - Canada - China - Czech Republic - Finland - France - Germany - Hong Kong - India - Israel - Italy - Japan - Malaysia - Malta - Morocco - Singapore - Spain - Sweden - Switzerland - United Kingdom - United States of America

www.st.com