

Conformal, Single In-Line Resistor Networks (Standard)

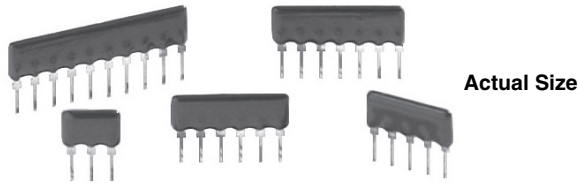

VISHAY Thin Film resistor networks are designed to be used in analog circuits in conjunction with operational amplifiers. Engineers can use these circuits to achieve an infinite number of very low noise and high stability circuits for industrial, medical and scientific instrumentation.

This family of standard resistor networks will continually be expanded with new and innovative designs, and VISHAY Thin Film stocks most designs in house for off-the-shelf convenience. However, if you can not find the standard network you need, call Applications Engineering at (716) 283-4025, as we may be able to meet your requirements with a semicustom "match" for a quick delivery.

For standard networks with tighter specifications, or for custom networks, contact Applications Engineering at the above number. For a quick review of typical applications, request VISHAY's Guide to Understanding and Using Thin Film Precision Networks.

FEATURES

- Lead (Pb)-free available
- Off-the-shelf delivery
- Wide variety of standards
- Small size (SIP)
- Standard designs - no NRE
- Low capacitance < 0.1 pF/PIN
- Flame resistant (UL94V-0 rating)



TYPICAL PERFORMANCE

	ABS	TRACKING
TCR	10	2
	ABS	RATIO
TOL	0.1	0.02

Complete Electrical Specifications at the end of schematics.

THROUGH HOLE NETWORKS

SCHEMATIC

R1 = R2

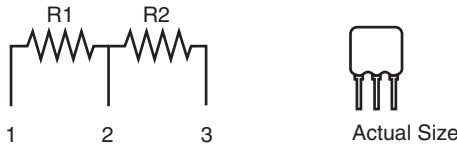

L = Total Length = 0.320" (8.13 mm) Max.
 H = Seated Height = 0.280" (7.11 mm) Max.
 Except PN 218 where Seated Height = 0.342" (8.69 mm) Max.

TWO EQUAL RESISTORS

ORDERING INFORMATION

R1 = 1K: VTF209BX	50K: VTF214BX
2K: VTF210BX	100K: VTF215BX
5K: VTF211BX	200K: VTF216BX
10K: VTF212BX	500K: VTF217BX
20K: VTF213BX	1M: VTF218BX

Lead (Pb)-free option add "S" after part number, e.g: VTF209SBX

R1 + R2 = 10K, 100K, 1M

$$\frac{R1 + R2}{R2} = 10$$

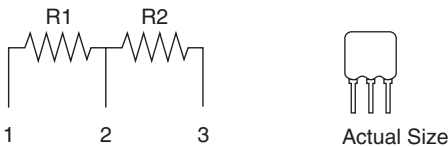

L = Total Length = 0.320" (8.13 mm) Max.
 H = Seated Height = 0.280" (7.11 mm) Max.
 Except PN 281 where Seated Height = 0.362" (9.19 mm) Max.

RATIO DIVIDER 10:1

ORDERING INFORMATION

R1 + R2 =
9K + 1K = 10K: VTF280BX
90K + 10K = 100K: VTF193BX
900K + 100K = 1M: VTF281BX

Lead (Pb)-free option add "S" after part number, e.g: VTF280SBX

* Pb containing terminations are not RoHS compliant, exemptions may apply



$R1 = 100K, 1M$

$\frac{R1}{R2} = 10$

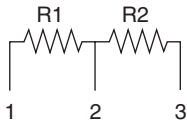

Actual Size

L = Total Length = 0.320" (8.13 mm) Max.
 H = Seated Height = 0.280" (7.11 mm) Max.
 Except PN 283 where Seated Height = 0.362" (9.19 mm) Max.

DIVIDER NETWORK 10:1

ORDERING INFORMATION

R1 = 100K: VTF282BX

R1 = 1M: VTF283BX

$R1 = R2$

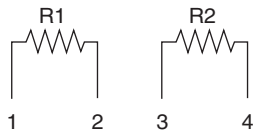

Actual Size

L = Total Length = 0.420" (10.67 mm) Max.
 H = Seated Height = 0.280" (7.11 mm) Max.

TWO EQUAL RESISTORS - ISOLATED

ORDERING INFORMATION

R1 = 1K: VTF365BX	50K: VTF1000BX
2K: VTF997BX	100K: VTF348BX
5K: VTF998BX	200K: VTF1105BX
10K: VTF363BX	500K: VTF1106BX
20K: VTF1104BX	1M: VTF1103BX
25K: VTF999BX	

Lead (Pb)-free option add "S" after part number, e.g: VTF365SBX

$R1 + R2 + R3 = 100K$

$\frac{R1 + R2 + R3}{R3} = 100$

$\frac{R1 + R2 + R3}{R2 + R3} = 10$

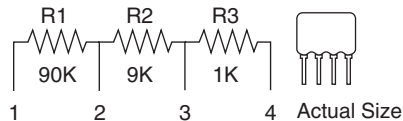

Actual Size

L = Total Length = 0.420" (10.67 mm) Max.
 H = Seated Height = 0.280" (7.11 mm) Max.

RATIO DIVIDER 10:1 AND 100:1

ORDERING INFORMATION

R1 + R2 + R3 = 100K: VTF330BX

Lead (Pb)-free option add "S" after part number, e.g: VTF330SBX

$R1 = R2 = R3 = R4 = 10K, 100K$

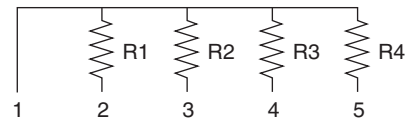

Actual Size

L = Total Length = 0.520" (13.21 mm) Max.
 H = Seated Height = 0.280" (7.11 mm) Max.

FOUR EQUAL RESISTORS ONE COMMON

ORDERING INFORMATION

R1 = 10K: VTF366BX

100K: VTF367BX

Lead (Pb)-free option add "S" after part number, e.g: VTF366SBX

$R1 = 10K$

$\frac{R2}{R1} = 1$

$R3 = \frac{R1 \times R2}{R1 + R2}$

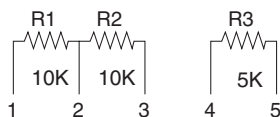

Actual Size

L = 0.520 (13.21 mm), H = 0.280 (7.11 mm) Max.

DIVIDER NETWORK 2:1

ORDERING INFORMATION

VTF1087BX

Lead (Pb)-free option add "S" after part number, e.g: VTF1087SBX

VTF (Standard)

Vishay Thin Film Conformal, Single In-Line Resistor Networks (Standard)

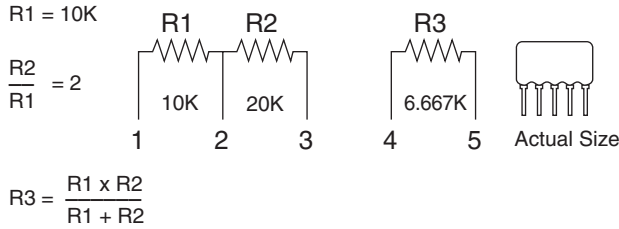

L = 0.520" (13.21 mm), H = 0.280" (7.11 mm) Max.

DIVIDER NETWORK 2:1

ORDERING INFORMATION

VTF1088BX

Lead (Pb)-free option add "S" after part number, e.g: VTF1088SBX

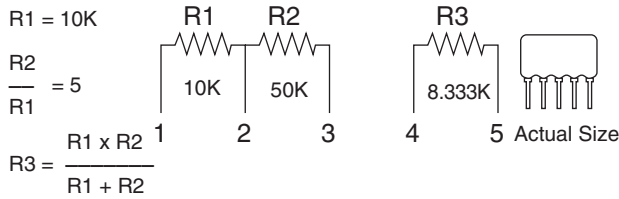

L = 0.520" (13.21 mm), H = 0.280" (7.11 mm) Max.

DIVIDER NETWORK 5:1

ORDERING INFORMATION

VTF1089BX

Lead (Pb)-free option add "S" after part number, e.g: VTF1089SBX

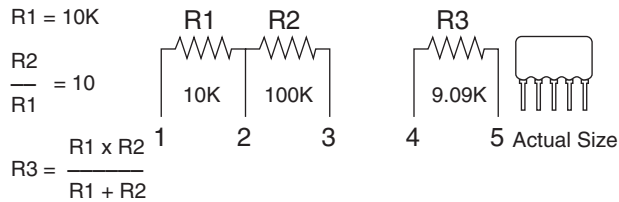

NOTE: R2 TC Tracking 3 ppm/°C

L = 0.520" (13.21 mm), H = 0.280" (7.11 mm) Max.

DIVIDER NETWORK 10:1

ORDERING INFORMATION

VTF1090BX

Lead (Pb)-free option add "S" after part number, e.g: VTF1090SBX

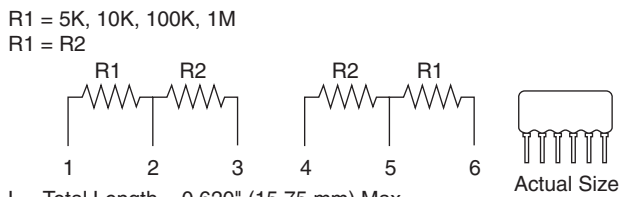

L = Total Length = 0.620" (15.75 mm) Max.

H = Seated Height = 0.280" (7.11 mm) Max.

Except PN 287 Seated Height = 0.362" (9.19 mm) Max.

DIVIDER NETWORK 1:1

ORDERING INFORMATION

R1 = 5K: VTF225BX

10K: VTF286BX

100K: VTF219BX

1M: VTF287BX

Lead (Pb)-free option add "S" after part number, e.g: VTF225SBX

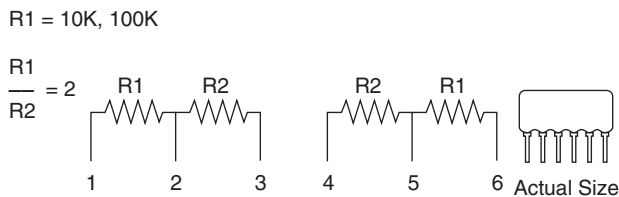

L = Total Length = 0.620" (15.75 mm) Max.

H = Seated Height = 0.280" (7.11 mm) Max.

DIVIDER NETWORK 2:1

ORDERING INFORMATION

R1 = 10K: VTF1009BX

100K: VTF1010BX

Lead (Pb)-free option add "S" after part number, e.g: VTF1009SBX



R1 = 10K, 100K

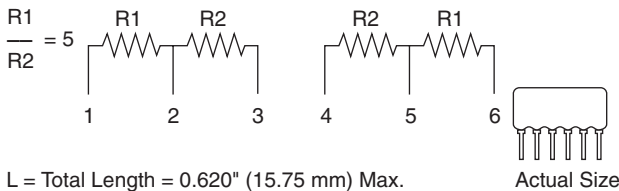

L = Total Length = 0.620" (15.75 mm) Max.
H = Seated Height = 0.280" (7.11 mm) Max.

DIVIDER NETWORK 5:1

ORDERING INFORMATION

R1 = 10K:	VTF1007BX
100K:	VTF1008BX

Lead (Pb)-free option add "S" after part number, e.g: VTF1007SBX

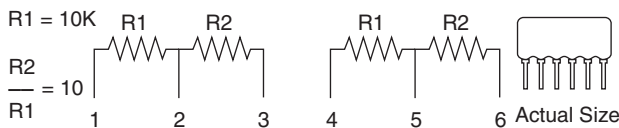

L = Total Length = 0.620" (15.75 mm) Max.
H = Seated Height = 0.280" (7.11 mm) Max.

DIVIDER NETWORK 10:1

ORDERING INFORMATION

R1 = 10K:	VTF220BX
-----------	----------

Lead (Pb)-free option add "S" after part number, e.g: VTF220SBX

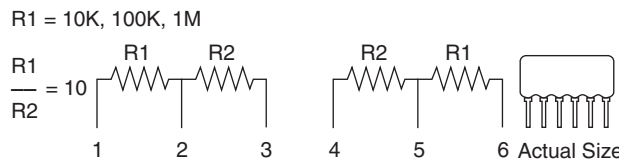

L = Total Length = 0.620" (15.75 mm) Max.
H = Seated Height = 0.280" (7.11 mm) Max.
Except PN 285 Seated Height = 0.320" (8.13 mm) Max.

DIVIDER NETWORK 10:1

ORDERING INFORMATION

R1 = 10K:	VTF328BX
100K:	VTF284BX
1M:	VTF285BX

Lead (Pb)-free option add "S" after part number, e.g: VTF328SBX

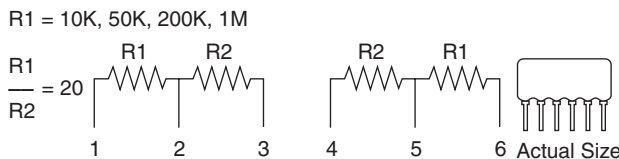

L = Total Length = 0.620" (15.75 mm) Max.
H = Seated Height = 0.280" (7.11 mm) Max.

DIVIDER NETWORK 20:1

ORDERING INFORMATION

R1 = 10K:	VTF1073BX
50K:	VTF1074BX
200K:	VTF1107BX
1M:	VTF1108BX

Lead (Pb)-free option add "S" after part number, e.g: VTF1073SBX

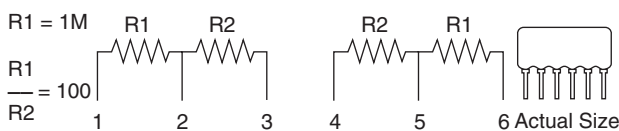

L = Total Length = 0.620" (15.75 mm) Max.
H = Seated Height = 0.280" (7.11 mm) Max.

DIVIDER NETWORK 100:1

ORDERING INFORMATION

R1 = 1M:	VTF1109BX
----------	-----------

Lead (Pb)-free option add "S" after part number, e.g: VTF1109SBX

THROUGH HOLE NETWORKS

VTF (Standard)

Vishay Thin Film Conformal, Single In-Line Resistor Networks (Standard)



Common Mode
 Division Ratio 250, 100, 50
 R1 = R3 = 1M
 R2 = 4K, 10K, 20K
 R4 = 3.984K, 9.901K, 19.608K
 R5 = 900K, 950K, 975K
 R6 = 100K, 50K, 25K

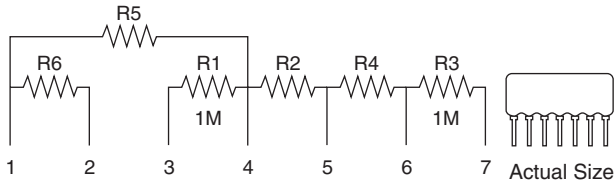

L = Total Length = 0.720" (18.29 mm) Max.
 H = Seated Height = 0.360" (9.14 mm) Max.
 Maximum voltage to pins #3 and #7 is 300 V

SIX RESISTOR NETWORK

(Designed for Unity Gain/High Common Mode Voltage Rejection Differential Amplifier)

ORDERING INFORMATION

$\frac{R1}{R2}$	= Division Ratio = 250: VTF442BX
	100: VTF443BX
	50: VTF444BX

Lead (Pb)-free option add "S" after part number, e.g: VTF442SBX

THROUGH HOLE NETWORKS

R1 = 1K, 10K, 25K, 50K, 100K

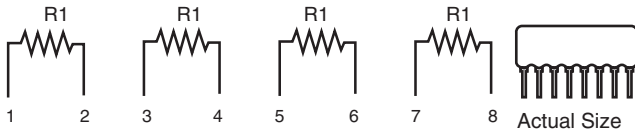

L = Total Length = 0.820" (20.83 mm) Max.
 H = Seated Height = 0.280" (7.11 mm) Max.

FOUR EQUAL RESISTORS ISOLATED

ORDERING INFORMATION

R1 = 1K:	VTF329BX
2K:	VTF1001BX
5K:	VTF1002BX
10K:	VTF158BX
25K:	VTF1003BX
50K:	VTF1004BX
100K:	VTF288BX

Lead (Pb)-free option add "S" after part number, e.g: VTF329SBX

R1 = 1K, 10K, 100K

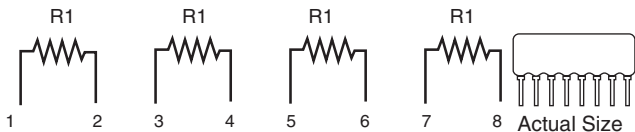

Absolute Tolerance = 0.1 %
 Ratio Tolerance = 0.1 %
 L = Total Length = 0.820" (20.83 mm) Max.
 H = Seated Height = 0.280" (7.11 mm) Max.

FOUR EQUAL RESISTORS ISOLATED

ORDERING INFORMATION

R1 = 1K:	VTF1005BX
10K:	VTF1006BX
100K:	VTF1137BX

Lead (Pb)-free option add "S" after part number, e.g: VTF1005SBX

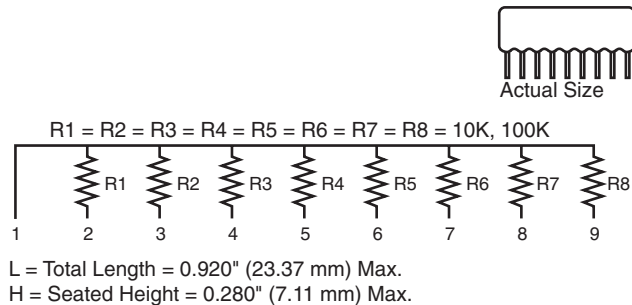

EIGHT EQUAL RESISTORS ONE COMMON

ORDERING INFORMATION	
R1 = 10K:	VTF368BX
100K:	VTF369BX

Lead (Pb)-free option add "S" after part number, e.g: VTF368SBX

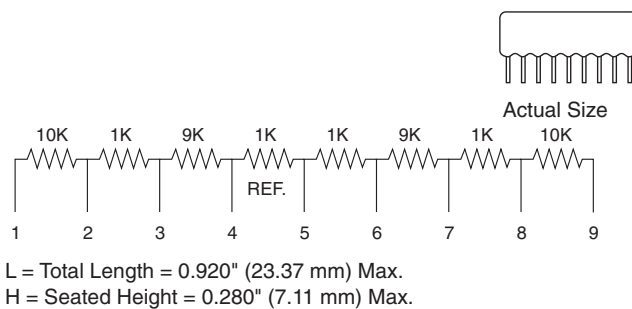

EIGHT RESISTOR NETWORK

(Designed for Instrument Amplifier with Shield Driver)

ORDERING INFORMATION	
VTF272BX	

Lead (Pb)-free option add "S" after part number, e.g: VTF272SBX

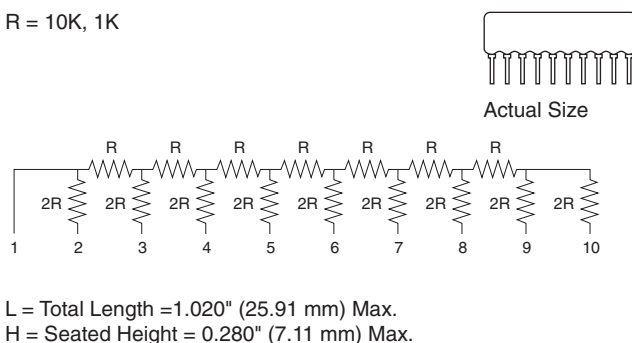

EIGHT BIT R/2R LADDER NETWORK

ORDERING INFORMATION	
(± 1/2 LSB)	
R = 1K:	VTF1072BX
R = 10K:	VTF267BX

Lead (Pb)-free option add "S" after part number, e.g: VTF1072SBX

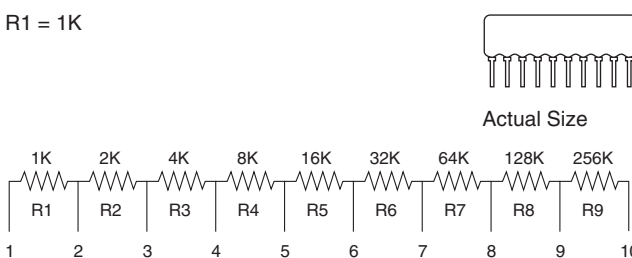

RESISTANCE DOUBLER

ORDERING INFORMATION	
VTF1011BX	

Lead (Pb)-free option add "S" after part number, e.g: VTF1011SBX

Absolute Tolerance = ± 0.1 %
Ratio Tolerance = ± 0.1 %
TCR Tracking = ± 3 ppm/°C
L = Total Length = 1.02" (25.91 mm) Max.
H = Seated Height = 0.280" (7.11 mm) Max.

THROUGH HOLE NETWORKS

STANDARD ELECTRICAL SPECIFICATIONS			
TEST		SPECIFICATIONS	CONDITIONS
Material		Passivated nichrome	
TCR*:	Tracking	± 2 ppm/ $^{\circ}$ C	0 $^{\circ}$ C to + 70 $^{\circ}$ C
	Absolute	± 10 ppm/ $^{\circ}$ C	0 $^{\circ}$ C to + 70 $^{\circ}$ C
Tolerance:	Ratio	± 0.02 %	+ 25 $^{\circ}$ C
	Absolute	± 0.1 %	+ 25 $^{\circ}$ C
Stability:	ΔR Ratio	≤ 0.01 %	2000 h at + 70 $^{\circ}$ C
Voltage Coefficient		± 0.01 ppm/V	
Working Voltage		100 V	
Operating Temperature Range		0 $^{\circ}$ C to + 70 $^{\circ}$ C	
Storage Temperature Range		- 55 $^{\circ}$ C to + 125 $^{\circ}$ C	
Noise		- 35 dB	
Thermal EMF		< 0.1 μ V/ $^{\circ}$ C	
Shelf Life Stability:	Absolute	100 ppm	1 year at + 25 $^{\circ}$ C
	Ratio	20 ppm	1 year at + 25 $^{\circ}$ C

DIMENSIONS AND IMPRINTING in inches and millimeters

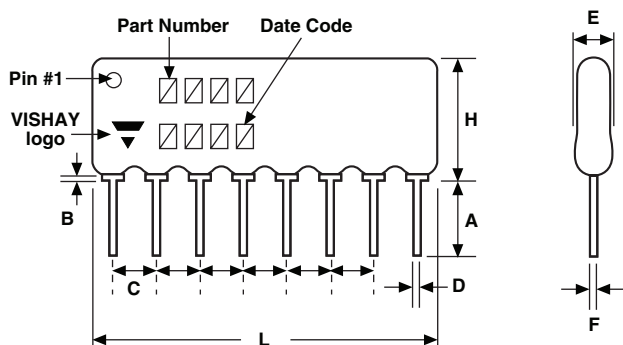

DIMENSION	INCHES	MM
A	0.125 (min.)	3.17
B	0.010 (min.)	0.25
C	0.100	2.54 typ.
D	0.020 typ.	0.51
E	0.100 max.	2.54
F	0.010 typ.	0.25

NOTE: "L" and "H" (length and height) dimensions for each model are found alongside the schematic drawing.

MECHANICAL SPECIFICATIONS	
Resistive Material	Passivated nichrome
Substrate Material	Alumina
Body	Epoxy coated
Terminals	Copper
Plating	Sn 60
Marking Resistance to Solvents	Per MIL-PRF-83401
Lead (Pb)-free Option	96.5 % Sn, 3.0 % Ag, 0.5 % Cu
Lead (Pb)-free Finish	Hot solder dip



GLOBAL PART NUMBER INFORMATION

New Global Part Numbering: VTF211BX (preferred part number format)

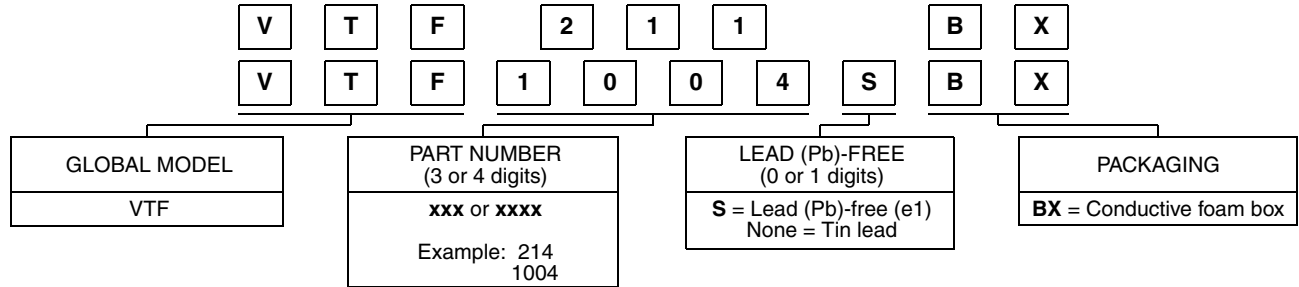

Historical Part Number example: VTF 211 (will continue to be accepted)





Disclaimer

All product specifications and data are subject to change without notice.

Vishay Intertechnology, Inc., its affiliates, agents, and employees, and all persons acting on its or their behalf (collectively, "Vishay"), disclaim any and all liability for any errors, inaccuracies or incompleteness contained herein or in any other disclosure relating to any product.

Vishay disclaims any and all liability arising out of the use or application of any product described herein or of any information provided herein to the maximum extent permitted by law. The product specifications do not expand or otherwise modify Vishay's terms and conditions of purchase, including but not limited to the warranty expressed therein, which apply to these products.

No license, express or implied, by estoppel or otherwise, to any intellectual property rights is granted by this document or by any conduct of Vishay.

The products shown herein are not designed for use in medical, life-saving, or life-sustaining applications unless otherwise expressly indicated. Customers using or selling Vishay products not expressly indicated for use in such applications do so entirely at their own risk and agree to fully indemnify Vishay for any damages arising or resulting from such use or sale. Please contact authorized Vishay personnel to obtain written terms and conditions regarding products designed for such applications.

Product names and markings noted herein may be trademarks of their respective owners.