

**NEW**

# Ultra Small Surface Mount Coaxial Connectors – 1.4mm Mated Height

W.FL Series – Further downsizing of FL series in response to the market needs.

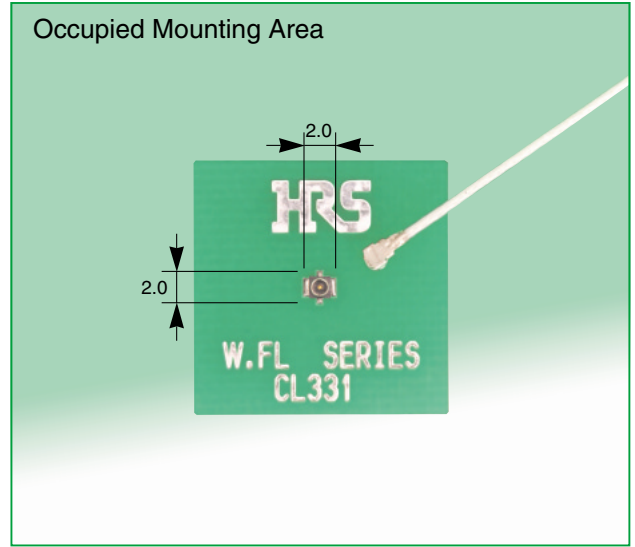
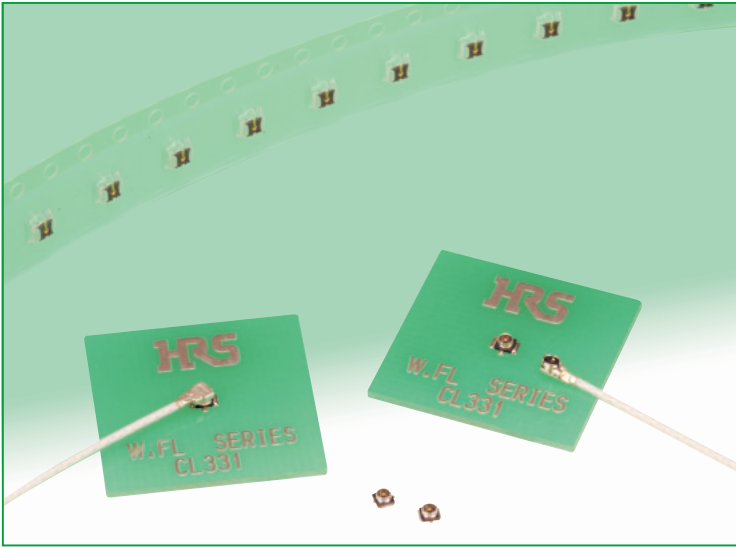

## ■ Features

1. Mounting area of only 3.4mm<sup>2</sup>
2. The board mounted receptacle weights only 5.6 mg
3. Accepts high frequency transmission of DC to 6GHz
4. Receptacle supplied on tape-and-reel for placement on the board with automatic equipment
5. Plugs are terminated with ultra-fine Teflon® insulated coaxial cables
6. Un-mating with a simple tool

## ■ Applications

Mobile phones, Wireless LAN, Bluetooth protocol devices, PDA, GPS, electronic measuring instruments and any application requiring high frequency transmission over coaxial line, where space is limited.

## ● Mated Height Comparison(With U.FL series)

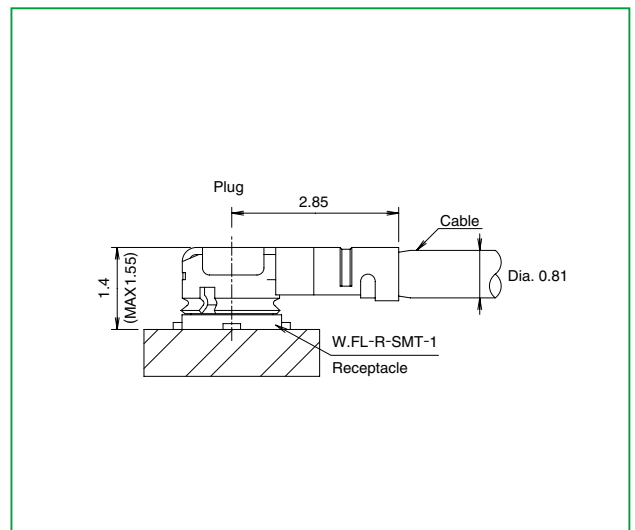
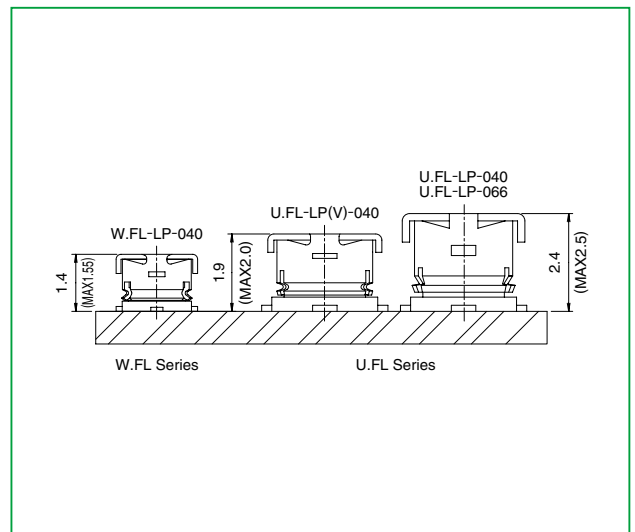

\* Teflon is a registered trademark of DuPont.

## Product Specifications

Ratings	Nominal characteristic impedance	50 ohms	Operating temperature range	-40°C to +90°C (Relative humidity 90% max.)
	Frequency range	DC to 6GHz	Operating humidity	-40°C to +70°C (Relative humidity 90% max.)

## Materials and Finishes

Item	Specification
1. Contact resistance	Center: 20m ohms max. Outside: 10m ohms max.
2. Insulation resistance	500M ohms min., 100V DC
3. Withstanding voltage	200V AC / 1 minute
4. V.S.W.R.(Note)	1.3 max. (Up to 3GHz)
	1.35 max. (3 to 6GHz)

Note:V.S.W.R. Measurement System

Measured as shown on the block diagram below.

Test connection and measurement setup.

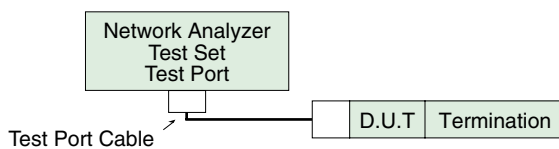

Note1:Cable type connector measurements.

With SMA conversion adapters mated with W.FL plug at each end of the 100cm long ultra-fine coaxial cable.

Note2:Board type connector measurements.

Mounted on a 50 ohms glass epoxy board. Measurements were conducted with SMA conversion adapters attached.

## Material/Finishes

Part	Component	Material	Finish/Remarks
Plug	Shell	Phosphor bronze	Silver plated
	Insulator	PBT	Black, UL94V-0
	Socket center contact	Phosphor bronze	Gold plated
Receptacle	Shell	Phosphor bronze	Silver plated
	Insulator	LCP	Black, UL94V-0
	Pin center contact	Brass	Gold plated

## Plug

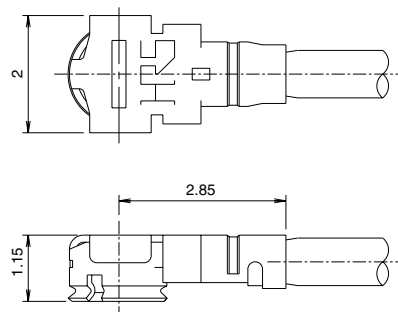
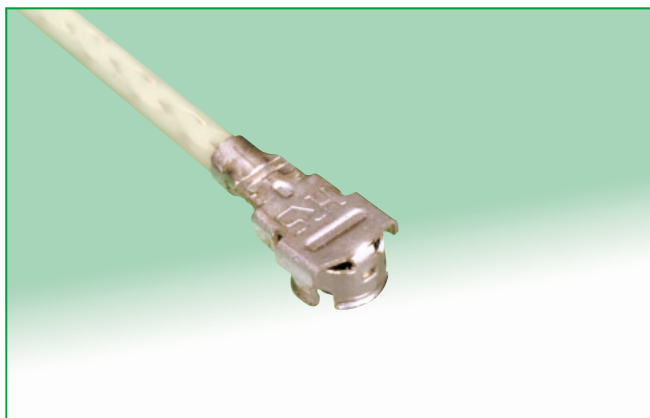

Plugs can be ordered only terminated to the cable.

## How to Specify Cable Assembly

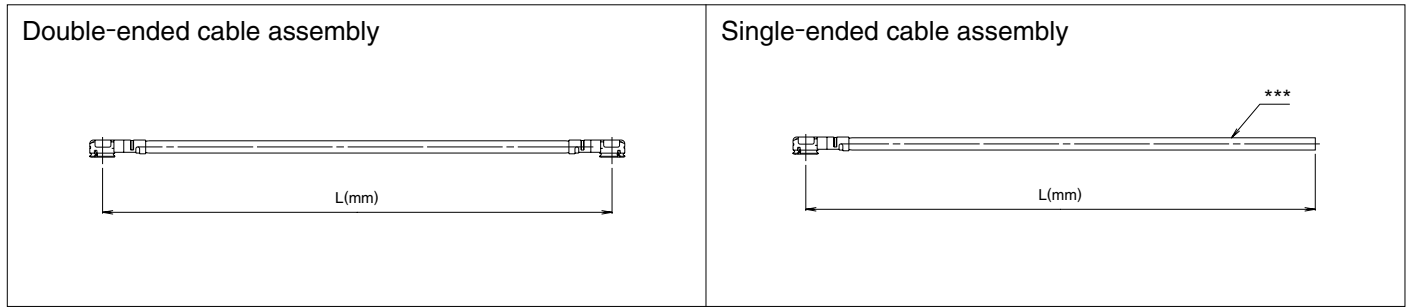

### Ordering Information

**W.FL - 2LP - 04N [ ] - A - (L)**

①            ②            ③    ④            ⑤

① Series name	W.FL
② Assembly type	LP : Single ended 2LP: Double ended
③ Cable type	04N: 0.81mm dia. ultra-fine coaxial cable
④ Cable color	1: White, 2: Black
⑤ Total length (mm)	Length (L)

### Standard tolerances for (L)\*\*

(L)(mm)	Standard Tolerance (mm)
*L=35 to 200	±4
L=200 to 500	±8
L=500 to 1000	±12
L=1000 →	±1.5% of (L)

\*Minimum available length (L) is 35mm

\*\*Contact nearest HRS representative if different tolerances are required.

\*\*\*Contact Nearest HRS representative if one end requires preparation.

## Receptacle

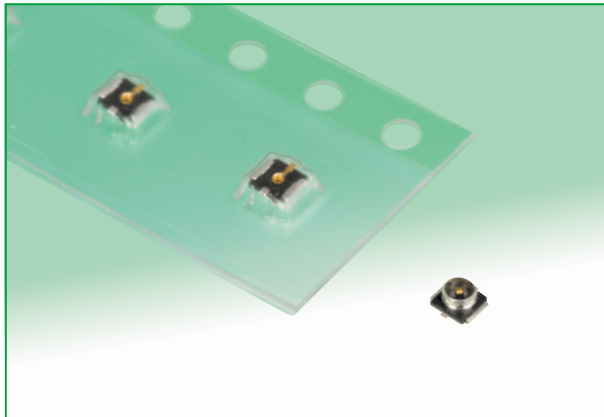

### Recommended PCB Mounting Pattern

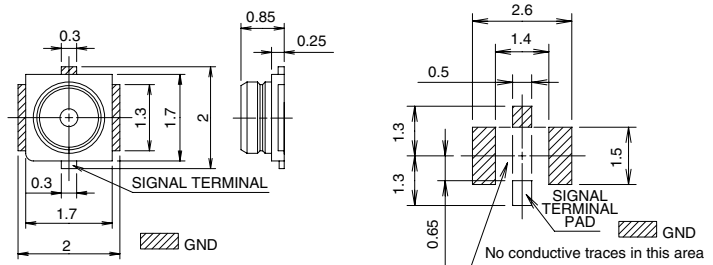

Recommended screen thickness: 0.1mm to 0.12mm

Part Number	CL No.	Packaging	Weight / EA
W.FL-R-SMT-1(10)	331-0482-6-10	Reel packaging (2000 pieces/reel)	5.6 mg

## ■ Conversion Adapters

### ● SMA Conversion Adapter (W.FL side jack – SMA side plug)

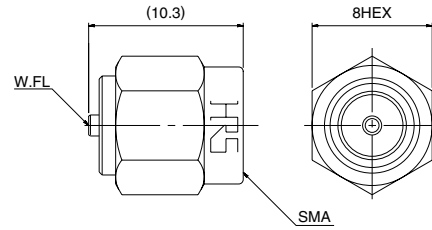
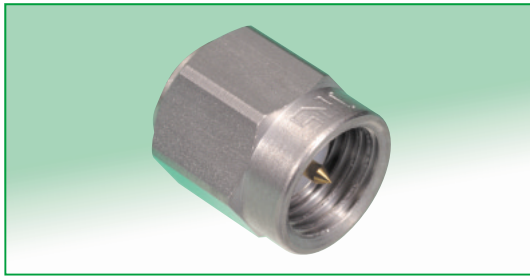

Note:Used for performance measurements only.  
The W.FL mating side has lower retention force than the regular product when mated to the corresponding part.

Part No.	CL No.
HRMP-W.FLJ	311-0367-3

### ● SMA Conversion Adapter (W.FL side plug – SMA side jack)

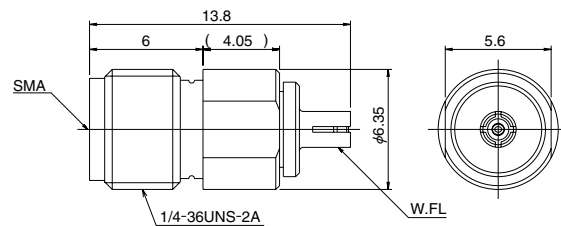

Note:Used for performance measurements only.  
The W.FL mating side has lower retention force than the regular product when mated to the corresponding part.

Part No.	CL No.
HRMJ-W.FLP	311-0368-6

### ● SMA Conversion Adapter

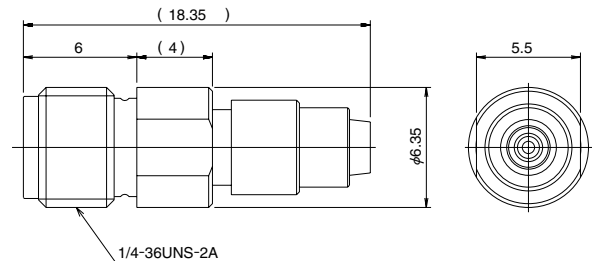

Note:When mating with corresponding part (W.FL-R-SMT-1) it must be pressed down and held to make complete connection.

Part No.	CL No.
HRMJ-W.FLP-ST1	311-0386-8

## ■ Receptacle Inspection Adapter

### ● Used for inspecting the performance parameters of the cable assembly.

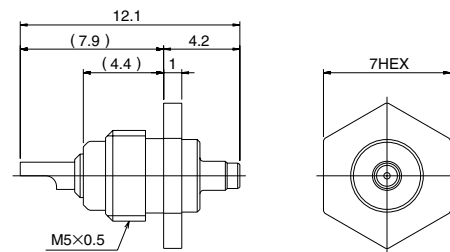
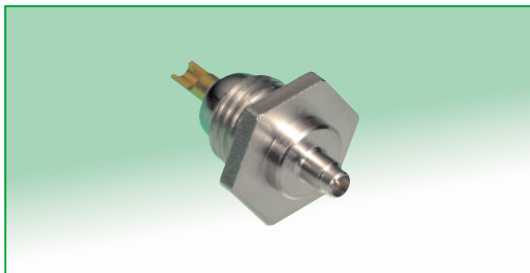

Part No.	CL No.
W.FL-R-1	331-0483-9

## ■ Plug Extraction Tool-Used for Un-mating of the plug

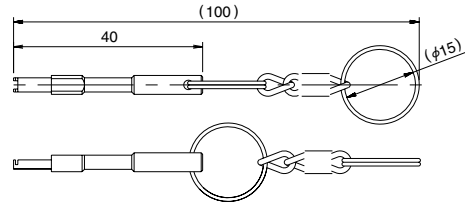

Part No.	CL No.
W.FL-LP-N	331-0492-0

## ◆ Packaging Specifications- Receptacle

W.FL-R-SMT-1(10)

### Embossed Carrier Tape Dimensions

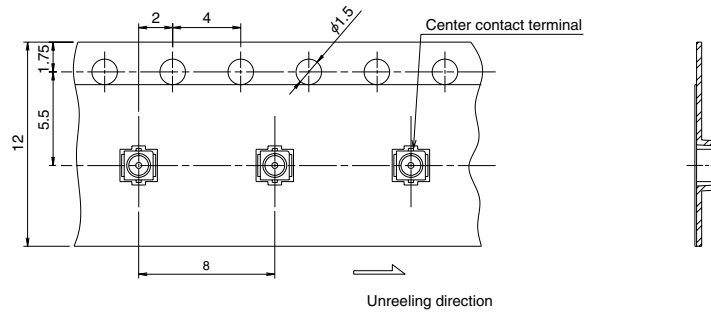

### Reel Dimensions

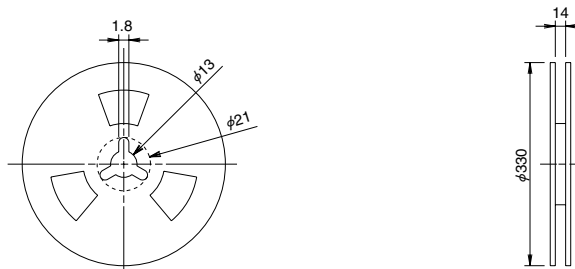

## Usage Precautions

### 1. Plugs

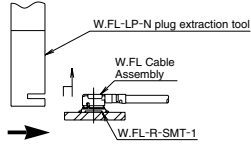
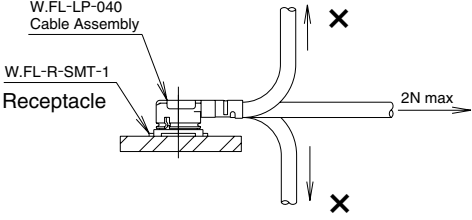
<p>(1) Mating/ un-mating</p>	<p>1) Mating. Both parts must be aligned on the axis to mate correct. Press down firmly. A tactile “click” will confirm fully mated condition.</p> <p>2) Un-mating. Fully insert the tool under the plug’s flanges as shown. Apply even force upward until the plug is free.</p> 
<p>(2) Cable handling</p>	<p>Do not twist, apply excessive forces or sharp bends to the cable.</p> 
<p>(3) Precautions</p>	<p>Do NOT forcefully twist or deform wires.</p>

### 2. Receptacles

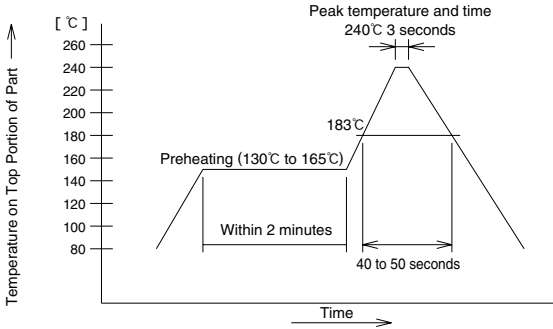
<p>(1) Recommended soldering temperature profile</p>	 <p>1) The temperature profile indicates the board surface temperature at the point of contacts with the connector terminals.</p> <p>2) The temperature may vary, depending on the board size, the solder paste type and thickness.</p>
<p>(2) Recommended screen thickness</p>	<p>0.1 to 0.12 mm</p>



## HIROSE ELECTRIC CO.,LTD.

5-23,OSAKI 5-CHOME,SHINAGAWA-KU,TOKYO 141-8587,JAPAN  
 PHONE: 81-3-3491-9741, FAX: 81-3-3493-2933  
<http://www.hirose.com>  
<http://www.hirose-connectors.com>