



FLASH VR CONTROLLER

GENERAL DESCRIPTION

The W51300 is a voice recorder IC which contains A/D and D/A converters to digitize and reproduce voice signals. An anti-alias/smoothing filter, AGC circuit, MIC preamplifier, and speaker power amplifier are used to smooth the input voice and set the output voice to a certain volume while minimizing the number of extra components needed. The recording time depends on the size of the external memory.

The external memory is a nonvolatile flash EPROM that stores the voice data while power is switched off. This external memory provides a great advantage in cartridge or greeting card applications. A maximum of 16 Mbit of memory can be cascaded. In addition, the W51300's flexible segmentation, selective recording/erasing, forward and backward move functions, and MCU interface provide flexibility to meet the needs of a wide variety of applications.

FEATURES

- Modified ADM algorithm with 24 KHz sampling frequency when $R_{osc} = 620\text{ K}\Omega$
- Operates with Winbond serial flash EPROM
- Built-in A/D, D/A, MIC preamplifier, AGC circuit, anti-alias/smoothing filter, speaker power amplifier, and LED indicator
- 8 input trigger pins (L_REC, E_PLAY, L_PLAY, FWD, BWD, STOP, ERASE, RESET) debounced to ensure noise-free operations
- Single/multi-voice segment operation, normal/CPU mode selected by pin option (SMODE, CPU)
- Cascadable for longer duration by directly cascading serial flash EPROMs (maximum 16 Mbits)
- Maximum 63 voice segments available in multi-segment operation
- Provides selective record, erase, and playback functions
- Provides low power detection circuit at 3.0V
- Provides both speaker direct drive and speaker current output (5 mA)
- Low power consumption:
 - Operating: 15 mA (typ.)
 - Standby: 0.01 μA (typ.)

PIN CONFIGURATION

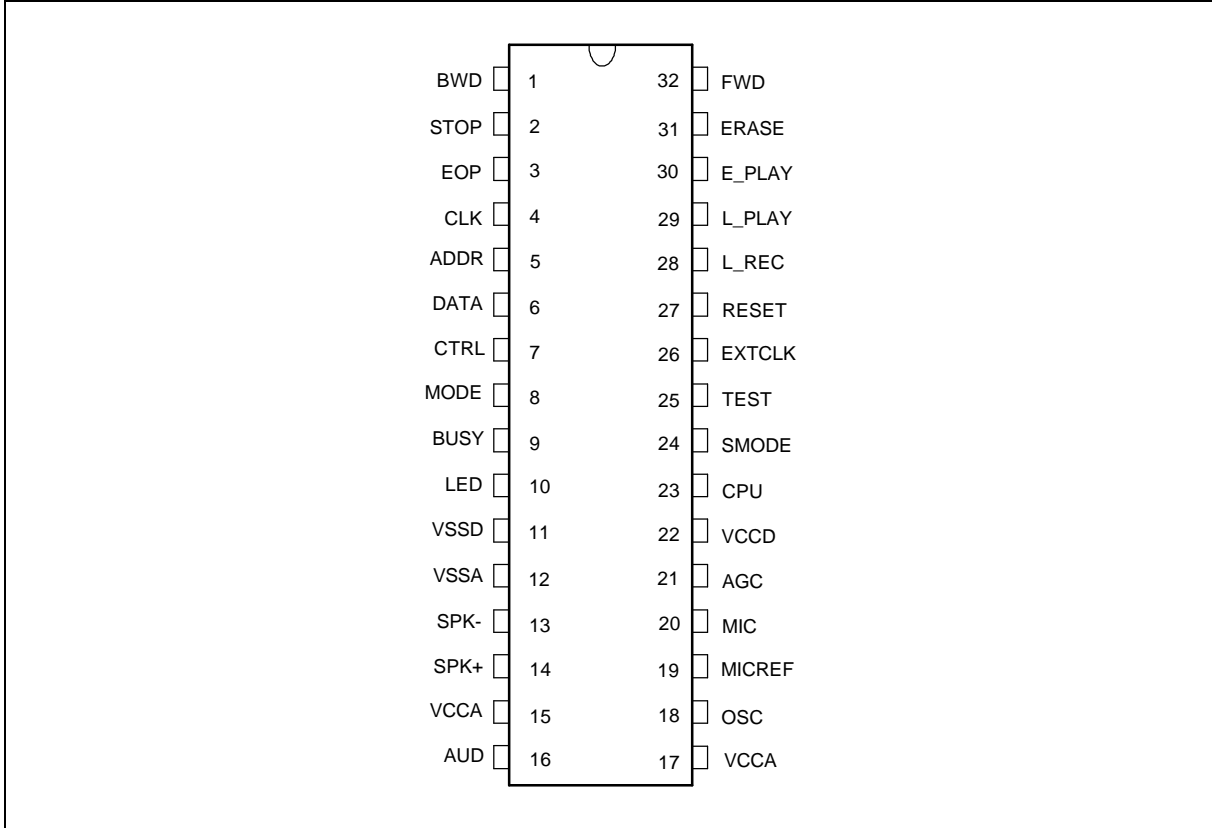

PIN DESCRIPTION

NO.	PIN	I/O	DESCRIPTION
1	BWD	I/O	Message backward control pin in normal mode Output clock signal (to MCU) in CPU mode
2	STOP	I	Stop playback control pin in normal mode Input clock signal (from MCU) in CPU mode
3	EOP	I	End of page process signal (from flash EPROM)
4	CLK	O	Data clock pin for flash EPROM
5	ADDR	O	Address clock pin for flash EPROM
6	DATA	I/O	Bidirectional data pin for flash EPROM
7	CTRL	O	Control signal for flash EPROM
8	MODE	O	Mode control pin for flash EPROM



Pin Description, continued

NO.	PIN	I/O	DESCRIPTION
9	BUSY	O	Output busy signal, HIGH during playback
10	LED	O	Blink (Flash (volume-controlled) during playback Flash Blink (3 Hz) when during low battery is low, segment full, or memory full ON during recording, erasing, and memory formatting
11	VSSD	-	Digital negative power supply
12	VSSA	-	Analog negative power supply
13	SPK-	O	Speaker voltage output -
14	SPK+	O	Speaker voltage output +
15	VCCA	-	Analog positive power supply
16	AUD	O	Speaker current output (maximum 5 mA when Vcc = 4.5V)
17	VCCA	-	Analog positive power supply +
18	OSC	I	Oscillation frequency control pin
19	MICREF	I	Microphone reference
20	MIC	I	Microphone input
21	AGC	I	Automatic gain control input
22	VCCD	-	Digital positive power supply
23	CPU	I	Normal/CPU mode select pin: low for normal, high for CPU
24	SMODE	I	Multi/single segment select pin: low for multi, high for single
25	TEST	I	External test pin for testing
26	EXTCLK	I	External clock pin for testing
27	RESET	I	Reset control pin
28	L_REC	I	Level record control pin
29	L_PLAY	I	Level playback control pin
30	E_PLAY	I	Edge playback control pin
31	ERASE	I	Message erase control pin in normal mode Input level signal (from MCU) in CPU mode
32	FWD	I/O	Message forward control pin in normal mode Output level signal (to MCU) in CPU mode

BLOCK DIAGRAM

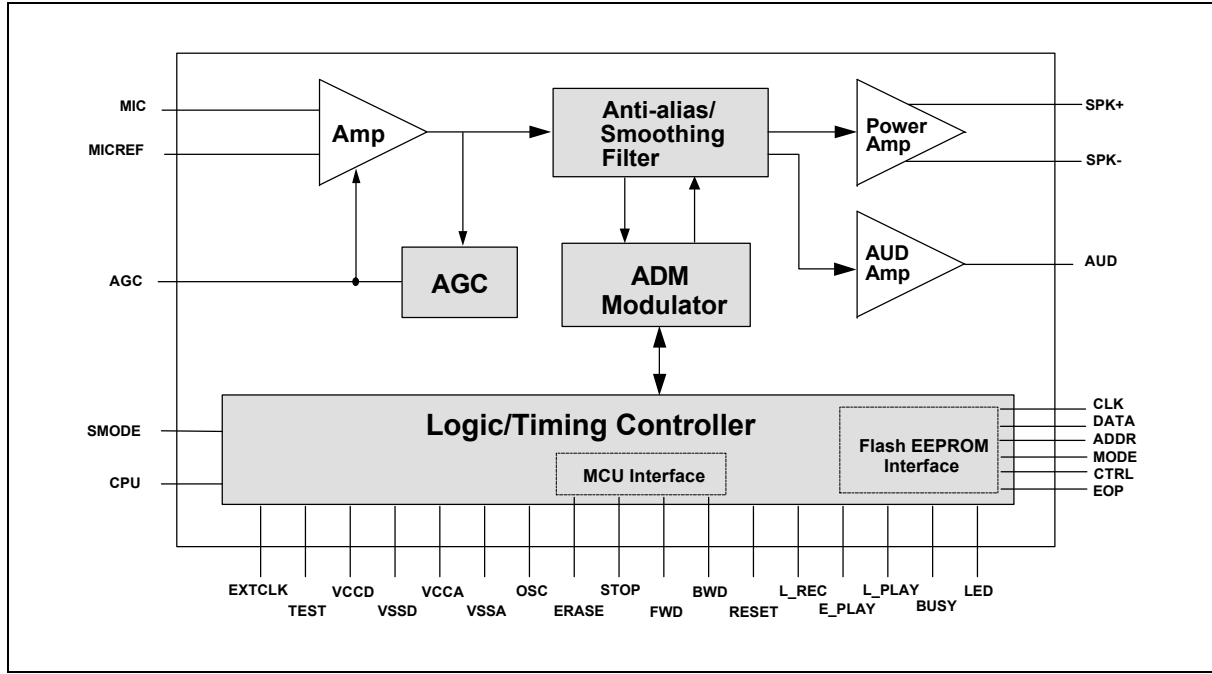

FUNCTIONAL DESCRIPTION

1. Single/Multi-segment Operation

The W51300 is typically used for either single or multi-segment operations. Single or multi-segment operating mode is selected by pin option.

Single Segment

The SMODE pin should be connected to Vcc. In this mode, only one voice segment can be recorded. The storage duration can be extended by cascading serial flash EPROMs; up to 16 Mbits of memory can be cascaded.

Multi-segment

The SMODE pin should be connected to Vss or left floating. In this mode, a maximum of 63 voice segments can be recorded into flash EPROMs; up to 16 Mbits of memory can be cascaded. Messages can easily be accessed by using the FWD, BWD, and PLAY pins.

2. Selective Record

When the system is operated in multi-segment mode, voice segments can be recorded selectively. Users can insert a voice segment between any two existing voice segments. For instance, suppose there are already five voice segments, 1, 2, 3, 4, and 5, and the CAP (current address/message pointer) is at 3. Then a newly recorded voice segment will be assigned the number 4, and the original segments 4 and 5 will be changed to 5 and 6, respectively. If the maximum number of voice segments (63) or the end of memory space has been reached, a press of L_REC will be invalid and the LED will flash at 3 Hz for 2 seconds to indicate the invalid action.



3. Selective Erase

When the system is operated in multi-segment mode, voice segments can be erased selectively instead of sequentially. Users can play the voice segments one by one until they reach the segment to be erased, and then stop playing and press the ERASE key. The current voice segment will be erased and the CAP value will be changed to the previous voice segment. The LED will light during the erasing procedure to indicate that the system is busy, and all input triggers will be disabled except for RESET.

4. Chip Erase

Pressing and holding the RESET key for more than two seconds will clear all data in the flash EPROM.

5. Function Keys

In normal mode, eight input trigger pins with built-in debounce circuitry are used to operate the W51300. These eight pins are described below.

L_REC

L_REC is an active-high, level-triggered recording pin with an internal 500 K Ω pull-low resistor. When this pin goes high, the device starts recording and continues until this pin is released or the end of the memory space is reached. When the memory or segment is full, this pin is invalid.

E_PLAY

E_PLAY is an active-high, edge-triggered playback pin with an internal 500 K Ω pull-low resistor. In single segment operation, the toggle stop function is enabled. This means a debounced rising edge on E_PLAY during voice playing will stop the ongoing playback operation immediately. In multi-segment operation, the toggle skip function is enabled. This means a debounced rising edge on E_PLAY during voice playing will cause the device to skip to the next voice segment. A rising edge on this pin while the last voice segment is being played will cause the device to skip to the first voice segment. This function is useful for fast scanning through a series of messages.

L_PLAY

L_PLAY is an active-high, level-triggered playback pin with an internal 500 K Ω pull-low resistor. The current voice segment will be played back when this pin is pressed. A concatenated loop playing function is enabled to link all messages in a row and loop back to the first message when the last message is reached.

STOP

This is an active-high, edge-triggered stop pin with an internal 500 K Ω pull-low resistor. Pressing this pin immediately stops playback of the ongoing message. This pin is enabled only while a voice is playing.

ERASE

ERASE is an active-high, edge-triggered erase pin with an internal 500 K Ω pull-low resistor. Pressing this pin erases the current voice segment without affecting the content of the other segments.

FWD

This is an active-high, edge-triggered forward pin with an internal 500 K Ω pull-low resistor. Pressing this pin for less than 1 second moves the CAP from the current voice segment to the next one. Pressing this pin for more than 1 second moves the CAP from the current voice segment to the last one.



BWD

This is an active-high, edge-triggered backward pin with an internal 500 K Ω pull-low resistor. Pressing this pin for less than 1 second moves the CAP from the current voice segment to the previous one. Pressing this pin for more than 1 second moves the CAP from the current voice segment to the first one.

RESET

This is an active-high, edge-triggered reset pin with an internal 500 K Ω pull-low resistor. Pressing this pin for less than 2 seconds causes the system power-on initialization procedure to be executed and resets the message pointer to 1. Pressing this pin for more than 2 seconds executes the chip erase procedure, so that all of the recorded messages are cleared.

6. Low Battery Warning

A low battery warning function is provided to protect the recorded voice messages from being lost due to loss of power. Before a recording, erasing, or reset operation, the battery voltage will be checked. If the voltage falls to 3 volts or below, all operations except the LED stop, and the LED flashes at 3 Hz for 2 seconds to indicate that the battery is low.

7. Speaker Output

The W51300 provides two types of speaker drivers, direct drive and current output. The direct drive is a voltage output from the built-in power amplifier. This output can be used to drive a speaker directly without any extra components, such as resistors or transistors. The maximum driving current is 56 mA (rms) when the output is connected to a 16 Ω speaker. The current output is the same as that of the standard speaker driver used in most Winbond *PowerSpeech*[™] chips. The maximum driving current is 5 mA when $V_{CC} = 4.5V$.

8. Sampling Frequency Adjustment

The external ROSC can be adjusted to change the system clock (F_{osc}) and sampling frequency (F_s). The relationship between F_{osc} and F_s is $F_s = F_{osc}/32$. The relationship between F_s and ROSC is shown in the figure below.

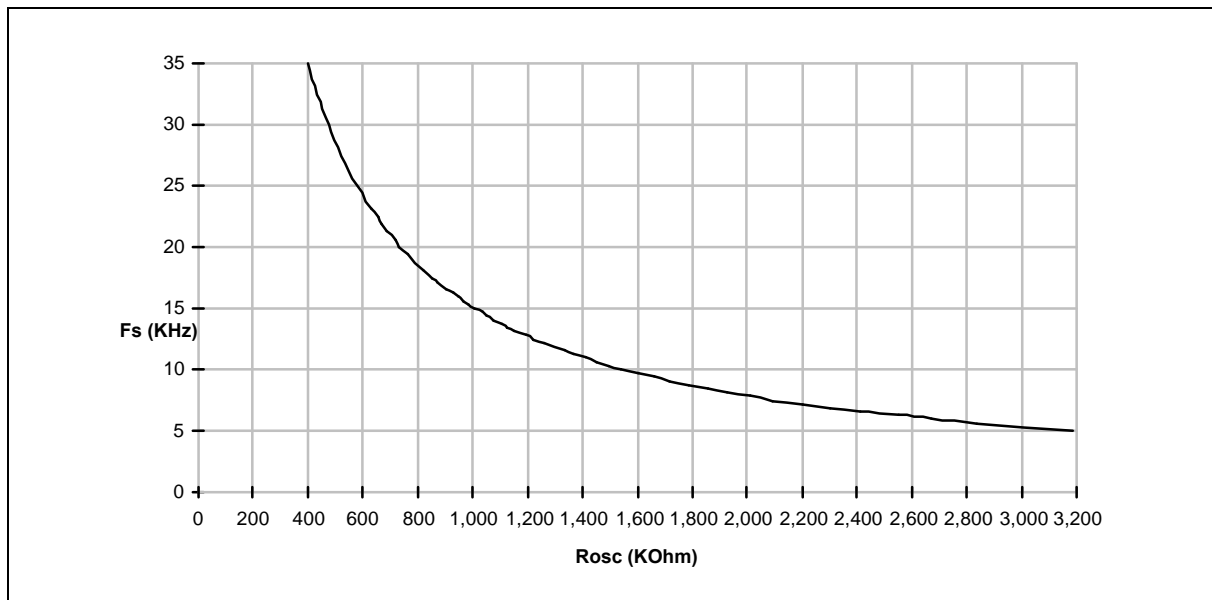

9. MCU Interface

In CPU mode, five pins can be used as an MCU interface to communicate with external micro-controllers by the counter method. RESET, ERASE, STOP are configured as input pins, while FWD and BWD are configured as output pins. The application diagram is shown below.

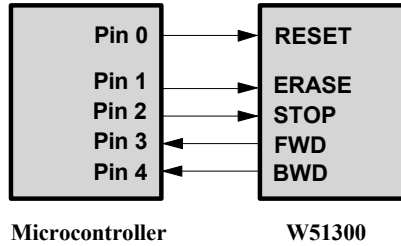

The W51300 offers 10 operating modes that can be controlled by a microcontroller. The rising edge of pin 1 informs the W51300 to begin to count the pulses generated on pin 2, and the falling edge of pin 1 informs the W51300 to latch the pulse number. Then the number of pulses is decoded to instruct the W51300 to perform various operations. The operating modes and the corresponding waveforms are shown below.

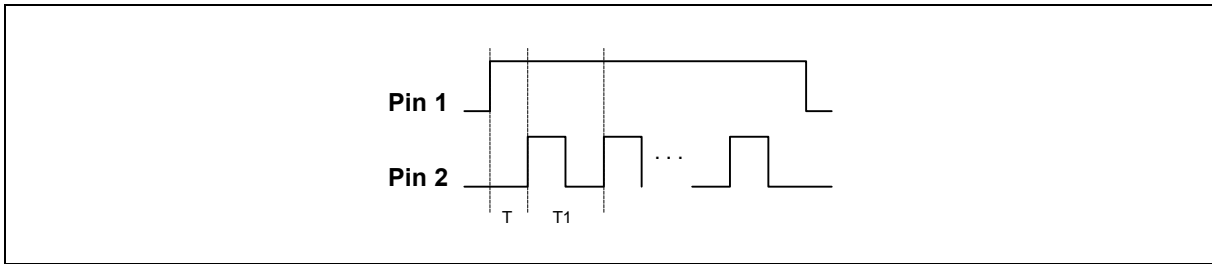

Note: T is 5 μS minimum at Fosc = 768 KHz.

T1 is 10 μS minimum at Fosc = 768 KHz.

ITEM	MODE NAME	NUMBER OF PULSES ON PIN 2
1	Record	1
2	Play	2
3	Erase	3
4	Stop (for record and play)	4
5	Memory Reset	5
6	System Reset	6
7	Read CAP (Current Address Pointer)	7



Continued

ITEM	MODE NAME	NUMBER OF PULSES ON PIN 2
8	Read ASN (Available Segment Number)	8
9	Store 4 Bytes Data to Flash EPROM	9
10	Read 4 Bytes Data from Flash EPROM	10

After receiving a command from the microcontroller, the W51300 will send back a corresponding response, as shown below.

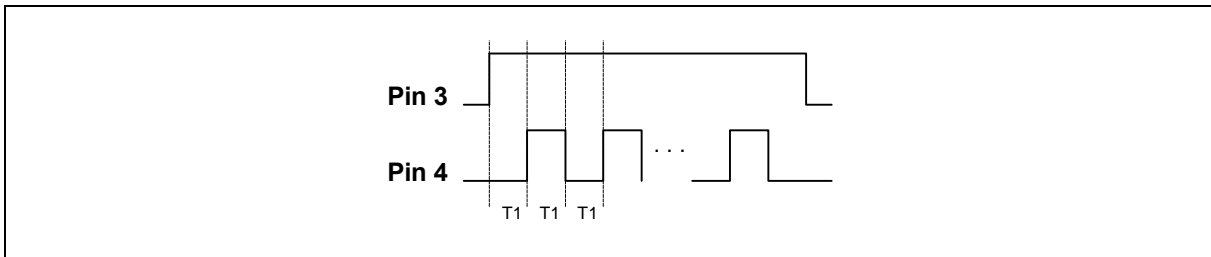

Note: T1 is 5 msec at Fosc = 768 KHz.

ITEM	MODE NAME	NUMBER OF PULSES GENERATED ON PIN 4
1	Accept	0
2	Error: Low Battery	1
3	Error: Memory Full	2
4	Error: Out of Segments	3
5	Error: Wrong CAP	4
6	Unknown Mode	5
7	Unknown Error	6

When pin 3 is low and pin 4 is high, the W51300 is busy.

ABSOLUTE MAXIMUM RATINGS

PARAMETER	SYMBOL	CONDITION	RATED VALUE	UNIT
Operating Temp.	TOPR	-	0 to +70	°C
Storage Temp.	TSTG	-	-55 to +150	°C
Power Supply	VCC-VSS	-	-0.3 to +7.0	V
Input DC Voltage	VIN	All pins	Vss -0.3 to Vcc +0.3	V

Note: Exposure to conditions beyond those listed under Absolute Maximum Ratings may adversely affect the life and reliability of the device.



DC CHARACTERISTICS

(V_{CC} = 5V, V_{CC} = 0V, T_A = 25° C)

PARAMETER		SYM.	CONDITIONS	LIMITS			UNIT
				MIN.	TYP.	MAX.	
Operating Voltage		V _{CC}	-	3.0	4.5	5.5	V
Standby Current		I _{SB}	All inputs = GND Data = 5V	0	0.01	1	μA
Operating Current		I _{OP}	No load	-	15	25	mA
Input Voltage	High	V _{IH}	All input pins	2.0	-	-	V
	Low	V _{IL}		-	-	0.8	V
Input Low Current		I _{IL}	V _{IN} = 0V	0	-	1	μA
Input High Current	Digital pins	I _{IH1}	V _{IN} = 5V	5	8	12	μA
	Analog pins, MIC	I _{IH2}	V _{IN} = 5V	0.8	1	1.2	mA
	S _{MODE} , CPU	I _{IH3}	V _{IN} = 5V	-	-	1	μA
	TEST, EXTCLK	I _{IH4}	V _{IN} = 5V	50	75	100	μA
Output Low Current	ADDR, CLK, MODE, CTRL, DATA	I _{OL1}	V _{Out} = 0.5V	0.5	1.5	3	mA
	LED, BUSY	I _{OL2}	V _{Out} = 0.5V	6	10	15	mA
Output High Current	ADDR, CLK, MODE, CTRL, DATA	I _{OH1}	V _{Out} = 4.5V	-0.5	-1.5	-3	mA
	LED, BUSY	I _{OH2}	V _{Out} = 4.5V	-2.5	-4.5	-6.5	mA
Oscillation Frequency		F _{OSC}	R _{OSC} = 620 KΩ	610	768	920	KHz



AC CHARACTERISTICS

(V_{CC} = 5V, V_{CCS} = 0V, T_A = 25° C)

PARAMETER		SYM.	CONDITIONS	LIMITS			UNIT
				MIN.	TYP.	MAX.	
Input Debounce Time	Normal mode	TDEB1	FOSC = 768 KHz	21	32	42.7	mS
	CPU mode	TDEB2		1.27	1.9	2.54	μS
CLK Duty Cycle	Write	TCLK1	-	-	50	-	%
	Read	TCLK2	-	-	75	-	%
CLK Frequency	Write	FCLK1	FOSC = 768 KHz	-	384	-	KHz
	Read	FCLK2		-	192	-	KHz
ADDR Duty Cycle		TADDR	-	-	50	-	%
ADDR Frequency		FADDR	FOSC = 768 KHz	-	384	-	KHz
Input Clock Duty Cycle of Erase Pin		TIN	CPU mode	40	-	60	%
Input Clock Frequency of Erase Pin		FIN	CPU mode	-	-	100	KHz
Output Clock Duty Cycle of BWD Pin		TOUT	CPU mode	-	50	-	%
Output Clock Frequency of BWD Pin		FOUT	CPU mode, FOSC = 768 KHz	-	100		Hz

ANALOG CIRCUIT CHARACTERISTICS

(V_{CC} = 5V, V_{SS} = 0V, T_A = 25° C)

PARAMETER	SYM.	CONDITIONS	LIMITS			UNIT
			MIN.	TYP.	MAX.	
MIC Input Voltage	VMIC	Peak to Peak	-	-	20	mV
MIC Input Resistance	RMIC	-	-	10	-	KΩ
Passband of LPF	BW	FOSC = 768 KHz	-	3.5	-	KHz
Speaker Output Power	POUT	R _{EXT} = 16Ω, rms	-	-	50	mW
Speaker Voltage Output	VOUT	R _{EXT} = 600Ω	-	-	1.2	V _{P-P}
Speaker Current Output	IAUD	V _{CC} = 4.5V, R _L = 100Ω	-4.0	-5.0	-6.0	mA
Speaker Resistance	RSP	-	8	16	-	Ω

TYPICAL APPLICATION CIRCUIT (for reference only)

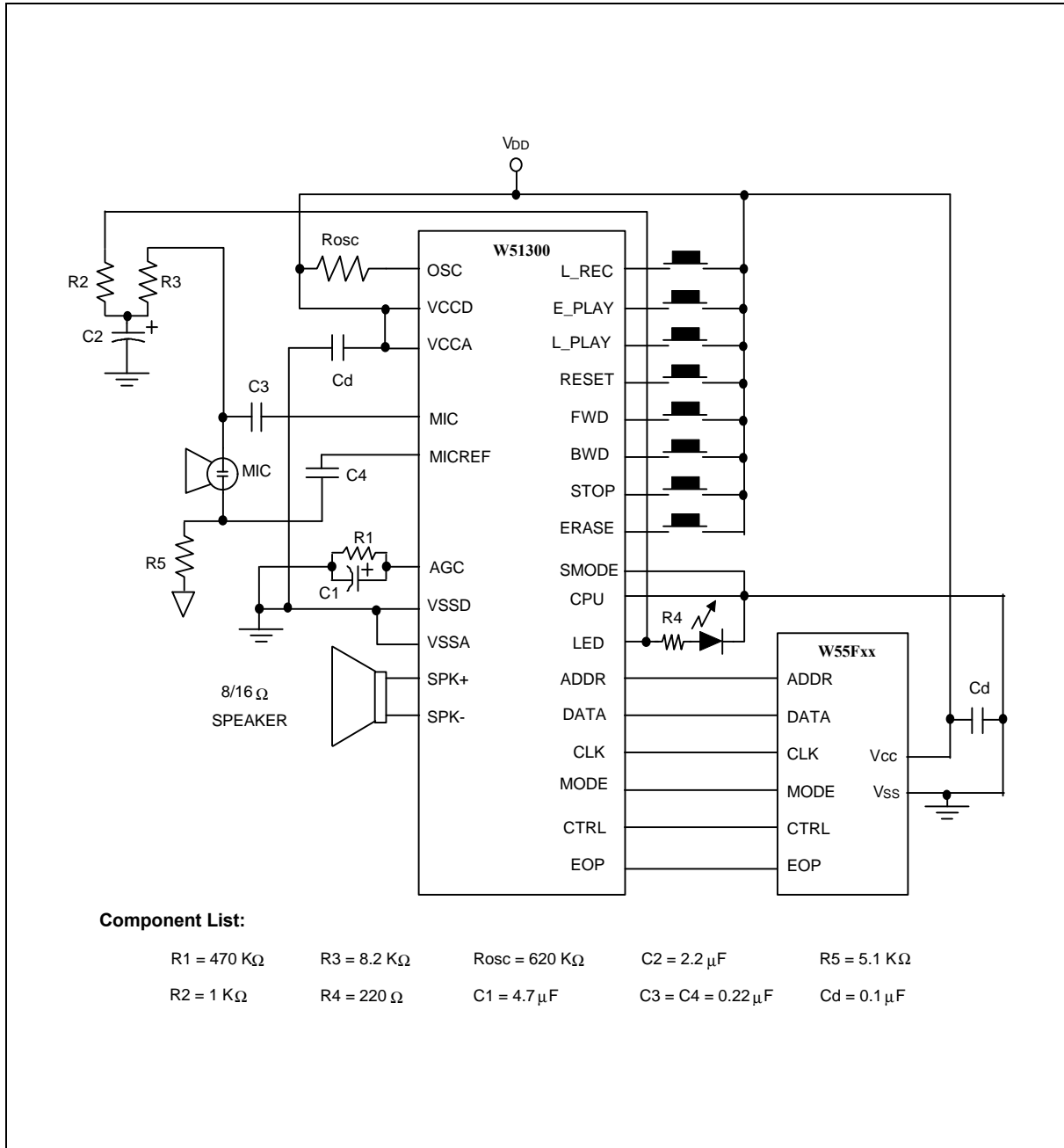

Notes:

1. R1 and C1 can be adjusted for different AGC attack time and release time.
2. Set C3 = C4 to reduce ground noise.



Headquarters

No. 4, Creation Rd. III,
Science-Based Industrial Park,
Hsinchu, Taiwan
TEL: 886-3-5770066
FAX: 886-3-5792697
<http://www.winbond.com.tw/>
Voice & Fax-on-demand: 886-2-7197006

Taipei Office

11F, No. 115, Sec. 3, Min-Sheng East Rd.,
Taipei, Taiwan
TEL: 886-2-7190505
FAX: 886-2-7197502

Winbond Electronics (H.K.) Ltd.

Rm. 803, World Trade Square, Tower II,
123 Hoi Bun Rd., Kwun Tong,
Kowloon, Hong Kong
TEL: 852-27516023
FAX: 852-27552064

Winbond Electronics North America Corp.

Winbond Memory Lab.
Winbond Microelectronics Corp.
Winbond Systems Lab.
2730 Orchard Parkway, San Jose,
CA 95134, U.S.A.
TEL: 1-408-9436666
FAX: 1-408-9436668

Note: All data and specifications are subject to change without notice.