



W83176R-732
Data Sheet

WINBOND
2 DIMM DDR ZERO
DELAY BUFFER
FOR
SIS CHIPSET

Table of Contents-

1.	GENERAL DESCRIPTION	1
2.	FEATURES	1
3.	PIN CONFIGURATION	1
4.	BLOCK DIAGRAM	2
5.	PIN DESCRIPTION.....	2
5.1	Clock Outputs	3
5.2	Power Pins.....	3
6.	REGISTER 0 ~ REGISTER 4 RESERVED	4
6.1	Register 5: Output Control (1 = Active, 0 = Inactive) (Default = FFh).....	4
6.2	Register 6: Output Control (1 = active, 0 = inactive) (Default = FFh)	4
7.	ACCESS INTERFACE	5
7.1	Block Write Protocol	5
7.2	Block Read Protocol.....	5
7.3	Byte Write Protocol.....	5
7.4	Byte Read Protocol	5
8.	SPECIFICATIONS	6
8.1	Absolute Maximum Ratings	6
8.2	A.C. Characteristics.....	6
8.3	D.C. Characteristics	6
9.	ORDERING INFORMATION.....	7
10.	HOW TO READ THE TOP MARKING	7
11.	PACKAGE DRAWING AND DIMENSIONS.....	8
12.	REVISION HISTORY	9

W83176R-732



1. GENERAL DESCRIPTION

The W83176R-732 is a 2.5V Zero-delay D.D.R. Clock buffer designed for SiS chipset. W83176R-732 can support 2 D.D.R. DRAM DIMMs.

The W83176R-732 provides I²C serial bus interface to program the registers to enable or disable each clock outputs. The W83176R-732 accepts a reference clock as its input and runs on 2.5V supply.

2. FEATURES

- Zero-delay clock outputs
- Feedback pins for synchronous
- Supports up to 2 D.D.R. DIMMs
- One pairs of additional outputs for feedback
- Low Skew outputs (< 100 pS)
- Supports 400 MHz D.D.R. SDRAM
- ²C 2-Wire serial interface and supports Byte or Block Date RW
- Packaged in 28-pin SSOP

3. PIN CONFIGURATION

CLKC3	1	28	GND
CLKTC	2	27	CLKC5
VDD	3	26	CLKT5
CLKT1	4	25	CLKC4
CLKC1	5	24	CLKT4
GND	6	23	VDD
SCLK*	7	22	SDATA*
CLK_INT	8	21	NC
NC	9	20	FB_INT
AVDD	10	19	FB_OUTT
GND	11	18	NC
VDD	12	17	CLKT3
CLKT2	13	16	CLKC2
CLKC2	14	15	GND

*: Internal pull-up resistor 120K to VDD



4. BLOCK DIAGRAM

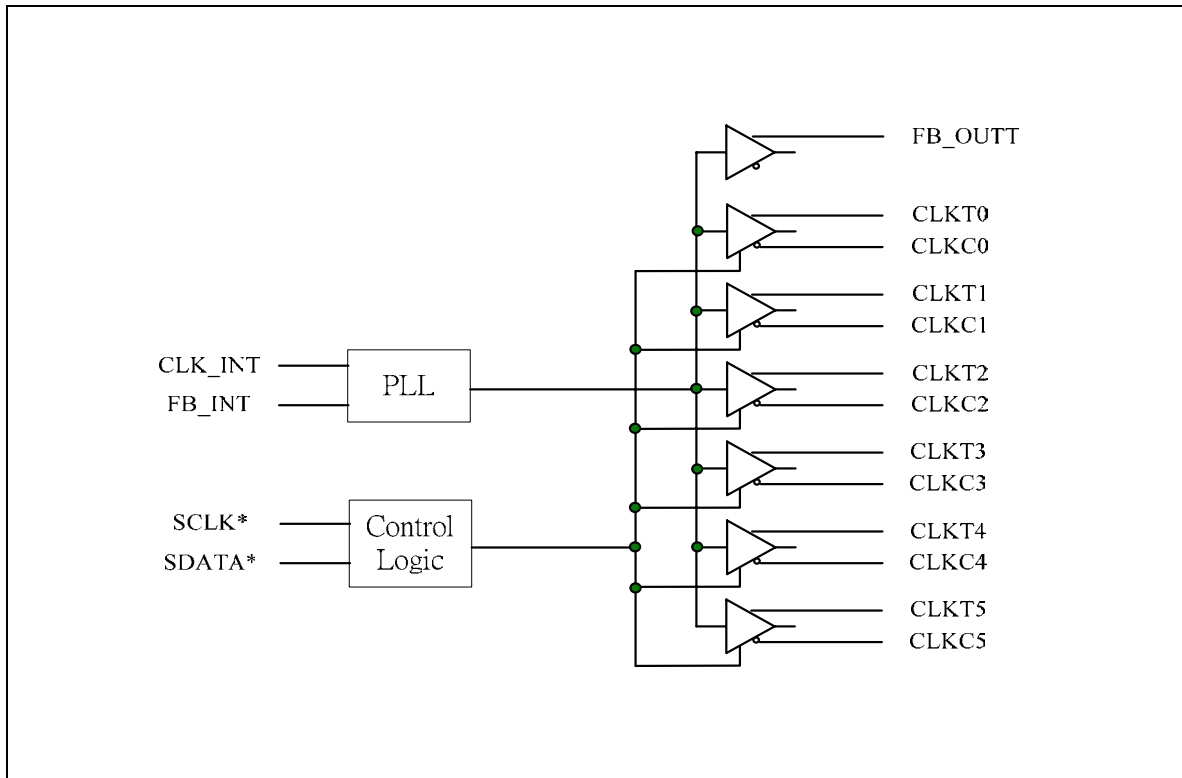

5. PIN DESCRIPTION

BUFFER TYPE SYMBOL	DESCRIPTION
IN	Input
OUT	Output
I/O	Bi-directional Pin
*	Internal 120KΩ pull-up
NC	Not connect



5.1 Clock Outputs

PIN	PIN NAME	TYPE	DESCRIPTION
27, 25, 16, 14, 5, 1	CLKC [5:0]	OUT	Complementary Clocks of differential pair outputs
26, 24, 17, 13, 4, 2	CLKT [5:0]	OUT	True Clocks of differential pair outputs
22	SDATA *	I/O	Serial data of I ² C 2-wire control interface Internal pull-up resistor 120K to VDD
7	SCLK *	IN	Serial clock of I ² C 2-wire control interface Internal pull-up resistor 120K to VDD
8	CLK_INT	IN	True reference clock input, 3.3V tolerant input
9, 18, 21	N/C	NC	Not connected
19	FB_OUTT	OUT	True Feedback output, dedicated for external feedback. It switches at the same frequency as the CLK. This output must be wired to FB_INT.
20	FB_INT	IN	True Feedback input, provides feedback signal to the internal PLL for synchronization with CLK_INT to eliminate phase error.

5.2 Power Pins

PIN	PIN NAME	DESCRIPTION
6, 11, 15, 28	GND	Ground
3, 12, 23	VDD	Power supply 2.5V
10	AVDD	Analog power supply, 2.5V



6. REGISTER 0 ~ REGISTER 4 RESERVED

6.1 Register 5: Output Control (1 = Active, 0 = Inactive) (Default = FFh)

BIT	@POWERUP	PIN	DESCRIPTION
7	1	1, 2	CLKC0, CLKT0 (Active/Inactive)
6	1	5, 4	CLKC1, CLKT1 (Active/Inactive)
5	1	-	Reserved
4	1	-	Reserved
3	1	14, 13	CLKC2, CLKT2 (Active/Inactive)
2	1	16, 17	CLKC3, CLKT3 (Active/Inactive)
1	1	-	Reserved
0	1	-	Reserved

6.2 Register 6: Output Control (1 = active, 0 = inactive) (Default = FFh)

BIT	@POWERUP	PIN	DESCRIPTION
7	1	-	Reserved
6	1	-	Reserved
5	1	-	Reserved
4	1	-	Reserved
3	1	25, 24	CLKC4, CLKT4 (Active/Inactive)
2	1	-	Reserved
1	1	27, 26	CLKC5, CLKT5 (Active/Inactive)
0	1	-	Reserved



7. ACCESS INTERFACE

The W83176R-732 provides I²C Serial Bus for microprocessor to read/write internal registers. In the W83176R-732 is provided Block Read/Block Write and Byte-Data Read/Write protocol. The I²C write address is defined at 0xD4. The I²C read address is defined at 0xD5.

7.1 Block Write Protocol

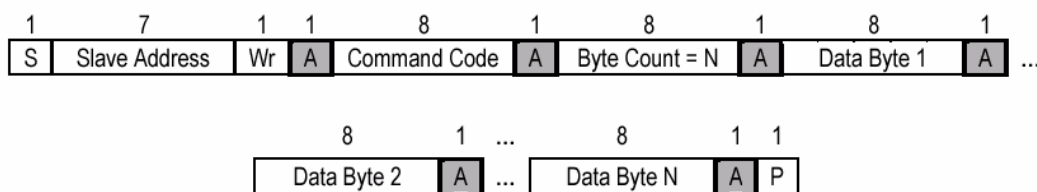

7.2 Block Read Protocol

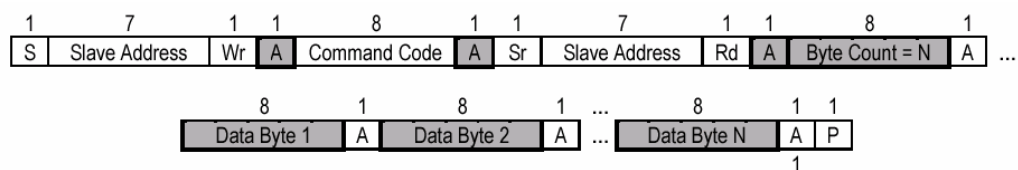

In block mode, the command code must filled '00h'

7.3 Byte Write Protocol

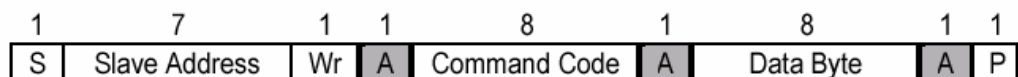

7.4 Byte Read Protocol

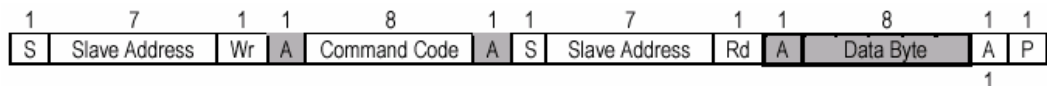



8. SPECIFICATIONS

8.1 Absolute Maximum Ratings

Stresses greater than those listed in this table may cause permanent damage to the device. Precautions should be taken to avoid application of any voltage higher than the maximum rated voltages to this circuit. Maximum conditions for extended periods may affect reliability. Unused inputs must always be tied to an appropriate logic voltage level (Ground or VDD).

SYMBOL	PARAMETER	RATING
VDD, AVDD	Voltage on any pin with respect to GND	-0.5V to +3.6V
T _{STG}	Storage Temperature	-65°C to +150°C
T _B	Ambient Temperature	-55°C to +125°C
T _A	Operating Temperature	0°C to +70°C

8.2 A.C. Characteristics

VDD = AVDD = 2.5V ±5 %, T_A = 0°C to +70°C, Test load = 10 pF

PARAMETER	SYM.	MIN.	TYP.	MAX.	UNITS	TEST CONDITIONS
Operating Clock Frequency	F _{IN}	100		200	MHz	
Input Clock Duty Cycle	D _{tin}	40		60	%	
Dynamic Supply Current	I _{dd}			300	mA	F _{in} = 100 to 200 MHz
Cycle to Cycle Jitter	C-C _{jitter}			200	pS	F _{out} = 100 to 200 MHz
Output to Output Skew	T _{skew}			100	pS	F _{out} = 100 to 200 MHz
Output Clock Rise Time	T _{or}	650		950	pS	F _{out} = 100 to 200 MHz
Output Clock Fall Time	T _{of}	650		950	pS	F _{out} = 100 to 200 MHz
Output Clock Duty Cycle	D _{tot}	45		55	%	F _{out} = 100 to 200 MHz
Output Differential-pair Crossing Voltage	V _{oc}	(VDD/2) - 0.2	VDD/2	(VDD/2) + 0.2	V	F _{out} = 100 to 200 MHz

8.3 D.C. Characteristics

VDD = AVDD = 2.5V ±5 %, T_A = 0°C to +70°C

PARAMETER	SYM.	MIN.	TYP.	MAX.	UNITS	TEST CONDITIONS
SDATA, SCLK Input Low Voltage	SV _{IL}			1.0	V _{dc}	
SDATA, SCLK Input High Voltage	SV _{IH}	2.2			V _{dc}	

W83176R-732



D.C. Characteristics, continued.

PARAMETER	SYM.	MIN.	TYP.	MAX.	UNITS	TEST CONDITIONS
CLKIN, FBIN Input Voltage Low	V _{IL}			0.4	V _{dc}	Fin = 100 to 200 MHz
CLKIN, FBIN Input Voltage High	V _{IH}	2.1			V _{dc}	Fin = 100 to 200 MHz
Input Pin Capacitance	C _{IN}			5	pF	
Output Pin Capacitance	C _{OUT}			6	pF	
Input Pin Inductance	L _{IN}			7	nH	

9. ORDERING INFORMATION

PART NUMBER	PACKAGE TYPE	PRODUCTION FLOW
W83176R_732	28-pin SSOP	Commercial, 0°C to +70°C

10. HOW TO READ THE TOP MARKING

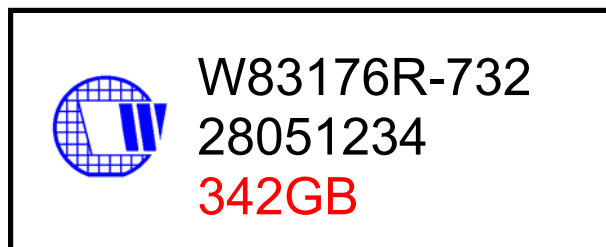

1st line: Winbond logo and the type number: W83176R-732

2nd line: Tracking code 2 8051234

2: wafers manufactured in Winbond FAB 2

8051234: wafer production series lot number

3rd line: Tracking code 342 G B

342: packages made in '2003, week 42

G: assembly house ID; O means OSE, G means GR

B: IC revision

All the trade marks of products and companies mentioned in this data sheet belong to their respective owners.

Publication Release Date: April 13, 2005

Revision 1.1



11. PACKAGE DRAWING AND DIMENSIONS

28-pin 209 mil

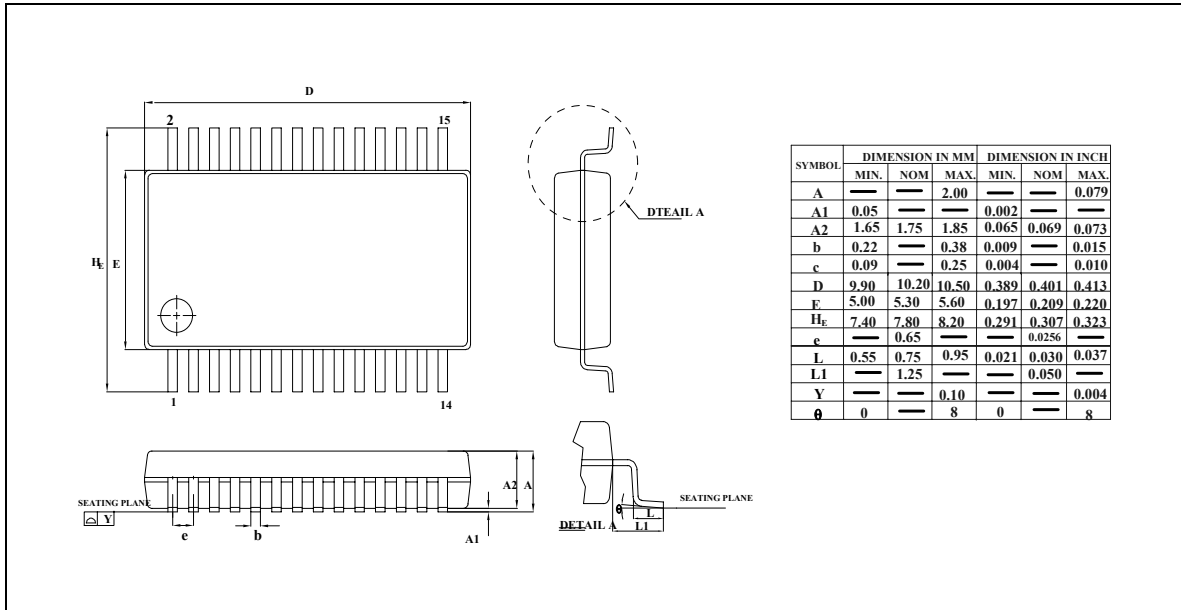



12. REVISION HISTORY

VERSION	DATE	PAGE	DESCRIPTION
			All of the versions before 0.50 are for internal use.
0.5	12/18/03	n.a.	First published preliminary version
1.0	05/06/04		Update on web
1.1	04/13/2005	9	Add disclaimer

Important Notice

Winbond products are not designed, intended, authorized or warranted for use as components in systems or equipment intended for surgical implantation, atomic energy control instruments, airplane or spaceship instruments, transportation instruments, traffic signal instruments, combustion control instruments, or for other applications intended to support or sustain life. Further more, Winbond products are not intended for applications wherein failure of Winbond products could result or lead to a situation wherein personal injury, death or severe property or environmental damage could occur.

Winbond customers using or selling these products for use in such applications do so at their own risk and agree to fully indemnify Winbond for any damages resulting from such improper use or sales.



Headquarters

No. 4, Creation Rd. III,
Science-Based Industrial Park,
Hsinchu, Taiwan
TEL: 886-3-5770066
FAX: 886-3-5665577
<http://www.winbond.com.tw/>

Taipei Office

9F, No.480, Rueiguang Rd.,
Neihu District, Taipei, 114,
Taiwan, R.O.C.
TEL: 886-2-8177-7168
FAX: 886-2-8751-3579

Winbond Electronics Corporation America

2727 North First Street, San Jose,
CA 95134, U.S.A.
TEL: 1-408-9436666
FAX: 1-408-5441798

Winbond Electronics Corporation Japan

7F Daini-ueno BLDG, 3-7-18
Shinyokohama Kohoku-ku,
Yokohama, 222-0033
TEL: 81-45-4781881
FAX: 81-45-4781800

Winbond Electronics (Shanghai) Ltd.

27F, 2299 Yan An W. Rd. Shanghai,
200336 China
TEL: 86-21-62365999
FAX: 86-21-62365998

Winbond Electronics (H.K.) Ltd.

Unit 9-15, 22F, Millennium City,
No. 378 Kwun Tong Rd.,
Kowloon, Hong Kong
TEL: 852-27513100
FAX: 852-27552064

*Please note that all data and specifications are subject to change without notice.
All the trade marks of products and companies mentioned in this data sheet belong to their respective owners.*