



W83176R-732

W83176G-732

**Winbond 2 DIMM DDR ZERO DELAY
BUFFER**

Date: March/22/2006 Revision: 1.1

W83176R-732/W83176G-732



W83176R-732/W83176G-732 Data Sheet Revision History

	PAGES	DATES	VERSION	WEB VERSION	MAIN CONTENTS
1	n.a.	12/18/03	0.5	n.a.	First published preliminary version
2		12/15/04	1.0	1.0	Publish on Website
3		03/22/2006	1.1	1.1	Add lead free part
4					
5					
6					
7					
8					
9					
10					

Please note that all data and specifications are subject to change without notice. All the trademarks of products and companies mentioned in this data sheet belong to their respective owners.

LIFE SUPPORT APPLICATIONS

These products are not designed for use in life support appliances, devices, or systems where malfunction of these products can reasonably be expected to result in personal injury. Winbond customers using or selling these products for use in such applications do so at their own risk and agree to fully indemnify Winbond for any damages resulting from such improper use or sales.

W83176R-732/W83176G-732



Table of Content-

1.	GENERAL DESCRIPTION	1
2.	PRODUCT FEATURES	1
3.	PIN CONFIGURATION	1
4.	BLOCK DIAGRAM	2
5.	PIN DESCRIPTION.....	2
5.1	Clock Outputs	2
5.2	Power Pins.....	3
6.	REGISTER 0 ~ REGISTER 4 RESERVED	3
6.1	Register 5: Output Control (1 = Active, 0 = Inactive) (Default =FFh).....	3
6.2	Register 6: Output Control (1 = active, 0 = inactive) (Default =FFh)	3
7.	ACCESS INTERFACE	4
7.1	Block Write protocol	4
7.2	Block Read protocol	4
7.3	Byte Write protocol	4
7.4	Byte Read protocol.....	4
8.	SPECIFICATIONS	5
8.1	ABSOLUTE MAXIMUM RATINGS	5
8.2	AC CHARACTERISTICS.....	5
8.3	DC CHARACTERISTICS	6
9.	ORDERING INFORMATION.....	7
10.	HOW TO READ THE TOP MARKING	7
11.	PACKAGE DRAWING AND DIMENSIONS.....	8

W83176R-732/W83176G-732



1. GENERAL DESCRIPTION

The W83176R-732 is a 2.5V Zero-delay D.D.R. Clock buffer designed for SiS chipset. W83176R-732 can support 2 D.D.R. DRAM DIMMs.

The W83176R-732 provides I²C serial bus interface to program the registers to enable or disable each clock outputs. The W83176R-732 accepts a reference clock as its input and runs on 2.5V supply.

2. PRODUCT FEATURES

- Zero-delay clock outputs
- Feedback pins for synchronous
- Supports up to 2 D.D.R. DIMMs
- One pairs of additional outputs for feedback
- Low Skew outputs (< 100ps)
- Supports 400MHz D.D.R. SDRAM
- I²C 2-Wire serial interface and supports Byte or Block Date RW
- 28-pin SSOP package

3. PIN CONFIGURATION

CLKC0	1 ●	28	GND
CLKT0	2	27	CLKC5
VDD	3	26	CLKT5
CLKT1	4	25	CLKC4
CLKC1	5	24	CLKT4
GND	6	23	VDD
SCLK*	7	22	SDATA*
CLK_INT	8	21	NC
NC	9	20	FB_INT
AVDD	10	19	FB_OUT1
GND	11	18	NC
VDD	12	17	CLKT3
CLKT2	13	16	CLKC3
CLKC2	14	15	GND

*: Internal pull-up resistor 120K to VDD

W83176R-732/W83176G-732



4. BLOCK DIAGRAM

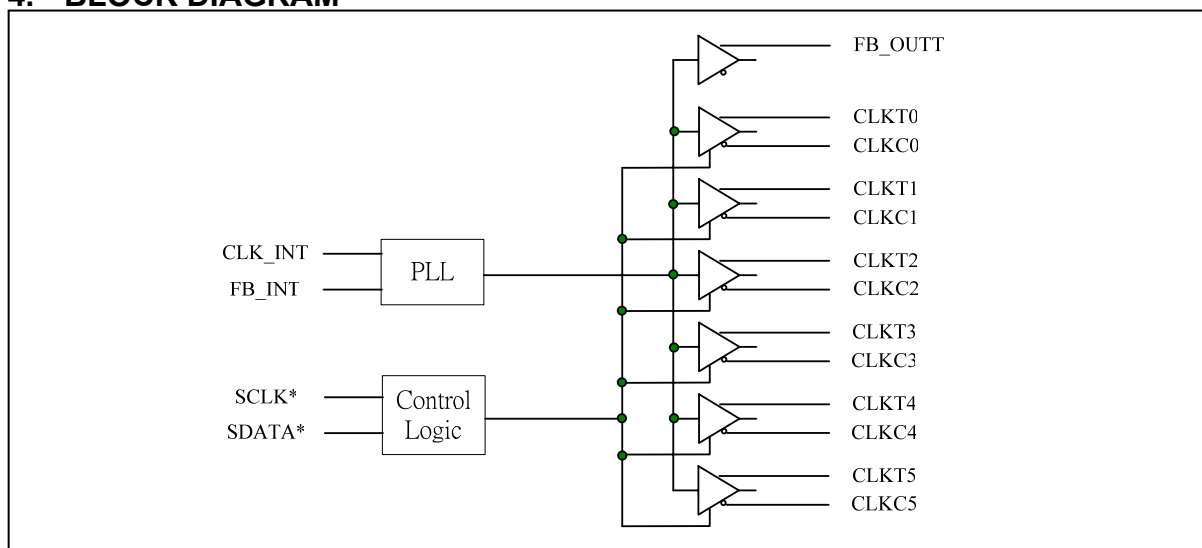

5. PIN DESCRIPTION

BUFFER TYPE SYMBOL	DESCRIPTION
IN	Input
OUT	Output
I/O	Bi-directional Pin
*	Internal 120kΩ pull-up
NC	Not connect

5.1 Clock Outputs

PIN	PIN NAME	TYPE	DESCRIPTION
27,25,16,14,5,1	CLKC [5:0]	OUT	Complementary Clocks of differential pair outputs
26,24,17,13,4,2	CLKT [5:0]	OUT	True Clocks of differential pair outputs
22	SDATA *	I/O	Serial data of I ² C 2-wire control interface Internal pull-up resistor 120K to Vdd
7	SCLK *	IN	Serial clock of I ² C 2-wire control interface Internal pull-up resistor 120K to Vdd
8	CLK_INT	IN	True reference clock input, 3.3V tolerant input
9,18,21	N/C	NC	Not connected
19	FB_OUTT	OUT	True Feedback output, dedicated for external feedback. It switches at the same frequency as the CLK. This output must be wired to FB_INT.
20	FB_INT	IN	True Feedback input, provides feedback signal to the internal PLL for synchronization with CLK_INT to eliminate phase error.

W83176R-732/W83176G-732



2 DIMM DDR ZERO DELAY buffer for Sis chipset

5.2 Power Pins

PIN	PIN NAME	DESCRIPTION
6,11,15,28	GND	Ground
3,12,23	VDD	Power Supply 2.5V
10	AVDD	Analog power supply, 2.5V

6. REGISTER 0 ~ REGISTER 4 RESERVED

6.1 Register 5: Output Control (1 = Active, 0 = Inactive) (Default =FFh)

BIT	@POWERUP	PIN	DESCRIPTION
7	1	1,2	CLKC0, CLKT0 (Active / Inactive)
6	1	5,4	CLKC1, CLKT1 (Active / Inactive)
5	1	-	Reserved
4	1	-	Reserved
3	1	14,13	CLKC2, CLKT2 (Active / Inactive)
2	1	16,17	CLKC3, CLKT3 (Active / Inactive)
1	1	-	Reserved
0	1	-	Reserved

6.2 Register 6: Output Control (1 = active, 0 = inactive) (Default =FFh)

BIT	@POWERUP	PIN	DESCRIPTION
7	1	-	Reserved
6	1	-	Reserved
5	1	-	Reserved
4	1	-	Reserved
3	1	25,24	CLKC4, CLKT4 (Active / Inactive)
2	1	-	Reserved
1	1	27,26	CLKC5, CLKT5 (Active / Inactive)
0	1	-	Reserved

W83176R-732/W83176G-732



7. ACCESS INTERFACE

The W83176R-732 provides I²C Serial Bus for microprocessor to read/write internal registers. In the W83176R-732 is provided Block Read/Block Write and Byte-Data Read/Write protocol. The I²C write address is defined at 0xD4. The I²C read address is defined at 0xD5.

7.1 Block Write protocol

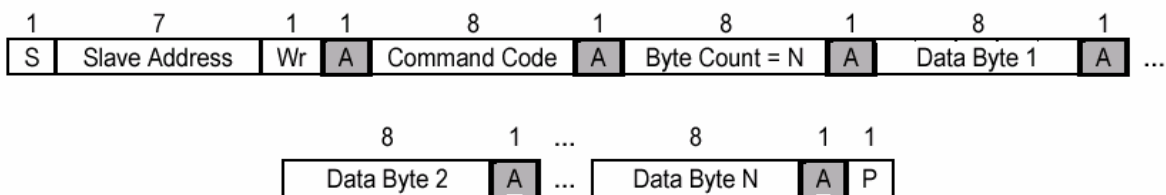

7.2 Block Read protocol

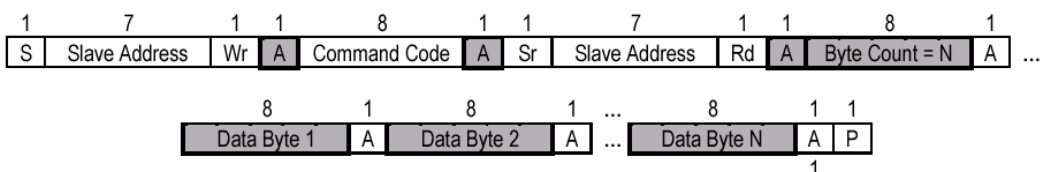

In block mode, the command code must filled '00h'

7.3 Byte Write protocol

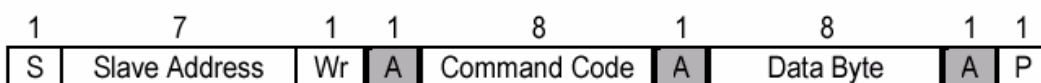

7.4 Byte Read protocol

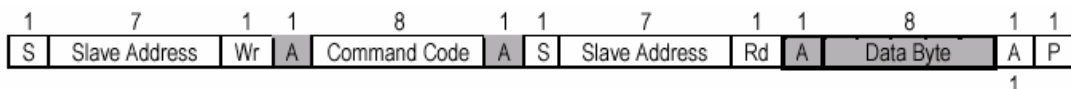

W83176R-732/W83176G-732



8. SPECIFICATIONS

8.1 ABSOLUTE MAXIMUM RATINGS

Stresses greater than those listed in this table may cause permanent damage to the device. Precautions should be taken to avoid application of any voltage higher than the maximum rated voltages to this circuit. Maximum conditions for extended periods may affect reliability. Unused inputs must always be tied to an appropriate logic voltage level (Ground or VDD).

SYMBOL	PARAMETER	RATING
VDD, AVDD	Voltage on any pin with respect to GND	- 0.5 V to + 3.6 V
T _{STG}	Storage Temperature	- 65°C to + 150°C
T _B	Ambient Temperature	- 55°C to + 125°C
T _A	Operating Temperature	0°C to + 70°C

8.2 AC CHARACTERISTICS

VDD = AVDD = 2.5V ± 5 %, T_A = 0°C to +70°C, Test load = 10 pF						
PARAMETER	SYMBOL	MIN	TYP	MAX	UNIT S	TEST CONDITIONS
Operating clock frequency	F _{IN}	100		200	MHz	
Input Clock Duty Cycle	D _{tin}	40		60	%	
Dynamic Supply Current	I _{dd}			300	mA	F _{in} =100 to 200Mhz
Cycle to Cycle Jitter	C-Cjitter			200	ps	F _{out} =100 to 200Mhz
Output to Output Skew	T _{skew}			100	ps	F _{out} =100 to 200Mhz
Output clock Rise time	T _{or}	650		950	ps	F _{out} =100 to 200Mhz
Output clock Fall time	T _{of}	650		950	ps	F _{out} =100 to 200Mhz
Output clock Duty Cycle	D _{tot}	45		55	%	F _{out} =100 to 200Mhz
Output differential-pair crossing voltag	V _{oc}	(V _{dd} /2) -0.2	V _{dd} /2	(V _{dd} /2) + 0.2	V	F _{out} =100 to 200Mhz

W83176R-732/W83176G-732



8.3 DC CHARACTERISTICS

$V_{dd} = AV_{DD} = 2.5V \pm 5\%$, $T_A = 0^{\circ}C$ to $+70^{\circ}C$						
PARAMETER	SYMBOL	MIN	TYP	MAX	UNITS	TEST CONDITIONS
SDATA, SCLK Input Low Voltage	SV_{IL}			1.0	V_{dc}	
SDATA, SCLK Input High Voltage	SV_{IH}	2.2			V_{dc}	
CLKIN, FBIN Input Voltage Low	V_{IL}			0.4	V_{dc}	Fin=100 to 200Mhz
$V_{dd} = AV_{DD} = 2.5V \pm 5\%$, $T_A = 0^{\circ}C$ to $+70^{\circ}C$						
PARAMETER	SYMBOL	MIN	TYP	MAX	UNITS	TEST CONDITIONS
CLKIN, FBIN Input Voltage High	V_{IH}	2.1			V_{dc}	Fin=100 to 200Mhz
Input Pin Capacitance	C_{IN}			5	pF	
Output Pin Capacitance	C_{OUT}			6	pF	
Input Pin Inductance	L_{IN}			7	nH	

W83176R-732/W83176G-732



9. ORDERING INFORMATION

Part Number	Package Type	Production Flow
W83176R-732	28 PIN SSOP	Commercial, 0°C to +70°C
W83176G-732	28 PIN SSOP (Lead free package)	Commercial, 0°C to +70°C

10. HOW TO READ THE TOP MARKING

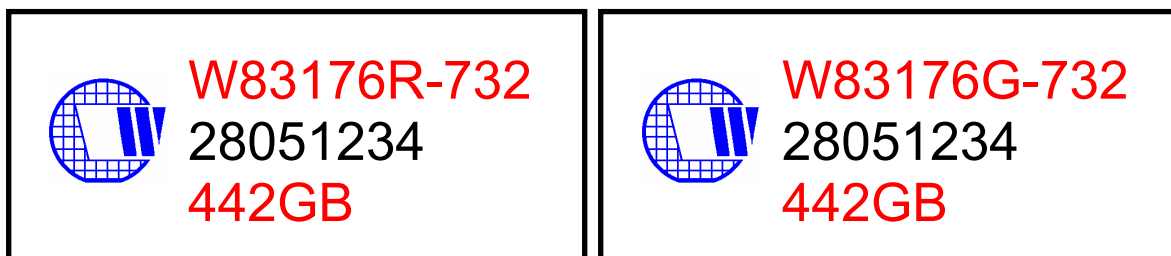

1st line: Winbond logo and the type number:

Normal package: W83176R-732, Lead free package:W83176G-732

2nd line: Tracking code 2 8051234

2: wafers manufactured in Winbond FAB 2

8051234: wafer production series lot number

3rd line: Tracking code 342 G B

442: packages made in '2003, week 42

G: assembly house ID; O means OSE, G means GR

B: IC revision

All the trade marks of products and companies mentioned in this data sheet belong to their respective owners.

W83176R-732/W83176G-732



11. PACKAGE DRAWING AND DIMENSIONS

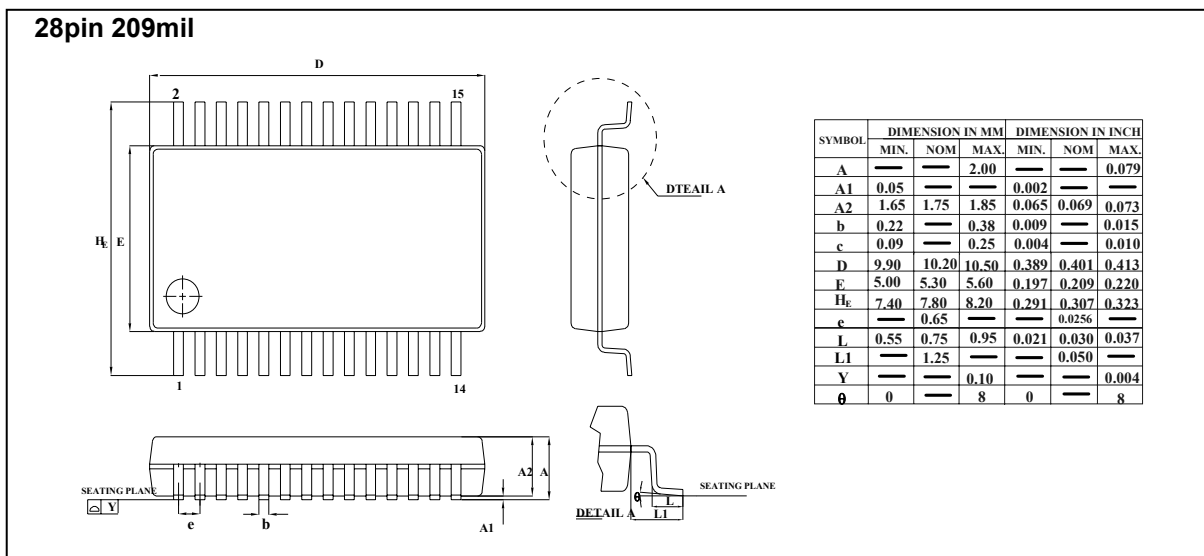

Please note that all data and specifications are subject to change without notice. All the trade marks of products and companies mentioned in this data sheet belong to their respective owners.

W83176R-732/W83176G-732



Important Notice

Winbond products are not designed, intended, authorized or warranted for use as components in systems or equipment intended for surgical implantation, atomic energy control instruments, airplane or spaceship instruments, transportation instruments, traffic signal instruments, combustion control instruments, or for other applications intended to support or sustain life. Further more, Winbond products are not intended for applications wherein failure of Winbond products could result or lead to a situation wherein personal injury, death or severe property or environmental damage could occur.

Winbond customers using or selling these products for use in such applications do so at their own risk and agree to fully indemnify Winbond for any damages resulting from such improper use or sales.

*Please note that all data and specifications are subject to change without notice.
All the trademarks of products and companies mentioned in this datasheet belong to their respective owners.*