

W83194BR-911

W83194BG-911

**Winbond STEPLESS VIA PT/PM
MAIN CLOCK GENERATOR**

Date: Mar/22/2006 Revision: 0.71

STEPLESS CLOCK FOR VIA PT/PM CHIPSET

W83194BR-911/W83195BG-911 Data Sheet Revision History

	PAGES	DATES	VERSION	WEB VERSION	MAIN CONTENTS
1					All of the versions before 0.50 are for internal use.
2	n.a.	08/28/03	0.5	n.a.	First published preliminary version.
3	6	10/28/03	0.6	n.a.	Modify frequency table
4	7,8,9,19	12/18/03	0.7	n.a.	Correction IC version, correction some description and default value
5		12/05/05	0.71	n.a.	Add Pb-free part no:W83194BG-911
6					
7					
8					
9					
10					

Please note that all data and specifications are subject to change without notice. All the trademarks of products and companies mentioned in this data sheet belong to their respective owners.

LIFE SUPPORT APPLICATIONS

These products are not designed for use in life support appliances, devices, or systems where malfunction of these products can reasonably be expected to result in personal injury. Winbond customers using or selling these products for use in such applications do so at their own risk and agree to fully indemnify Winbond for any damages resulting from such improper use or sales.

STEPLESS CLOCK FOR VIA PT/PM CHIPSET

Table of Content-

1.	GENERAL DESCRIPTION	1
2.	PRODUCT FEATURES	1
3.	PIN CONFIGURATION.....	2
4.	BLOCK DIAGRAM	2
5.	PIN DESCRIPTION	3
5.1	Crystal I/O.....	3
5.2	CPU, AGP, and PCI Clock Outputs.....	3
5.3	Fixed Frequency Outputs.....	4
5.4	I ² C Control Interface	4
5.5	Power Management Pins.....	5
5.6	IREF selects Function	5
5.7	Power Pins	5
6.	FREQUENCY SELECTION BY HARDWARE OR SOFTWARE.....	6
7.	I ² C CONTROL AND STATUS REGISTERS.....	7
7.1	Register 0: Frequency Select (Default = 10h).....	7
7.2	Register 1: CPU Clock (1 = Enable, 0 = Stopped) (Default: E2h).....	7
7.3	Register 2: PCI Clock (1 = Enable, 0 = Stopped) (Default: FFh).....	7
7.4	Register 3: PCI, AGP Clock (1 = Enable, 0 = Stopped) (Default: FFh).....	8
7.5	Register 4: 24_48MHz, 48MHz, REF, 25MHz Control (1 = Enable, 0 = Stopped) (Default: BFh)..	8
7.6	Register 5: Watchdog Control (Default: 02h)	9
7.7	Register 6: Reserved (Default: 50h) (Read Only).....	9
7.8	Register 7: Winbond Chip ID (Default: 70h) (Read Only).....	10
7.9	Register 8: M/N Program (Default: 90h).....	10
7.10	Register 9: M/N Program (Default: 7Ah)	10
7.11	Register 10: M/N Program (Default: BBh).....	11
7.12	Register 11: Spread Spectrum Programming (Default: 0Bh)	11
7.13	Register 12: Divisor and Step-less Enable Control (Default: FBh).....	11
7.14	Table-2 CPU, AGP, PCI divider ratio selection Table.....	12
7.15	Register 13: Divisor and Step-less Enable Control (Default: 0Fh)	12
7.16	Register 14: Control (Default: 0Ah).....	12
7.17	Register 15: SST & Skew Control (Default: 2Ch)	13
7.18	Register 16: Skew Control (Default: 24h).....	13
7.19	Register 17: Slew rate Control (Default: 00h).....	13
7.20	Register 18: Slew rate Control (Default: 00h).....	14
7.21	Register 19: Slew Rate Control (Default: D2h)	14
7.22	Register 20: Watch dog timer (Default: 08h).....	14
7.23	Register 21: Fix mode Control (Default: 00h).....	15

STEPLESS CLOCK FOR VIA PT/PM CHIPSET

8.	ACCESS INTERFACE.....	16
8.1	Block Write protocol	16
8.2	Block Read protocol	16
8.3	Byte Write protocol	16
8.4	Byte Read protocol.....	16
9.	SPECIFICATIONS	17
9.1	ABSOLUTE MAXIMUM RATINGS	17
9.2	General Operating Characteristics	17
9.3	Skew Group timing clock	17
9.4	CPU 0.7V Electrical Characteristics	18
9.5	AGP Electrical Characteristics	18
9.6	PCI Electrical Characteristics.....	18
9.7	24M, 48M Electrical Characteristics	19
9.8	REF Electrical Characteristics	19
10.	ORDERING INFORMATION	20
11.	HOW TO READ THE TOP MARKING	20
12.	PACKAGE DRAWING AND DIMENSIONS	21

STEPLESS CLOCK FOR VIA PT/PM CHIPSET

1. GENERAL DESCRIPTION

The W83194BR-911 is a Clock Synthesizer for VIA PT880/PM880 chipset. W83194BR-911 provides all clocks required for high-speed microprocessor and provides step-less frequency programming and 32 different frequencies of CPU, PCI, and AGP clocks setting, support two 25MHz clock outputs, all clocks are externally selectable with smooth transitions.

The W83194BR-911 provides I²C serial bus interface to program the registers to enable or disable each clock outputs and provides -0.5% and +/-0.25% center type spread spectrum or programmable S.S.T. scale to reduce EMI.

The W83194BR-911 also has watchdog timer and reset output pin to support auto-reset when systems hanging caused by improper frequency setting.

The W83194BR-911 accepts a 14.318 MHz reference crystal as its input and runs on a 3.3V supply.

2. PRODUCT FEATURES

- 2 0.7V current-mode Differential pairs clock outputs
- 2 2.5V 25MHz clock outputs
- 3 AGP clock outputs
- 10 PCI synchronous clocks
- 1 24_48Mhz clock output for super I/O.
- 1 48 MHz clock output for USB.
- 3 14.318MHz REF clock outputs.
- AGP/PCI clock out supports synchronous and asynchronous mode
- Smooth frequency switch with selections from 100 to 400MHz
- Step-less frequency programming
- I²C 2-Wire serial interface and support byte read/write and block read/write.
- -0.5% and +/- 0.25% center type spread spectrum
- Programmable S.S.T. scale to reduce EMI
- Programmable registers to enable/stop each output and select modes
- Programmable clock outputs Slew rate control and Skew control
- Watch Dog Timer and RESET# output pins
- 48-pin SSOP package

STEPLESS CLOCK FOR VIA PT/PM CHIPSET

3. PIN CONFIGURATION

FS1*REF0	1	48	VDDA
FS0*REF1	2	47	GND
REF2	3	46	IREF
VDDREF	4	45	RESE#
XIN	5	44	GND
XOUT	6	43	CPCLKI1
GND	7	42	CPCLKI
FS2*FCI_F0	8	41	VDDFU
FS4*FCI_F1	9	40	CPCLKI0
FCI_F2	10	39	CPCLKI0
VDDFCI	11	38	GND
GND	12	37	25MHz_0
MODE*FCI	13	36	25MHz_1
FCI	14	35	VEE5
FC2	15	34	VTT_PVRGDED#*
FC3	16	33	SDATA*
FC4	17	32	SCLK*
VDDFCI	18	31	AGP_0
GND	19	30	AGP_1
FCI_STOR#* AC5	20	29	GND
FCU_STOR#* AC6	21	28	VDDAP
VDDFCI	22	27	AGP_2
FS3*48MHz	23	26	VDD6
SEL24_48#* &24_48MHz	24	25	GND

#: Active low

*: Internal pull up resistor 120K to VDD

&: Internal Pull-down resistor 120K to GND

4. BLOCK DIAGRAM

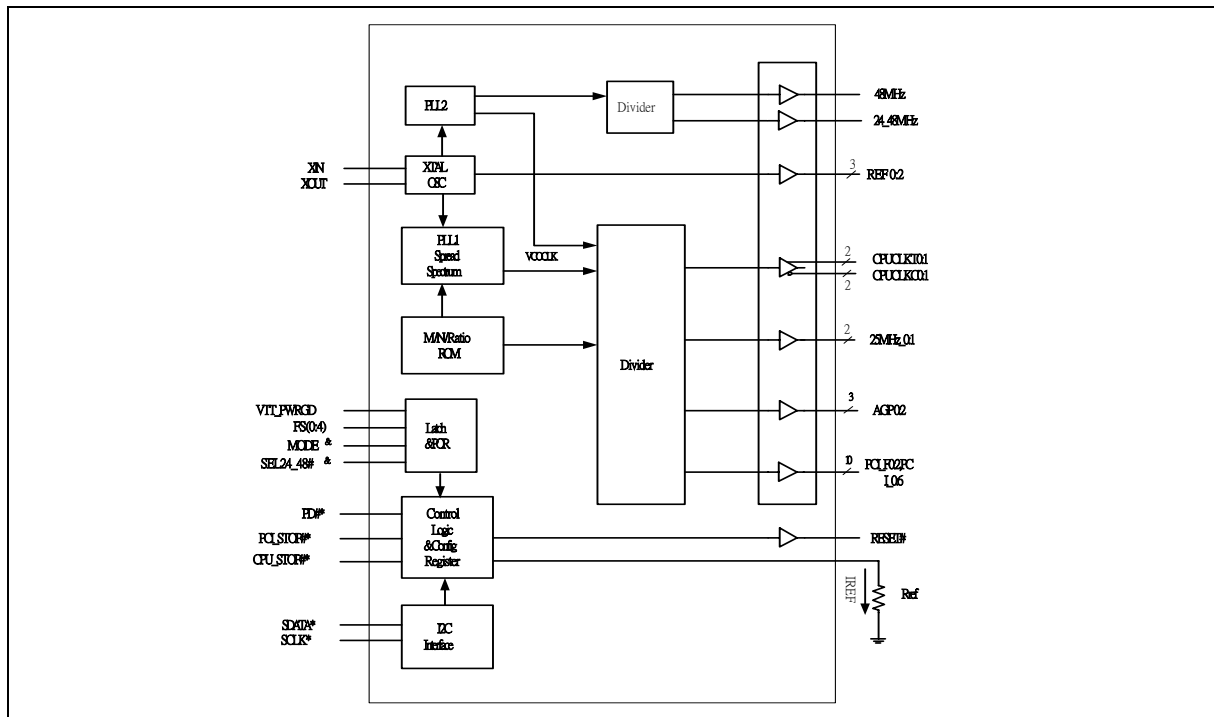

STEPLESS CLOCK FOR VIA PT/PM CHIPSET

5. PIN DESCRIPTION

BUFFER TYPE SYMBOL	DESCRIPTION
IN	Input
IN _{tp120k}	Latched input at power up, internal 120kΩ pull up.
IN _{td120k}	Latched input at power up, internal 120kΩ pull down.
OUT	Output
OD	Open Drain
I/O	Bi-directional Pin
I/OD	Bi-directional Pin, Open Drain.
#	Active Low
*	Internal 120kΩ pull-up
&	Internal 120 kΩ pull-down

5.1 Crystal I/O

PIN	PIN NAME	TYPE	DESCRIPTION
5	XIN	IN	Crystal input with internal loading capacitors (18pF) and feedback resistors.
6	XOUT	OUT	Crystal output at 14.318MHz nominally with internal loading capacitors (18pF).

5.2 CPU, AGP, and PCI Clock Outputs

PIN	PIN NAME	TYPE	DESCRIPTION
43,40,42,39	CPUCLKT [0:1] CPUCLKC [0:1]	OUT	Low skew (< 250ps) differential clock outputs for host frequencies of CPU
31,30,27	AGP0: 2	OUT	3.3V AGP clock outputs.
8	PCI_F0	OUT	3.3V PCI free running clock output.
	FS2 ^{&}	IN _{td120k}	Latched input for FS2 at initial power up for H/W selecting the output frequency. This is internal 120K pull down.
9	PCI_F1	OUT	3.3V PCI free running clock output.
	FS4 ^{&}	IN _{td120k}	Latched input for FS4 at initial power up for H/W selecting the output frequency, This is internal 120K pull down.
13	PCI0	OUT	3.3V PCI clock output.
	MODE ^{&}	IN _{td120k}	Latched input for pin 20,21 at initial power up selecting the 0=PCI5, PCI6 clock output, 1=PCI_STOP and CPU_STOP control pin. This is internal 120KΩ pull down.
	PCI_F2	OUT	3.3V PCI free running clock output.

STEPLESS CLOCK FOR VIA PT/PM CHIPSET

CPU, AGP, and PCI Clock Outputs, continued

PIN	PIN NAME	TYPE	DESCRIPTION
14,15,16,17	PCI [1:4]	OUT	Low skew (< 250ps) PCI clock outputs.
20	PCI5	OUT	3.3V PCI clock output.
	PCI_STOP#*	IN _{tp120k}	Active low, Stop all PCI clock output besides the free running clocks.
21	PCI6	OUT	3.3V PCI clock output.
	CPU_STOP#*	IN _{tp120k}	Active low, Stop all CPU clock outputs.

5.3 Fixed Frequency Outputs

PIN	PIN NAME	TYPE	DESCRIPTION
1	REF0	OUT	14.318MHz output.
	FS1*	IN _{tp120k}	Latched input for FS1 at initial power up for H/W selecting the output frequency. This is internal 120K pull up.
2	REF1	OUT	14.318MHz output.
	FS0 ^{&}	IN _{td120k}	Latched input for FS0 at initial power up for H/W selecting the output frequency. This is internal 120K pull down.
3	REF2	OUT	14.318MHz output.
23	48MHz	OUT	48MHz clock output for USB.
	FS3 ^{&}	IN _{td120k}	Latched input for FS3 at initial power up for H/W selecting the output frequency. This is internal 120K pull down.
24	24_48MHz	OUT	24MHz or 48MHz(default) clock output, In power on reset period, it is a hardware-latched pin, and it can be R/W by I2C control after power on reset period. Select by register 5 bit 7.
	SEL24_48# ^{&}	IN _{td120k}	Latched input for 24MHz or 48MHz select pin. This is internal 120K pull down default 48MHz. In power on reset period, it is a hardware-latched pin, and it can be R/W by I2C control after power on reset period. Select by register 5 bit 7.
37,36	25MHz_[0:1]	OUT	25MHz 2.5V push pull clock output.

5.4 I²C Control Interface

PIN	PIN NAME	TYPE	DESCRIPTION
33	SDATA*	I/OD	Serial data of I ² C 2-wire control interface with internal pull-up resistor.
32	SCLK*	IN	Serial clock of I ² C 2-wire control interface with internal pull-up resistor.

STEPLESS CLOCK FOR VIA PT/PM CHIPSET

5.5 Power Management Pins

PIN	PIN NAME	TYPE	DESCRIPTION
34	VTT_PWRGD	IN	Power good input signal is power on trapping with HIGH active. This 3.3V input is level sensitive strobe used to determine FS [4:0]. This pin is HIGH active.
	PD#*	IN _{tp120k}	Power Down Function. This is power down pin, low active (PD#). Internal 120K pull up
46	IREF	OUT	Deciding the reference current for the CPUCLK pairs. The pin was connected to the precision resistor tied to ground to decide the appropriate current.
45	RESET#	OD	System reset signal when the watchdog is time out. This pin will generate 250ms low phase when the watchdog timer is timeout.

5.6 IREF selects Function

BOARD TARGET TRACE/TERM Z	REFERENCE R, IREF = ADD/(3*RR)	OUTPUT CURRENT	VOH @ Z
50 Ω	Rr =221 1% IREF = 5.00mA	Ioh=4*IREF	1.0V @ 50
50 Ω	Rr =475 1% IREF = 2.32mA	Ioh=6*IREF	0.7V @ 50

5.7 Power Pins

PIN	PIN NAME	TYPE	DESCRIPTION
4	VDDREF	PWR	3.3V power supply for REF.
11,18,22	VDDPCI	PWR	3.3V power supply for PCI.
28	VDDAGP	PWR	3.3V power supply for AGP.
41	VDDCPU	PWR	3.3V power supply for CPU.
26	VDD48	PWR	3.3 power supply for 48MHz.
35	VDD2.5	PWR	2.5V power supply for 25MHz.
48	VDDA	PWR	3.3V power for Analog power
7,12,19,25,29,38,44,47	GND	PWR	Ground pin

STEPLESS CLOCK FOR VIA PT/PM CHIPSET

6. FREQUENCY SELECTION BY HARDWARE OR SOFTWARE

This frequency table is used at power on latched FS [4:0] value or software programming at SSEL [4:0] (Register 0 bit 7 ~ 3).

FS4	FS3	FS2	FS1	FS0	CPU (MHZ)	3V66 (MHZ)	PCI (MHZ)
0	0	0	0	0	100.00	66.67	33.33
0	0	0	0	1	200.01	66.67	33.33
0	0	0	1	0	133.34	66.67	33.33
0	0	1	0	0	200.01	66.67	33.33
0	0	1	0	1	400.01	66.67	33.33
0	0	1	1	0	266.68	66.67	33.33
0	1	0	0	0	101.1	67.34	33.67
0	1	0	0	1	202.2	67.34	33.67
0	1	0	1	0	134.68	67.34	33.67
1	0	0	0	0	100.00	66.67	33.33
1	0	0	0	1	200.01	66.67	33.33
1	0	0	1	0	133.34	66.67	33.33
1	0	1	0	0	200.01	66.67	33.33
1	0	1	0	1	400.01	66.67	33.33
1	0	1	1	0	266.68	66.67	33.33
1	1	0	0	0	105.04	70.02	35.01
1	1	0	0	1	210.07	70.02	35.01
1	1	0	1	0	140.05	70.02	35.01

STEPLESS CLOCK FOR VIA PT/PM CHIPSET

7. I²C CONTROL AND STATUS REGISTERS

7.1 Register 0: Frequency Select (Default = 10h)

BIT	NAME	PWD	DESCRIPTION
7	SSEL [4]	0	Frequency selection by software via I ² C
6	SSEL [3]	0	
5	SSEL [2]	0	
4	SSEL [1]	1	
3	SSEL [0]	0	
2	EN_SSEL	0	Enable software program FS [4:0]. 0 = Select frequency by hardware. 1 = Select frequency by software I ² C - Bit 7~ 3.
1	EN_SPSP	0	Enable Spread Spectrum in the frequency table. 0 = Normal 1 = Spread Spectrum enabled
0	EN_SAFE_FREQ	0	Enable reload safe frequency when the watchdog is timeout. 0 = reload the FS [4:0] latched pins when watchdog time out. 1 = reload the safe frequency bit defined at Register 5 bit 4~0.

7.2 Register 1: CPU Clock (1 = Enable, 0 = Stopped) (Default: E2h)

BIT	PIN NO	PWD	DESCRIPTION
7	-	1	Reserved
6	43,42	1	CPUCLKT1 / C1 output control
5	40,39	1	CPUCLKT0 / C0 output control
4	-	X	Power on latched value of FS4 pin. Default: 0 (Read only)
3	-	X	Power on latched value of FS3 pin. Default: 0 (Read only)
2	-	X	Power on latched value of FS2 pin. Default: 0 (Read only)
1	-	X	Power on latched value of FS1 pin. Default: 1 (Read only)
0	-	X	Power on latched value of FS0 pin. Default: 0 (Read only)

7.3 Register 2: PCI Clock (1 = Enable, 0 = Stopped) (Default: FFh)

BIT	PIN NO	PWD	DESCRIPTION
7	10	1	PCI_F2 output control
6	9	1	PCI_F1 output control
5	8	1	PCI_F0 output control
4	Reserve	1	Reserved

STEPLESS CLOCK FOR VIA PT/PM CHIPSET

Register 2: PCI Clock (1 = Enable, 0 = Stopped) (Default: FFh), continued

BIT	PIN NO	PWD	DESCRIPTION
3	21	1	PCI6 output control
2	20	1	PCI5 output control
1	17	1	PCI4 output control
0	16	1	PCI3 output control

7.4 Register 3: PCI, AGP Clock (1 = Enable, 0 = Stopped) (Default: FFh)

BIT	PIN NO	PWD	DESCRIPTION
7	15	1	PCI2 output control
6	14	1	PCI1 output control
5	13	1	PCI0 output control
4	-	1	Don't modify it
3	-	1	Don't modify it
2	27	1	AGP_2 output control
1	30	1	AGP_1 output control
0	31	1	AGP_0 output control

7.5 Register 4: 24_48MHz, 48MHz, REF, 25MHz Control (1 = Enable, 0 = Stopped) (Default: BFh)

BIT	PIN NO	PWD	DESCRIPTION
7	24	1	24_48MHz output control
6	-	0	Reserved
5	23	1	48MHz output control
4	3	1	REF2 output control
3	2	1	REF1 output control
2	1	1	REF0 output control
1	36	1	25MHz_1 output control
0	37	1	25MHz_0 output control

STEPLESS CLOCK FOR VIA PT/PM CHIPSET

7.6 Register 5: Watchdog Control (Default: 02h)

BIT	NAME	PWD	DESCRIPTION
7	SEL24	X	24 / 48 MHz output selection, 1: 24 MHz.0: 48 MHz. (Default) Default value follow hardware trapping data on SEL24_48# pin.
6	EN_WD	0	Program this bit => 1: Enable Watchdog Timer feature. 0: Disable Watchdog Timer feature. Read-back this bit => During timer count down the bit read back to 1. If count to zero, this bit read back to 0.
5	WD_TIMEOUT	0	Read Back only. Timeout Flag. 1: Watchdog has ever started and counts to zero. 0: Watchdog is restarted and counting.
4	SAF_FREQ [4]	0	These bits will be reloaded in Reg-0 to select frequency table. As the watchdog is timeout and EN_SAFE_FREQ=1.
3	SAF_FREQ [3]	0	
2	SAF_FREQ [2]	0	
1	SAF_FREQ [1]	1	
0	SAF_FREQ [0]	0	

7.7 Register 6: Reserved (Default: 50h) (Read Only)

BIT	NAME	PWD	DESCRIPTION
7	Reserved	0	Reserved
6	Reserved	1	
5	Reserved	0	Reserved
4	Reserved	1	
3	Reserved	0	Reserved
2	Reserved	0	
1	Reserved	0	Reserved
0	Reserved	0	

STEPLESS CLOCK FOR VIA PT/PM CHIPSET

7.8 Register 7: Winbond Chip ID (Default: 70h) (Read Only)

BIT	NAME	PWD	DESCRIPTION
7	CHPI_ID [7]	0	Winbond Chip ID. W83194BR-911 (SA5870)
6	CHPI_ID [6]	1	Winbond Chip ID.
5	CHPI_ID [5]	1	Winbond Chip ID.
4	CHPI_ID [4]	1	Winbond Chip ID.
3	CHPI_ID [3]	0	Winbond Chip ID.
2	CHPI_ID [2]	0	Winbond Chip ID.
1	CHPI_ID [1]	0	Winbond Chip ID.
0	CHPI_ID [0]	0	Winbond Chip ID.

7.9 Register 8: M/N Program (Default: 90h)

BIT	NAME	PWD	DESCRIPTION
7	N_DIV [8]	1	Programmable N divisor value. Bit 7 ~0 are defined in the Register 9.
6	M_DIV [6]	0	
5	M_DIV [5]	0	
4	M_DIV [4]	1	
3	M_DIV [3]	0	
2	M_DIV [2]	0	
1	M_DIV [1]	0	
0	M_DIV [0]	0	

7.10 Register 9: M/N Program (Default: 7Ah)

BIT	NAME	PWD	DESCRIPTION
7	N_DIV [7]	0	Programmable N divisor value bit 7 ~0. The bit 8 is defined in Register 8.
6	N_DIV [6]	1	
5	N_DIV [5]	1	
4	N_DIV [4]	1	
3	N_DIV [3]	1	
2	N_DIV [2]	0	
1	N_DIV [1]	1	
0	N_DIV [0]	0	

STEPLESS CLOCK FOR VIA PT/PM CHIPSET

7.11 Register 10: M/N Program (Default: BBh)

BIT	NAME	PWD	DESCRIPTION
7	N_DIV [9]	1	Programmable N divisor bit 9.
6	N3<6>	0	Programmable N3 divisor bit 6 ~0 for programmable 25M clocks. PS: M3=10000 (Fix) N3<8> = 1 (Fix) N3<7> = 1 (Fix) Frequency range: 21.7M ~ 28.8M Resolution: 56K
5	N3<5>	1	
4	N3<4>	1	
3	N3<3>	1	
2	N3<2>	0	
1	N3<1>	1	
0	N3<0>	1	

7.12 Register 11: Spread Spectrum Programming (Default: 0Bh)

BIT	NAME	PWD	DESCRIPTION
7	SP_UP [3]	0	Spread Spectrum Up Counter bit 3 ~ bit 0.
6	SP_UP [2]	0	
5	SP_UP [1]	0	
4	SP_UP [0]	0	
3	SP_DOWN [3]	1	Spread Spectrum Down Counter bit 3 ~ bit 0 2's complement representation. Ex: 1 -> 1111; 2 -> 1110; 7 -> 1001; 8 -> 1000
2	SP_DOWN [2]	0	
1	SP_DOWN [1]	1	
0	SP_DOWN [0]	1	

7.13 Register 12: Divisor and Step-less Enable Control (Default: FBh)

BIT	NAME	PWD	DESCRIPTION
7	M_NACC_EN	1	Enable variable accumulation period for M divisor 1: Enable, 0: Disable (Original timing)
6	DS9	1	Define the AGP divider ratio Table-2 integrate the all divider configuration
5	DS5	1	
4	Reserved	1	Reserved
3	Reserved	1	
2	DS2	0	Define the CPU divider ratio
1	DS1	1	Refer to Table-2
0	DS0	1	

STEPLESS CLOCK FOR VIA PT/PM CHIPSET

7.14 Table-2 CPU, AGP, PCI divider ratio selection Table

LSB MSB		AGP		CPU			
		BIT5		BIT1, 0			
		0	1	00	01	10	11
BIT2/ BIT9	0	Div6	Div7	Div2	Div3	Div4	Div6
	1	Div10	Div12	Div8	Div8	Div8	Div8

7.15 Register 13: Divisor and Step-less Enable Control (Default: 0Fh)

BIT	NAME	PWD	DESCRIPTION
7	EN_MN_PROG	0	0: Output frequency depend on frequency table 1: Program all clock frequency by changing M/N value The equation is $VCO = 14.318MHz * (N+4) / M$ Once the watchdog timer timeout, the bit will be clear. Then the frequency will be decided by hardware default FS<4:0> or desired frequency select SAF_FREQ [4:0] depend on EN_SAFE_FREQ (Reg0 - bit 0).
6	N<10>	0	Programmable N divisor bit 10.
5	DIVM_P1	0	Variable accumulation period for M divisor. Depend On VCO Frequency. 00: 400M 01: 533M 10: 667M 11: 800M
4	DIVM_P0	0	
3	IVAL<3>	1	Charge pump current selection
2	IVAL<2>	1	
1	IVAL<1>	1	
0	IVAL<0>	1	

7.16 Register 14: Control (Default: 0Ah)

BIT	NAME	PWD	DESCRIPTION
7	CPUT_DRI	0	CPUT output state in during POWER DOWN or Stop mode assertion. 1: Driven (2*Iref) 0: Tristate (Floating) CPUC always tri-state (floating) in power down Assertion.
6	Reserved	0	Reserved
5	SPCNT [5]	0	Spread Spectrum Programmable time, the resolution is 280ns. Default period is 11.8us
4	SPCNT [4]	0	
3	SPCNT [3]	1	
2	SPCNT [2]	0	
1	SPCNT [1]	1	
0	SPCNT [0]	0	

STEPLESS CLOCK FOR VIA PT/PM CHIPSET

7.17 Register 15: SST & Skew Control (Default: 2Ch)

BIT	NAME	PWD	DESCRIPTION
7	INV_CPU	0	Invert the CPU phase 0: Default, 1: Inverse
6	Reserved	0	Reserved
5	SPSP_TYPE	1	Spread spectrum implementation method 1: Pendulum type, 0: Original
4	SPSP1	0	Spread Spectrum type select.
3	SPSP0	1	00 : Down 1% 01 : Down 0.5% 10 : Center +/- 0.5% 11 : Center +/- 0.25%
2	ASKEW [2]	1	CPU to AGP skew control, Skew resolution is 340ps
1	ASKEW [1]	0	Expand the skew direction is same as
0	ASKEW [0]	0	CPU_AGP_SKEW [2:0] setting

7.18 Register 16: Skew Control (Default: 24h)

BIT	NAME	PWD	DESCRIPTION
7	INV_AGP	0	Invert the AGP phase, 0: Default, 1: Inverse
6	INV_PCI	0	Invert the PCI phase, 0: Default, 1: Inverse
5	Reserved	1	Reserved
4	Reserved	0	
3	Reserved	0	
2	PSKEW [2]	1	CPU to PCI skew control, Skew resolution is 340ps
1	PSKEW [1]	0	Expand the skew direction is same as
0	PSKEW [0]	0	CPU_PCI_SKEW [2:0] setting

7.19 Register 17: Slew rate Control (Default: 00h)

BIT	NAME	PWD	DESCRIPTION
7	PCI_F2_S2	0	PCI_F2 slew rate control 11: Strong, 00: Weak, 10/01: Normal
6	PCI_F2_S1	0	
5	PCI_F0_S2	0	PCI_F1 / PCI_F0 slew rate control 11 : Strong , 00 : Weak , 10/01 : Normal
4	PCI_F0_S1	0	
3	AGP_2_S2	0	AGP2 slew rate control 11 : Strong , 00 : Weak , 10/01 : Normal
2	AGP_2_S1	0	
1	AGP_10_S2	0	AGP_1 /AGP_0 slew rate control 11 : Strong , 00 : Weak , 10/01 : Normal
0	AGP_10_S1	0	

STEPLESS CLOCK FOR VIA PT/PM CHIPSET

7.20 Register 18: Slew rate Control (Default: 00h)

BIT	NAME	PWD	DESCRIPTION
7	PCI_65_S2	0	PCI6, 5 slew rate control
6	PCI_65_S1	0	11 : Strong , 00 : Weak , 10/01 : Normal
5	PCI_42_S2	0	PCI4, 3,2 slew rate control
4	PCI_42_S1	0	11 : Strong , 00 : Weak , 10/01 : Normal
3	PCI_10_S2	0	PCI1, 0 slew rate control
2	PCI_10_S1	0	11 : Strong , 00 : Weak , 10/01 : Normal
1	REF_S2	0	REF0, 1,2 slew rate control
0	REF_S1	0	11 : Strong , 00 : Weak , 10/01 : Normal

7.21 Register 19: Slew Rate Control (Default: D2h)

BIT	NAME	PWD	DESCRIPTION
7	CPU1STOP_EN	1	Stop CPU1 clocks, 1: Enable stop feature, 0: Disable
6	CPU0STOP_EN	1	Stop CPU0 clocks, 1: Enable stop feature, 0: Disable
5	25MHz_S2	0	25MHz_1,0 slew rate control
4	25MHz_S1	1	11 : Strong , 00 : Weak , 10/01 : Normal
3	INV_48MHz	0	Invert the 48MHz phase, 0: In phase with 24_48MHz 1: 180 degrees out of phase
2	48MHz_S2	0	48MHz/24_48MHz slew rate control
1	48MHz_S1	1	11 : Strong , 00 : Weak , 10/01 : Normal
0	MODE	X	Pin 20,21 Mode selection 1: PCI_STOP, CPU_STOP Control pin 0: PCI5, PCI6 (Default) Default value follow hardware trapping data on MODE ^{&} /PCI0 pin.

7.22 Register 20: Watch dog timer (Default: 08h)

BIT	NAME	PWD	DESCRIPTION
7	SRCF1	0	SRC frequency select, 00/01: 25MHz(Default), 10: 100mhz, 11: 200MHz
6	WD_TIME [6]	0	Setting the down count depth. One bit resolution represents 250ms. Default time depth is 8*250ms = 2.0 second. If the watchdog timer is counting, this register will return present down count value
5	WD_TIME [5]	0	
4	WD_TIME [4]	0	
3	WD_TIME [3]	1	
2	WD_TIME [2]	0	
1	WD_TIME [1]	0	
0	WD_TIME [0]	0	

STEPLESS CLOCK FOR VIA PT/PM CHIPSET

7.23 Register21: Fix mode Control (Default: 00h)

BIT	NAME	PWD	DESCRIPTION
7	Tri-state	0	Tri-state all output if set 1
6	Reserved	0	Don't modify it
5	Reserved	0	Don't modify it
4	FIX_SEL	0	AGP output frequency select mode 0: Output frequency according to frequency selection table 1: Output frequency according to FIX frequency Reg21 bit 0~2
3	SRCF0	0	SRC frequency select
2	ASEL_2	0	Asynchronous AGP/PCI frequency table selection ASEL_<2:0>
1	ASEL_1	0	
0	ASEL_0	0	

STEPLESS CLOCK FOR VIA PT/PM CHIPSET

8. ACCESS INTERFACE

The W83194BR-911 provides I²C Serial Bus for microprocessor to read/write internal registers. In the W83194BR-911 is provided Block Read/Block Write and Byte-Data Read/Write protocol. The I²C address is defined at 0xD2.

Block Read and Block Write Protocol

8.1 Block Write protocol

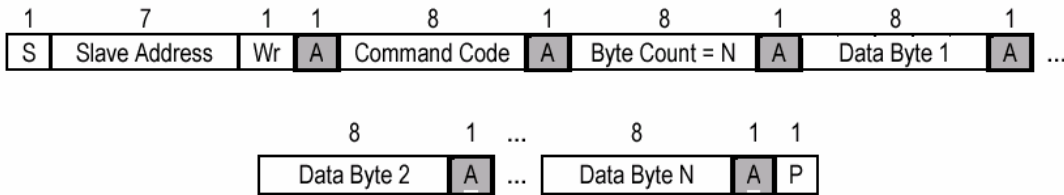

8.2 Block Read protocol

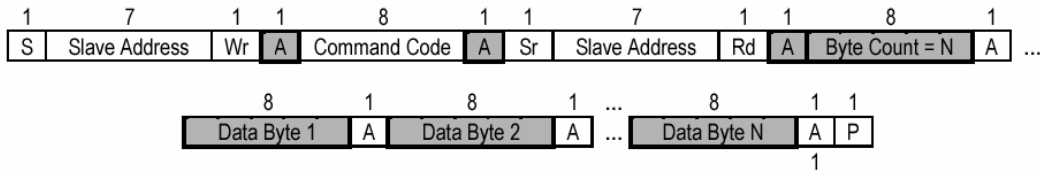

In block mode, the command code must filled 8'h00

8.3 Byte Write protocol

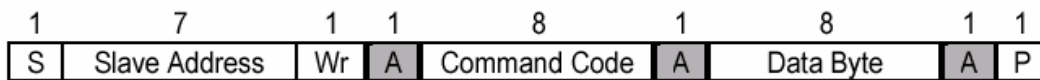

8.4 Byte Read protocol

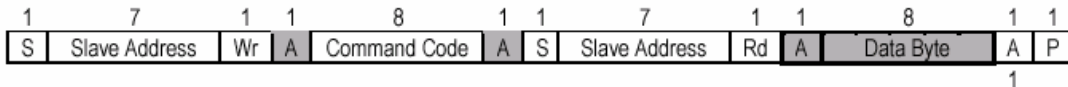

STEPLESS CLOCK FOR VIA PT/PM CHIPSET

9. SPECIFICATIONS

9.1 ABSOLUTE MAXIMUM RATINGS

Stresses greater than those listed in this table may cause permanent damage to the device. Precautions should be taken to avoid application of any voltage higher than the maximum rated voltages to this circuit. Subjection to maximum conditions for extended periods may affect reliability. Unused inputs must always be tied to an appropriate logic voltage level (Ground or VDD).

PARAMETER	RATING
Absolute 3.3V Core Supply Voltage	-0.5V to +4.6V
Absolute 3.3V I/O Supply Voltage	- 0.5 V to + 4.6 V
Operating 3.3V Core Supply Voltage	3.135V to 3.465V
Operating 3.3V I/O Supply Voltage	3.135V to 3.465V
Storage Temperature	- 65°C to + 150°C
Ambient Temperature	- 55°C to + 125°C
Operating Temperature	0°C to + 70°C
Input ESD protection (Human body model)	2000V

9.2 General Operating Characteristics

<i>VDDA=VDDAGP=VDDCPU=VDDREF=VDDPCI= 3.3V ± 5 %, TA = 0°C to +70°C, CI=10pF</i>					
Parameter	Symbol	Min	Max	Units	Test Conditions
Input Low Voltage	V _{IL}		0.8	V _{dc}	
Input High Voltage	V _{IH}	2.0		V _{dc}	
Output Low Voltage	V _{OL}		0.4	V _{dc}	All outputs using 3.3V power
Output High Voltage	V _{OH}	2.4		V _{dc}	All outputs using 3.3V power
Operating Supply Current	I _{dd}		350	mA	CPU = 100 to 400 MHz PCI = 33.3 Mhz with load
Input pin capacitance	C _{in}		5	pF	
Output pin capacitance	C _{out}		6	pF	
Input pin inductance	L _{in}		7	nH	

9.3 Skew Group timing clock

<i>VDDA=VDDAGP=VDDCPU=VDDREF=VDDPCI= 3.3V ± 5 %, TA = 0°C to +70°C, CI=10pF</i>					
PARAMETER	MIN	TYP	MAX	UNITS	TEST CONDITIONS
AGP to PCI Skew	1.5	2.6	3.5	ns	Measured at 1.5V
CPU to CPU Skew			200	ps	Crossing point
AGP to AGP Skew			250	ps	Measured at 1.5V
PCI to PCI Skew			500	ps	Measured at 1.5V
48MHz to 48MHz Skew			1000	ps	Measured at 1.5V
REF to REF Skew			500	ps	Measured at 1.5V

STEPLESS CLOCK FOR VIA PT/PM CHIPSET

9.4 CPU 0.7V Electrical Characteristics

VDDA=VDDCPU= 3.3V ± 5 %, TA = 0°C to +70°C, Test load Rs=33, Rp=49.9 CI=10pF, Vr=475, IREF=2.32mA, Ioh=6*IREF

PARAMETER	MIN	MAX	UNITS	TEST CONDITIONS
Rise Time	175	700	ps	100 to 200 Mhz
Fall Time	175	700	ps	100 to 200Mhz
Absolute crossing point Voltages	250	550	mV	100 to 200Mhz
Cycle to Cycle jitter		150	ps	100 to 200Mhz
Duty Cycle	45	55	%	100 to 200Mhz

9.5 AGP Electrical Characteristics

VDDAGP= 3.3V ± 5 %, TA = 0°C to +70°C, Test load, CI=10pF,

PARAMETER	MIN	MAX	UNITS	TEST CONDITIONS
Rise Time	500	2000	ps	Measure from 0.4V to 2.4V
Fall Time	500	2000	ps	Measure from 2.4V to 0.4V
Cycle to Cycle jitter		250	ps	Measure 1.5V point
Duty Cycle	45	55	%	
Pull-Up Current Min	-33		mA	Vout=1.0V
Pull-Up Current Max		-33	mA	Vout=3.135V
Pull-Down Current Min	30		mA	Vout=1.95V
Pull-Down Current Max		38	mA	Vout=0.4V

9.6 PCI Electrical Characteristics

VDDPCI= 3.3V ± 5 %, TA = 0°C to +70°C, Test load, CI=10pF,

PARAMETER	MIN	MAX	UNITS	TEST CONDITIONS
Rise Time	500	2000	ps	Measure from 0.4V to 2.4V
Fall Time	500	2000	ps	Measure from 2.4V to 0.4V
Cycle to Cycle jitter		250	ps	Measure 1.5V point
Duty Cycle	45	55	%	
Pull-Up Current Min	-33		mA	Vout=1.0V
Pull-Up Current Max		-33	mA	Vout=3.135V
Pull-Down Current Min	30		mA	Vout=1.95V
Pull-Down Current Max		38	mA	Vout=0.4V

STEPLESS CLOCK FOR VIA PT/PM CHIPSET

9.7 24M, 48M Electrical Characteristics

VDDA = 3.3V ± 5 %, TA = 0°C to +70°C, Test load, Cl=10pF,				
PARAMETER	MIN	MAX	UNITS	TEST CONDITIONS
Rise Time	500	2000	ps	Measure from 0.4V to 2.4V
Fall Time	500	2000	ps	Measure from 2.4V to 0.4V
Long term jitter		500	ps	Measure 1.5V point
Duty Cycle	45	55	%	
Pull-Up Current Min	-33		mA	Vout=1.0V
Pull-Up Current Max		-33	mA	Vout=3.135V
Pull-Down Current Min	30		mA	Vout=1.95V
Pull-Down Current Max		38	mA	Vout=0.4V

9.8 REF Electrical Characteristics

VDDR = 3.3V ± 5 %, TA = 0°C to +70°C, Test load, Cl=10pF,				
PARAMETER	MIN	MAX	UNITS	TEST CONDITIONS
Rise Time	1000	4000	ps	Measure from 0.4V to 2.4V
Fall Time	1000	4000	ps	Measure from 2.4V to 0.4V
Cycle to Cycle jitter		1000	ps	Measure 1.5V point
Duty Cycle	45	55	%	
Pull-Up Current Min	-33		mA	Vout=1.0V
Pull-Up Current Max		-33	mA	Vout=3.135V
Pull-Down Current Min	30		mA	Vout=1.95V
Pull-Down Current Max		38	mA	Vout=0.4V

STEPLESS CLOCK FOR VIA PT/PM CHIPSET

10. ORDERING INFORMATION

PART NUMBER	PACKAGE TYPE	PRODUCTION FLOW
W83194BR-911	48 SSOP	Commercial, 0°C to +70°C
W83194BG-911	48 SSOP (Pb-free package)	

11. HOW TO READ THE TOP MARKING

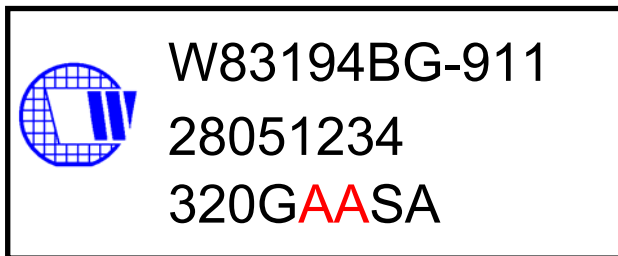
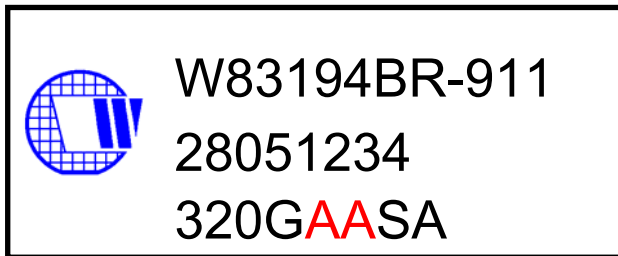

1st line: Winbond logo and the type number: W83194BR-911, W83194BG-911(Pb-free package)

2nd line: Tracking code 2 8051234

2: wafers manufactured in Winbond FAB 2

8051234: wafer production series lot number

3rd line: Tracking code 320 G E D SA

320: packages made in '2003, week 20

G: assembly house ID; O means OSE, G means GR

A: Internal use code

A: IC revision

SA: mask version

All the trademarks of products and companies mentioned in this data sheet belong to their respective owners.

STEPLESS CLOCK FOR VIA PT/PM CHIPSET

12. PACKAGE DRAWING AND DIMENSIONS

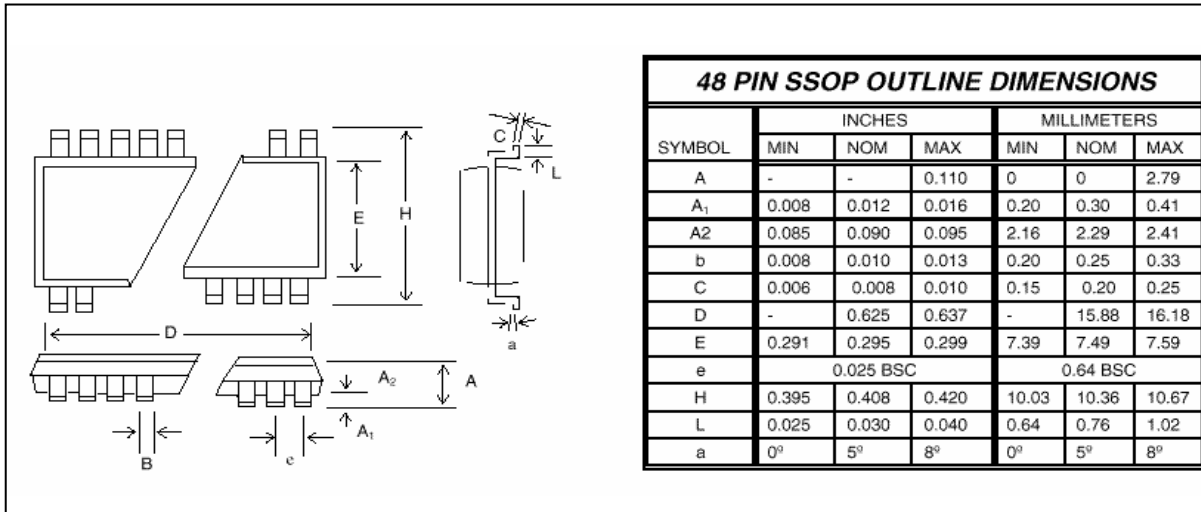

Please note that all data and specifications are subject to change without notice. All the trade marks of products and companies mentioned in this data sheet belong to their respective owners.

Important Notice

Winbond products are not designed, intended, authorized or warranted for use as components in systems or equipment intended for surgical implantation, atomic energy control instruments, airplane or spaceship instruments, transportation instruments, traffic signal instruments, combustion control instruments, or for other applications intended to support or sustain life. Further more, Winbond products are not intended for applications wherein failure of Winbond products could result or lead to a situation wherein personal injury, death or severe property or environmental damage could occur.

Winbond customers using or selling these products for use in such applications do so at their own risk and agree to fully indemnify Winbond for any damages resulting from such improper use or sales.



Headquarters
No. 4, Creation Rd. III,
Science-Based Industrial Park,
Hsinchu, Taiwan
TEL: 886-3-5770066
FAX: 886-3-5665577
<http://www.winbond.com.tw/>

Taipei Office
9F, No.480, Rueiguang Rd.,
Neihu District, Taipei, 114,
Taiwan, R.O.C.
TEL: 886-2-8177-7168
FAX: 886-2-8751-3579

Winbond Electronics Corporation America
2727 North First Street, San Jose,
CA 95134, U.S.A.
TEL: 1-408-9436666
FAX: 1-408-5441798

Winbond Electronics Corporation Japan
7F Daini-ueno BLDG, 3-7-18
Shinyokohama Kohoku-ku,
Yokohama, 222-0033
TEL: 81-45-4781881
FAX: 81-45-4781800

Winbond Electronics (Shanghai) Ltd.
27F, 2299 Yan An W. Rd. Shanghai,
200336 China
TEL: 86-21-62365999
FAX: 86-21-62365998

Winbond Electronics (H.K.) Ltd.
Unit 9-15, 22F, Millennium City,
No. 378 Kwun Tong Rd.,
Kowloon, Hong Kong
TEL: 852-27513100
FAX: 852-27552064

*Please note that all data and specifications are subject to change without notice.
All the trade marks of products and companies mentioned in this data sheet belong to their respective owners.*