

WDD15U SERIES

DC - DC CONVERTER
15W SINGLE & DUAL OUTPUT



FEATURES

- EFFICIENCY UP TO 84%
- 4:1 WIDE INPUT RANGE
- I/O ISOLATION
- INPUT Pi FILTER
- SHORT CIRCUIT PROTECTION
- HIGH PERFORMANCE
- 3 YEARS WARRANTY



EN 60950-1

MODEL LIST

MODEL NO.	INPUT VOLTAGE	INPUT CURRENT (typ.) (max.)		OUTPUT WATTAGE	OUTPUT VOLTAGE	OUTPUT CURRENT	EFF. (min.)	EFF. (typ.)	CAPACITOR LOAD (max.)
-----------	---------------	-------------------------------	--	----------------	----------------	----------------	-------------	-------------	-----------------------

Single Output Models

WDD15 - 03S4U	9~36 VDC	0.79 A	2.2 A	15 WATTS	+3.3 VDC	4500 mA	77%	79%	7000 μ F
WDD15 - 05S4U	9~36 VDC	0.79 A	2.2 A	15 WATTS	+ 5 VDC	3000 mA	78%	80%	7000 μ F
WDD15 - 12S4U	9~36 VDC	0.77 A	2.2 A	15 WATTS	+ 12 VDC	1250mA	80%	82%	470 μ F
WDD15 - 15S4U	9~36 VDC	0.76 A	2.2 A	15 WATTS	+ 15 VDC	1000 mA	81%	83%	220 μ F
WDD15 - 03S5U	18~75 VDC	0.39 A	1.1 A	15 WATTS	+3.3 VDC	4500 mA	77%	79%	7000 μ F
WDD15 - 05S5U	18~75 VDC	0.39 A	1.1 A	15 WATTS	+ 5 VDC	3000 mA	79%	81%	7000 μ F
WDD15 - 12S5U	18~75 VDC	0.38 A	1.1 A	15 WATTS	+ 12 VDC	1250 mA	82%	84%	470 μ F
WDD15 - 15S5U	18~75 VDC	0.38 A	1.1 A	15 WATTS	+ 15 VDC	1000 mA	82%	84%	220 μ F

Dual Output Models

WDD15 - 05D4U	9~36 VDC	0.79 A	2.2 A	15 WATTS	\pm 5 VDC	\pm 1500 mA	78%	80%	\pm 470 μ F
WDD15 - 12D4U	9~36 VDC	0.77 A	2.2 A	15 WATTS	\pm 12 VDC	\pm 630 mA	81%	83%	\pm 100 μ F
WDD15 - 15D4U	9~36 VDC	0.75 A	2.2 A	15 WATTS	\pm 15 VDC	\pm 500 mA	82%	84%	\pm 100 μ F
WDD15 - 05D5U	18~75 VDC	0.39 A	1.1 A	15 WATTS	\pm 5 VDC	\pm 1500 mA	80%	82%	\pm 470 μ F
WDD15 - 12D5U	18~75 VDC	0.38 A	1.1 A	15 WATTS	\pm 12 VDC	\pm 630 mA	82%	84%	\pm 100 μ F
WDD15 - 15D5U	18~75 VDC	0.38 A	1.1 A	15 WATTS	\pm 15 VDC	\pm 500 mA	82%	84%	\pm 100 μ F

SPECIFICATION

All Specifications Typical At Nominal Line, Full Load, 25°C Unless Otherwise Noticed

GENERAL						
Characteristics	Conditions		min.	typ.	max.	unit
Switching frequency	Vi nom, Io nom			250		KHz
Isolation voltage	Input - Output		1,500			VDC
Isolation resistance	Input - Output, @ 500VDC		100			M Ω
Isolation capacitance	100KHz / 1V				1,000	PF
Ambient temperature	Vi nom,	3.3V & 5V output models	-40		+ 61	°C
	Io nom	12V, 15V & dual output models	-40		+ 71	°C

SPECIFICATION

All Specifications Typical At Nominal Line, Full Load, 25°C Unless Otherwise Noticed

GENERAL					
Characteristics	Conditions	min.	typ.	max.	unit
Case temperature	Operating at Vi nom, Io nom			+100	°C
Derating	Vi nom	See derating curve			
Storage temperature	Non operational	-40		+100	°C
Relative humidity	Vi nom, Io nom	20		95	% RH
Temperature coefficient	Vi nom, Io min			± 0.02	% / °C
Dimension		L50.8 x W40.64 x H10.16			mm
MTBF	Belcore issue 6@40°C, GB		1,350,000		Hours
Cooling	Free air convection				

INPUT SPECIFICATIONS					
Characteristics	Conditions	min.	typ.	max.	unit
Input voltage range	Ta min ... Ta max, Io nom	9	24	36	VDC
		18	48	75	VDC
No load input current	Vi nom, Io = 0	24V		20	mA
		48V		15	mA
Input voltage w/o damage	Io nom	24V		40	VDC
		48V		80	VDC
Startup voltage	Io nom	24V	8.5		VDC
		48V	16		VDC
Input filter	Pi type				

OUTPUT SPECIFICATIONS					
Characteristics	Conditions	min.	typ.	max.	unit
Output voltage accuracy	Vi nom, Io nom			± 2	%
Minimum load	Vi nom	single output models	0		%
		dual output models (each output)	10		%
Line regulation	Io nom, Vi min ... Vi max			± 1	%
Load regulation	Vi nom, Io 0 ... Io nom, single output models			± 2	%
	Vi nom, Io min ... Io nom, dual output models			± 5	%
Cross regulation (Dual model)	Aymmetrical load 10% - 100% FL			± 5	%
Startup time	Vi nom, Io nom			30	ms
Transient recovery time	Vi nom, I ~ 0.5 Io nom			500	µs
Ripple & noise	Vi nom, Io nom, BW = 20MHz	3.3V & 5V		100	mV
		12V, 15V & dual		150	mV
Voltage trim range (1)	Vi nom	3.3V	± 5		%
		5V, 12V, 15V & dual	± 10		%
Efficiency	Vi nom, Io nom, Po / Pi	Up to 84%, See model list and efficiency curve			

NOTE 1 : Pls refer to Fig 1 & Table 1 for connection and resistance recommended.

CONTROL AND PROTECTION	
Remote ON / OFF	ON : opened or 8 ~ 10VDC applied, reference to input GND OFF : -0.3 ~ 2VDC applied, reference to input GND
Input reversed	Shunt diode built in, external fuse recommended (24Vin : 2.5A, 48Vin : 1.25A)
Output short circuit	Current limited (Auto-recovery)
Rated over load protection	I 10%min.... I 40%max

APPROVALS AND STANDARD	
UL/cUL	UL 60950-1 Recognized
TUV	EN 60950-1
CE	EN 61204-3, EN 55022, Class A, EN 61000-4-2, EN61000-4-3, EN61000-4-4, EN61000-4-6
Vibration	meet IEC 60068-2-6 (10-500 Hz, 2G, along X, Y, Z each Axis, 60 min for each Axis)

PHYSICAL CHARACTERISTICS

Case size	50.8 x 40.64 x 10.16 mm (2 x 1.6 x 0.4 inches)
Case material	Plastic base / Metal case
Weight	60 g
Potting material	Silicone

MECHANISM & PIN CONFIGURATION

mm [inch]

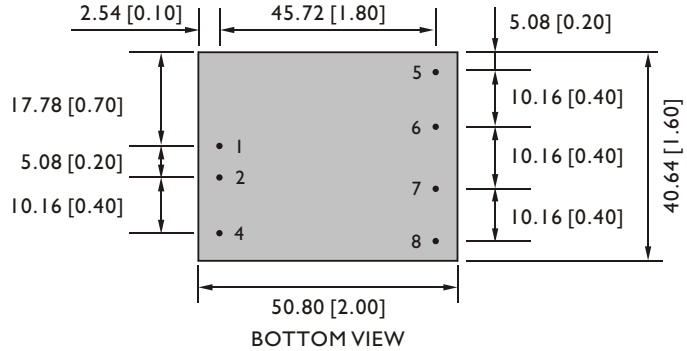
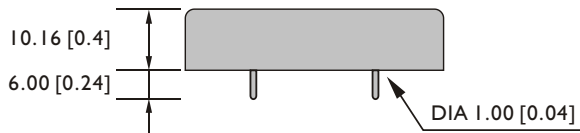

GENERAL TOLERANCE	
0.00[0.00] - 30.00[1.18]	±0.30[0.01]
30.00[1.18] - 120.00[4.72]	±0.50[0.02]

PIN ASSIGNMENT

GENERAL

PIN NO.	1	2	4	5	6	7	8
SINGLE	Vi +	Vi -	ON / OFF	NO PIN	Vo +	Vo -	Trim
DUAL	Vi +	Vi -	ON / OFF	Vo +	com	Vo -	Trim

CIRCUIT SCHEMATIC

• Block diagram for WDD15U series with single output

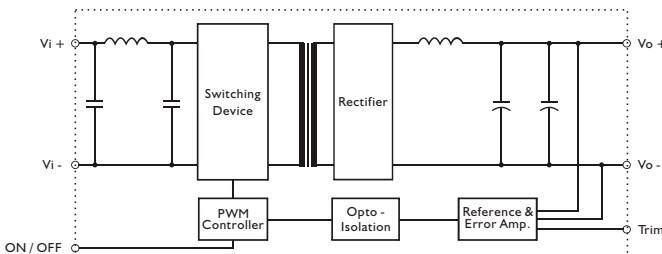

• Block diagram for WDD15U series with dual output

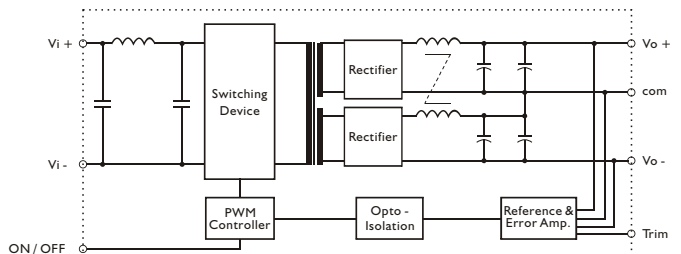

RECOMMENDED CIRCUIT

• Recommended filter for EN55022 Class B compliance

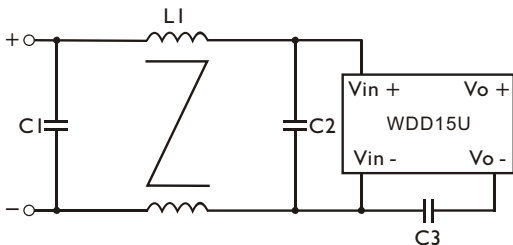

• Recommended EN 55022 Class B filter circuit layout.

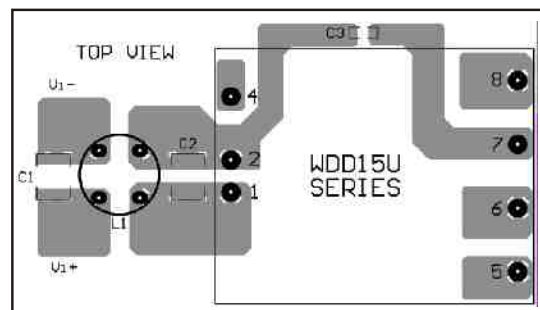

• The components used in the above figure, together with the manufacturer part numbers for these components, are as follows.

	C1	C2	C3	L1
WDD15-XXX4U	1 μ F / 50V MLCC	1 μ F / 50V MLCC	1nF / 2KV MLCC	1.5mH Common Choke
WDD15-XXX5U	3.3 μ F / 100V MLCC	3.3 μ F / 100V MLCC	1nF / 2KV MLCC	3.5mH Common Choke

DERATING AND EFFICIENCY CURVE

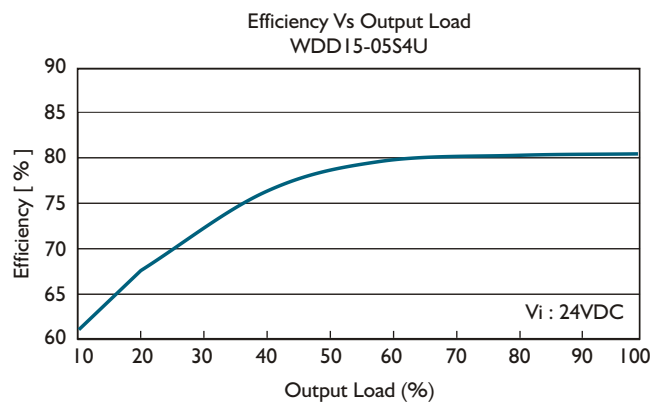
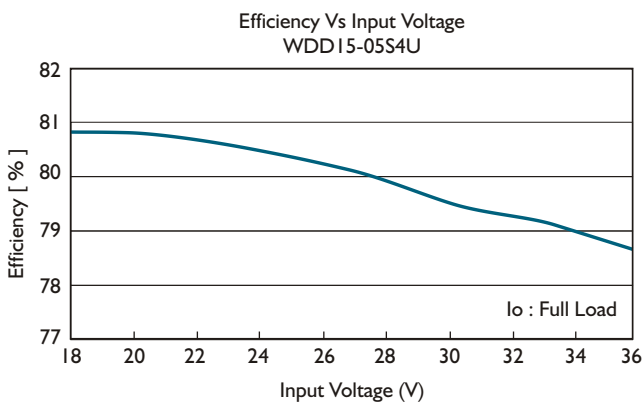
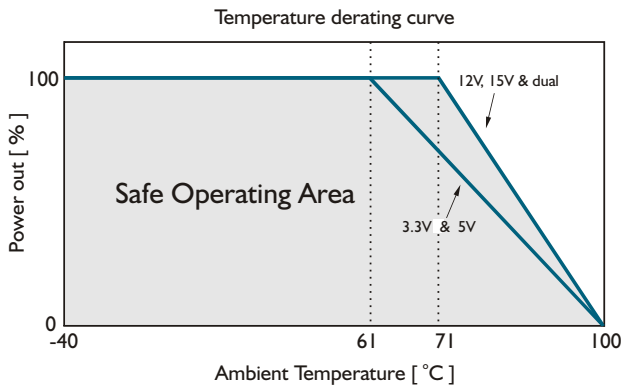
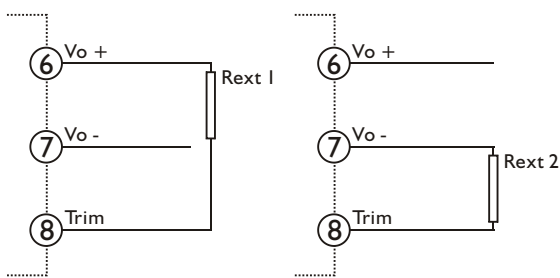

Fig. 1 Trim connection

(For Single output)



(For Dual output)

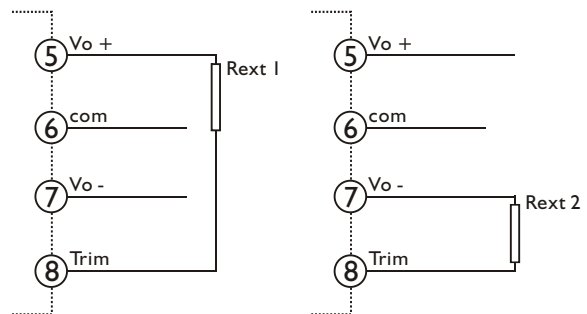

Table 1 Typical resistor values for various output voltage adjustment settings

Type	Rext 1		Rext 2	
	Vo nom -2.5%	Vo nom -5%	Vo nom +2.5%	Vo nom +5%
WDD15-03SXU	680Ω	470Ω	8.2KΩ	3.75KΩ
Type	Vo nom -5%	Vo nom -10%	Vo nom +5%	Vo nom +10%
WDD15-05SXU	4.7KΩ	0Ω	4.7KΩ	390Ω
WDD15-12SXU	43KΩ	12KΩ	5.1KΩ	180Ω
WDD15-15SXU	130KΩ	51KΩ	10KΩ	820Ω
WDD15-05DXU	27KΩ	10KΩ	5.6KΩ	0Ω
WDD15-12DXU	100KΩ	47KΩ	8.66KΩ	680Ω
WDD15-15DXU	270KΩ	120KΩ	18KΩ	2.7KΩ