



7410E RISC Microprocessor HiTCE™ Multichip Package

OVERVIEW

The WEDC 7410E/SSRAM multichip package is targeted for high performance, space sensitive, low power systems and supports the following power management features: doze, nap, sleep and dynamic power management.

The WED3C7410E16M-XBHX multichip package consists of:

- 7410E AltiVec™ RISC processor
- Dedicated 2MB SSRAM L2 cache, configured as 256Kx72
- 21mmx25mm, 255 HiTCE™ Ball Grid Array (CBGA)
- Core frequency = 450 or 400MHz @ 1.8V
- Maximum L2 Cache frequency = 200MHz
- Maximum 60x Bus frequency = 100MHz

The WED3C7410E16M-XBHX is offered in Commercial (0°C to +70°C), industrial (-40°C to +85°C) and military (-55°C to +125°C) temperature ranges and is well suited for embedded applications such as missiles, aerospace, flight computers, fire control systems and rugged critical systems.

FEATURES

- Footprint compatible with WED3C7410E16M-XBX, WED3C7558M-XBX and WED3C750A8M-200BX
- Implementation of AltiVec™ technology instruction set
- Optional, high-bandwidth MPX bus interface
- HiTCE™ interposer for TCE compatibility to laminate substrates for increased Board level reliability
- Available with eutectic or high lead solder balls

* This product is under development, is not qualified or characterized and is subject to change without notice.

FIGURE 1 – MULTI-CHIP PACKAGE DIAGRAM

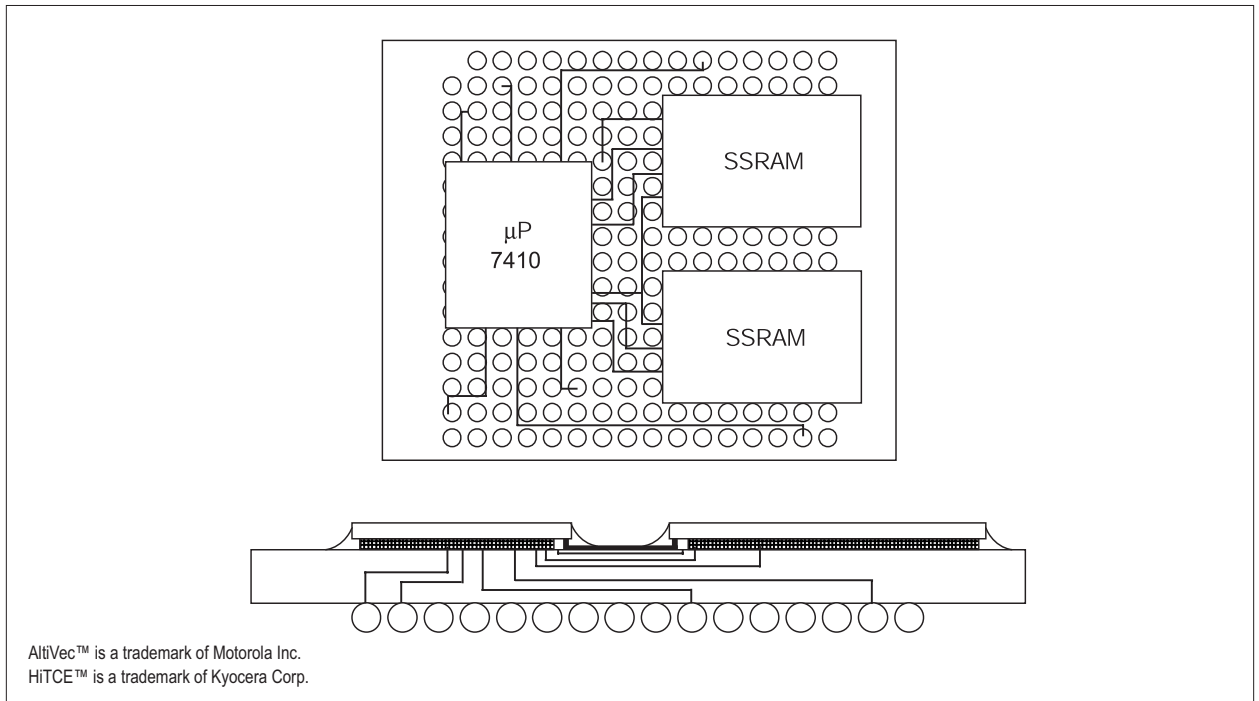

AltiVec™ is a trademark of Motorola Inc.
HiTCE™ is a trademark of Kyocera Corp.



FIGURE 3 – BLOCK DIAGRAM, L2 INTERCONNECT

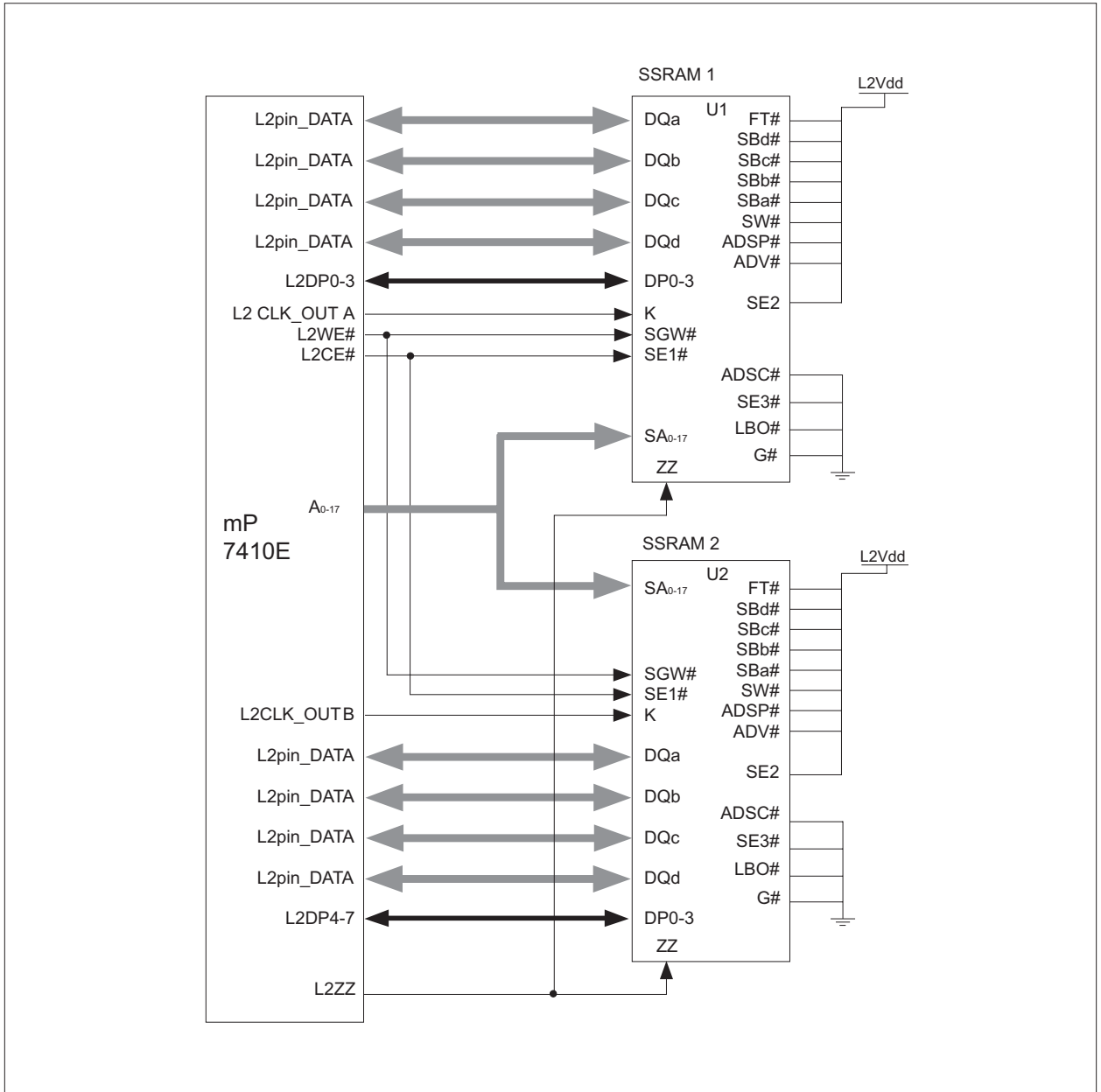

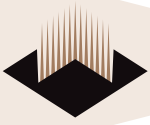
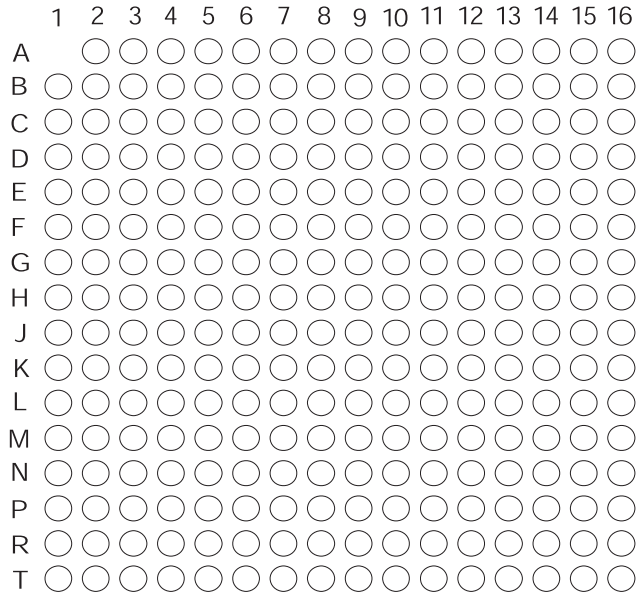
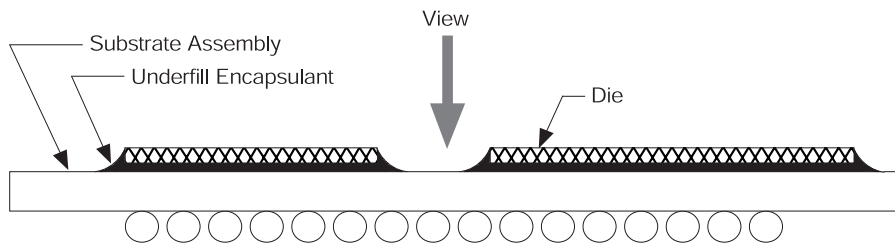

FIGURE 5 – PIN ASSIGNMENTS

Ball assignments of the 255 CBGA package as viewed from the top surface.



Side profile of the CBGA package to indicate the direction of the top surface view.





PACKAGE PINOUT LISTING

SIGNAL NAME	PIN NUMBER	ACTIVE	I/O	1.8V (7)	2.5V (7)	3.3V (7)
A[0-31]	C16, E4, D13, F2, D14, G1, D15, E2, D16, D4, E13, G2, E15, H1, E16, H2, F13, J1, F14, J2, F15, H3, F16, F4, G13, K1, G15, K2, H16, M1, J15, P1	High	I/O			
AACK#	L2	Low	Input			
ABB#/AMONO# (8)	K4	Low	Output			
AP[0-3]	C1, B4, B3, B2	High	I/O			
ARTRY#	J4	Low	I/O			
AVcc	A10	—	Input	1.8V	1.8V	1.8V
BG#	L1	Low	Input			
BR#	B6	Low	Output			
BVSEL (4, 6)	B1	High	Input	GND	HRESET#	OVcc
CHK# (5, 6, 13)	C6	Low	Input			
CI#	E1	Low	I/O			
CKSTP_IN#	D8	Low	Input			
CKSTP_OUT#	A6	Low	Output			
CLK_OUT	D7	High	Output			
DBB#/DMONO (8)	J14	Low	Output			
DBG#	N1	Low	Input			
DBWO#/DTI[0]	G4	Low	Input			
DH[0-31]	P14, T16, R15, T15, R13, R12, P11, N11, R11, T12, T11, R10, P9, N9, T10, R9, T9, P8, N8, R8, T8, N7, R7, T7, P6, N6, R6, T6, R5, N5, T5, T4	High	I/O			
DL[0-31]	K13, K15, K16, L16, L15, L13, L14, M16, M15, M13, N16, N15, N13, N14, P16, P15, R16, R14, T14, N10, P13, N12, T13, P3, N3, N4, R3, T1, T2, P4, T3, R4	High	I/O			
DP[0-7]	M2, L3, N2, L4, R1, P2, M4, R2	High	I/O			
DRDY# (5, 9, 12)	D5	Low	Output			
DTI 1-2 (9, 11)	G16, H15	High	Input			
EMODE# (10, 11)	C4	Low	Input			
GBL#	F1	Low	I/O			
GND	C5, C12, E3, E6, E8, E9, E11, E14, F3, F5, F7, F10, F12, G6, G8, G9, G11, H5, H7, H10, H12, J5, J7, J10, J12, K6, K8, K9, K11, L5, L7, L10, L12, M3, M6, M8, M9, M11, M14, P5, P12	—	—	GND	GND	GND
HIT# (5) (12)	A3	Low	Output			
HRESET#	A7	Low	Input			
INT#	B15	Low	Input			
L1_TSTCLK (1)	D11	High	Input			
L2_TSTCLK (1)	D12	High	Input			
L2AVcc	L11	—	Input	1.8V	1.8V	1.8V
L2Vcc (5) (7)	A2, B8, C3, D6, J16	—	Input	3.3V	3.3V	3.3V
L2OVcc	E10, E12, M12, G12, G14, K12, K14	—	Input		2.5V	N/A
L2VSEL (3, 6)	B5	High	Input	*—	HRESET#	N/A
LSSD_MODE# (1)	B10	Low	Input		3.3V	
MCP#	C13	Low	Input			
NC (No-connect)	B7, C8	—	—			
OVcc (2)	C7, E5, G3, G5, K3, K5, P7, P10, E7, M5, M7, M10	—	Input	1.8V	2.5V	3.3V
PLL_CFG[0-3]	A8, B9, A9, D9	High	Input			
QACK#	D3	Low	Input			
QREQ#	J3	Low	Output			
RSRV#	D1	Low	Output			
SHD0-1# (5) (14)	A4, A5	Low	I/O			
SMI#	A16	Low	Input			
SRESET#	B14	Low	Input			

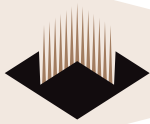

PACKAGE PINOUT LISTING (continued)

SIGNAL NAME	PIN NUMBER	ACTIVE	I/O	1.8V (7)	2.5V (7)	3.3V (7)
SYSCLK	C9	—	Input			
TA#	H14	Low	Input			
TBEN	C2	High	Input			
TBST#	A14	Low	Output			
TCK	C11	High	Input			
TDI (6)	A11	High	Input			
TDO	A12	High	Output			
TEA#	H13	Low	Input			
TMS (6)	B11	High	Input			
TRST# (6)	C10	Low	Input			
TS#	J13	Low	I/O			
TSIZ[0-2]	A13, D10, B12	High	Output			
TT[0-4]	B13, A15, B16, C14, C15	High	I/O			
V _{CC} (2)	F6, F8, F9, F11, G7, G10, H4, H6, H8, H9, H11, J6, J8, J9, J11, K7, K10, L6, L8, L9	—	Input	1.8V	1.8V	1.8V
WT#	D2	Low	I/O			

NOTES:

- These are test signals for factory use only and must be pulled up to OV_{CC} for normal machine operation.
- OV_{CC} inputs supply power to the I/O drivers and V_{CC} inputs supply power to the processor core.
- To allow future L2 cache I/O interface voltage changes.
- To allow processor bus I/O voltage changes, provide the option to connect BVSEL to HRESET# (Selects 2.5V Interface) or to GND (Selects 1.8V Interface) or to OV_{CC} (Selects 3.3V Interface).
- Uses one of 9 existing no-connects in WEDC's WED3C755A8M-300BX.
- Internal pull up on die.
- OV_{CC} supplies power to the processor bus, JTAG, and all control signals except the L2 cache controls (L2CE, L2WE, and L2ZZ); L2OV_{CC} supplies power to the L2 cache I/O interface (L2ADDR (0-18], L2DATA (0-63), L2DP{0-7] and L2SYNC-OUT) and the L2 control signals; L2AV_{CC} supplies power to the SSRAM core memory; and V_{CC} supplies power to the processor core and the PLL and DLL (after filtering to become AV_{CC} and L2AV_{CC} respectively). These columns serve as a reference for the nominal voltage supported on a given signal as selected by the BVSEL pin configuration and the voltage supplied. For actual recommended value of V_{in} or supply voltages see Recommended Operating Conditions.
- Output only for 7410, was I/O for 750/755.
- Enhanced mode only.
- Deasserted (pulled high) at HRESET# for 60x bus mode.
- Reuses 750/755 DRTRY#, DBIS#, and TLBISYNC pins (DT11, DT12, and EMODE# respectively).
- Unused output in 60x bus mode.
- Connect to HRESET# to trigger post power-on-reset (por) internal memory test.
- Ignored in 60x bus mode.

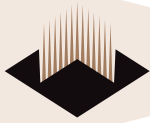

ABSOLUTE MAXIMUM RATINGS

Characteristic	Symbol	Value	Unit	Notes
Core supply voltage	V _{CC}	-0.3 to 2.1	V	(4)
PLL supply voltage	AV _{CC}	-0.3 to 2.1	V	(4)
L2 DLL supply voltage	L2AV _{CC}	-0.3 to 2.1	V	(4)
60x bus supply voltage	OV _{CC}	-0.3 to 3.465	V	(3)
L2 bus supply voltage	L2OV _{CC}	-0.3 to 2.6	V	(3)
L2 supply voltage	L2V _{CC}	-0.3 to 4.6	V	(5)
Input supply	Processor Bus	V _{IN}	-0.3 to 0V _{CC} +0.2	V (2)
	L2 bus	V _{IN}	-0.3 to L2OV _{CC} +0.2	V (2)
	JTAG Signals	V _{IN}	-0.3 to OV _{CC} +0.2	V (2)
Storage temperature range	T _{STG}	-55 to 150	°C	

NOTES:

1. Functional and tested operating conditions are given in Operating Conditions table. Absolute maximum ratings are stress ratings only, and functional operation at the maximums is not guaranteed. Stresses beyond those listed may affect device reliability or cause permanent damage to the device.
2. **Caution:** V_{IN} must not exceed OV_{CC} by more than 0.2V at any time including during power-on reset.
3. **Caution:** OV_{CC}/L2OV_{CC} must not exceed V_{CC}/AV_{CC}/L2AV_{CC} by more than 2.0 V at any time including during power-on reset.
4. **Caution:** V_{CC}/AV_{CC}/L2AV_{CC} must not exceed L2OV_{CC}/OV_{CC} by more than 0.4 V at any time including during power-on reset.
5. L2OV_{CC} should never exceed L2V_{CC}

RECOMMENDED OPERATING CONDITIONS

CHARACTERISTIC		SYMBOL	RECOMMENDED VALUE	UNIT
Core supply voltage		V _{CC}	1.8v ± 100mV	V
PLL supply voltage		AV _{CC}	1.8v ± 100mV	V
L2 DLL supply voltage		L2AV _{CC}	1.8v ± 100mV	V
Memory core supply voltage		L2V _{CC}	3.3v ± 165mV	V
Processor bus supply voltage	BVSEL = 0	OV _{CC}	1.8± 100mV	V
	BVSEL = HRESET#	OV _{CC}	2.5v ± 100mV	V
	BVSEL = HRESET or BVSEL = 1	OV _{CC}	3.3v ± 165 mV	V
L2 bus supply voltage	L2VSEL = HRESET# or 1	L2OV _{CC}	2.5v ± 100 mV	V
Input Voltage	Processor bus and JTAG Signals	V _{IN}	GND to OV _{CC}	V

NOTE: These are the recommended and tested operating conditions. Proper device operation outside of these conditions is not guaranteed

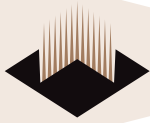

POWER CONSUMPTION

$V_{CC} = AV_{CC} = 1.8 \pm 0.1V$ V_{DC} , $L2V_{CC} = 3.3V \pm 5\% V_{DC}$, $GND = 0 V_{DC}$, $0 \leq T_J < 105^\circ C$

		Processor (CPU) Frequency/L2 Frequency		Unit	Notes
		400MHz/200MHz	450MHz/200MHz		
Full-on Mode	Typical	5.7	6.2	W	1, 3
	Maximum	13.1	14.3	W	1, 2
Doze Mode	Maximum	5.3	5.8	W	1, 2
Nap Mode	Maximum	2.25	2.4	W	1, 2
Sleep Mode	Maximum	2.20	2.35	W	1, 2
Sleep Mode—PLL and DLL Disabled	Maximum	2.0	2.0	W	1, 2

- NOTES:
1. These values apply for all valid system bus and L2 bus ratios. The values do not include OV_{CC} ; AV_{CC} and $L2AV_{CC}$ supplying power. OV_{CC} power is system dependent, but is typically <10% of V_{CC} power. Worst case power consumption, for $AV_{CC} = 15mW$ and $L2AV_{CC} = 15mW$.
 2. Maximum power is measured at $V_{CC} = 1.9 V$ while running an entirely cache-resident, contrived sequence of instructions which keep the execution units maximally busy.
 3. Typical power is an average value measured at $V_{CC} = AV_{CC} = L2AV_{CC} = 1.8V$, $OV_{CC} = L2OV_{CC} = 2.5V$ in a system, executing typical applications and benchmark sequences.

L2 CACHE CONTROL REGISTER (L2CR)

The L2 cache control register, shown in Figure 5, is a supervisor-level, implementation-specific SPR used to configure and operate the L2 cache. It is cleared by hard reset or power-on reset.

FIGURE 5 – L2 CACHE CONTROL REGISTER (L2CR)

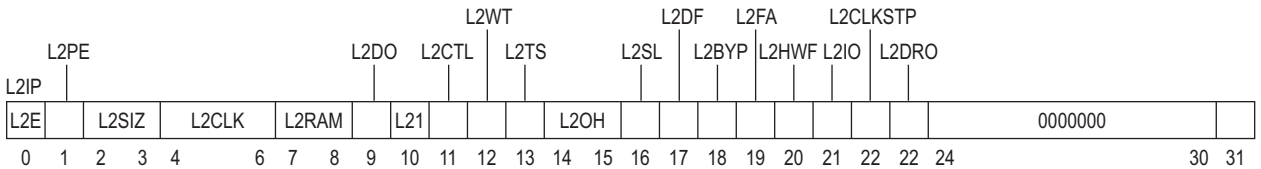

The L2CR bits are described in Table 1.



TABLE 1: L2CR BIT SETTINGS

Bit	Name	Function
0	L2E	L2 enable. Enables L2 cache operation (including snooping) starting with the next transaction the L2 cache unit receives. Before enabling the L2 cache, the L2 clock must be configured through L2CR[2CLK], and the L2 DLL must stabilize. All other L2CR bits must be set appropriately. The L2 cache may need to be invalidated globally.
1	L2PE	L2 data parity checking enable. Enables parity generation and checking for the L2 data RAM interface. When disabled, generated parity is always zeros. L2 Parity is supported by WEDC's WED3C7410E16M-XBHX, but is dependent on application.
2–3	L2SIZ	L2 size—Should be set according to the size of the private memory setting. Total SRAM space is 2M bytes (256Kx72). See L2 cache/private memory configurations table in Motorola User's Manual.
4–6	L2CLK	L2 clock ratio (core-to-L2 frequency divider). Specifies the clock divider ratio based from the core clock frequency that the L2 data RAM interface is to operate at. When these bits are cleared, the L2 clock is stopped and the on-chip DLL for the L2 interface is disabled. For nonzero values, the processor generates the L2 clock and the on-chip DLL is enabled. After the L2 clock ratio is chosen, the DLL must stabilize before the L2 interface can be enabled. The resulting L2 clock frequency cannot be slower than the clock frequency of the 60x bus interface. 000 L2 clock and DLL disabled 001 ÷ 1 010 ÷ 1.5 011 ÷ 3.5 100 ÷ 2 101 ÷ 2.5 110 ÷ 3 111 ÷ 4
7–8	L2RAM	L2 RAM type—Configures the L2 RAM interface for the type of synchronous SRAMs used: • Pipelined (register-register) synchronous burst SRAMs that clock addresses in and clock data out The 7410 does not burst data into the L2 cache, it generates an address for each access. 10: Pipelined (register-register) synchronous burst SRAM - Setting for WED3C7410E16M-XBHX
9	L2DO	L2 data only. Setting this bit enables data-only operation in the L2 cache. When this bit is set, only transactions from the L1 data cache can be cached in the L2 cache. L1 instruction cache operations will be serviced for instruction addresses already in the L2 cache; however, the L2 cache will not be reloaded for L1 instruction cache misses. Note that setting both L2DO and L2IO effectively locks the L2 cache.
10	L2I	L2 global invalidate. Setting L2I invalidates the L2 cache globally by clearing the L2 status bits. This bit must not be set while the L2 cache is enabled. See Motorola's User manual for L2 Invalidation procedure.
11	L2CTL	L2 RAM control (ZZ enable). Setting L2CTL enables the automatic operation of the L2ZZ (low-power mode) signal for cache RAMs. Sleep mode is supported by the WED3C7410E16M-XBHX . While L2CTL is asserted, L2ZZ asserts automatically when the device enters nap or sleep mode and negates automatically when the device exits nap or sleep mode. This bit should not be set when the device is in nap mode and snooping is to be performed through deassertion of QACK.
12	L2WT	L2 write-through. Setting L2WT selects write-through mode (rather than the default write-back mode) so all writes to the L2 cache also write through to the system bus. For these writes, the L2 cache entry is always marked as clean (value unmodified) rather than dirty (value modified). This bit must never be asserted after the L2 cache has been enabled as previously-modified lines can get remarked as clean (value unmodified) during normal operation.
13	L2TS	L2 test support. Setting L2TS causes cache block pushes from the L1 data cache that result from dcbf and dcbst instructions to be written only into the L2 cache and marked valid, rather than being written only to the system bus and marked invalid in the L2 cache in case of hit. This bit allows a dcbz/dcbf instruction sequence to be used with the L1 cache enabled to easily initialize the L2 cache with any address and data information. This bit also keeps dcbz instructions from being broadcast on the system and single-beat cacheable store misses in the L2 from being written to the system bus.
14–15	L2OH	L2 output hold. These bits configure output hold time for address, data, and control signals driven to the L2 data RAMs. 01: 0.8ns Hold Time - Setting for WED3C7410E16M-XBHX

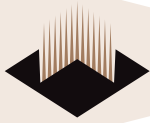
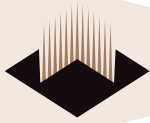

Table 1: L2CR Bit Settings

Bit	Name	Function
16	L2SL	L2 DLL slow. Setting L2SL increases the delay of each tap of the DLL delay line. It is intended to increase the delay through the DLL to accommodate slower L2 RAM bus frequencies. 0: Setting for WED3C7410E16M-XBHX because L2 RAM interface is operated above 100 MHz.
17	L2DF	L2 differential clock. This mode supports the differential clock requirements of late-write SRAMs. 0: Setting for WED3C7410E16M-XBHX because late-write SRAMs are not used.
18	L2BYP	L2 DLL bypass is reserved. 0: Setting for WED3C7410E16M-XBHX
19	L2FA	L2 flush assist (for software flush). When this bit is negated, all lines castout from the dL1 which have a state of CDMRSV=01xxx1 (i.e. C-bit negated), will not allocate in the L2 if they miss. Asserting this bit forces every castout from the dL1 to allocate an entry in the L2 if that castout misses in the L2 regardless of the state of the C-bit. The L2FA bit must be set and the L2IO bit must be cleared in order to use the software flush algorithm.
20	L2HWF	L2 hardware flush. When the processor detects the value of L2HWF set to 1, the L2 will begin a hardware flush. The flush will be done by starting with low cache indices and increment these indices for way 0 of the cache, one index at a time until the maximum index value is obtained. Then, the index will be cleared to zero and the same process is repeated for way 1 of the cache. For each index and way of the cache, the processor will generate a castout operation to the system bus for all modified 32-byte sectors. At the end of the hardware flush, all lines in the L2 tag will be invalidated. During the flush, all memory activity from the icache and dcache are blocked from accessing the L2 until the flush is complete. Snoops, however, are fully serviced by the L2 during the flush. When the L2 tags have been fully flushed of all valid entries, this bit will be reset to b'0" by hardware. When this bit is cleared, it does not necessarily guarantee that all lines from the L2 have been written completely to the system interface. L2 copybacks can still be queued in the bus interface unit. Below is the code which must be run to use L2 Hardware Flush. When the final sync completes, all modified lines in the L2 will have been written to the system address bus. Disable interrupts dssall sync set L2HWF sync
21	L2IO	L2 Instruction-Only. Setting this bit enables instruction-only operation in the L2 cache. For this operation, only transactions from the L1 instruction cache are allowed to be reloaded in the L2 cache. Data addresses already in the cache will still hit for the L1 data cache. When both L2DO and L2IO are asserted, the L2 cache is effectively locked.
22	L2CLKSTP	L2 Clock Stop. Setting this bit enables the automatic stopping of the L2CLK_OUT signals for cache rams that support this function. While L2CLKSTP is set, the L2CLK_OUT signals will automatically be stopped when WED3C7410E16M-XBHX enters nap or sleep mode, and automatically restarted when WED3C7410E16M-XBHX exits nap or sleep.
23	L2DRO	L2 DLL rollover. Setting this bit enables a potential rollover (or actual rollover) condition of the DLL to cause a checkstop for the processor. A potential rollover condition occurs when the DLL is selecting the last tap of the delay line, and thus may risk rolling over to the first tap with one adjustment while in the process of keeping synchronized. Such a condition is improper operation for the DLL, and, while this condition is not expected, it allows detection for added security. This bit can be set when the DLL is first enabled (set with the L2CLK bits) to detect rollover during initial synchronization. It could also be set when the L2 cache is enabled (with L2E bit) after the DLL has achieved its initial lock.
24–30	-	Reserved
31	L2IP	L2 global invalidate in progress (read only)—See the Motorola user's manual for L2 Invalidation procedure.



PLL POWER SUPPLY FILTERING

The AV_{CC} and $L2AV_{CC}$ power signals are provided on the WED3C7410E16M-XBHX to provide power to the clock generation phase-locked loop and L2 cache delay-locked loop respectively. To ensure stability of the internal clock, the power supplied to the AV_{CC} input signal should be filtered of any noise in the 500kHz to 10 MHz resonant frequency range of the PLL. A circuit similar to the one shown in Figure 6 using surface mount capacitors with minimum Effective Series Inductance (ESL) is recommended. Multiple small capacitors of equal value are recommended over a single large value capacitor.

The circuit should be placed as close as possible to the AV_{CC} pin to minimize noise coupled from nearby circuits. An identical but separate circuit should be placed as close as possible to the $L2AV_{CC}$ pin. It is often possible to route directly from the capacitors to the AV_{CC} pin, which is on the periphery of the 255 BGA footprint, without the inductance of vias. The $L2AV_{CC}$ pin may be more difficult to route but is proportionately less critical.

FIGURE 6 – POWER SUPPLY FILTER CIRCUIT

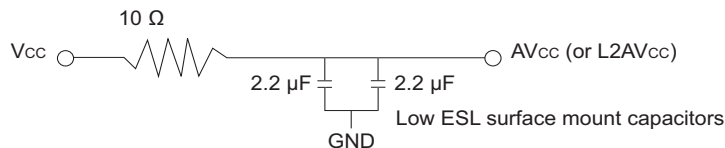



HITCE™ 255 BALL GRID ARRAY - BH PACKAGE (63Pb/37Sn SOLDER BALLS)

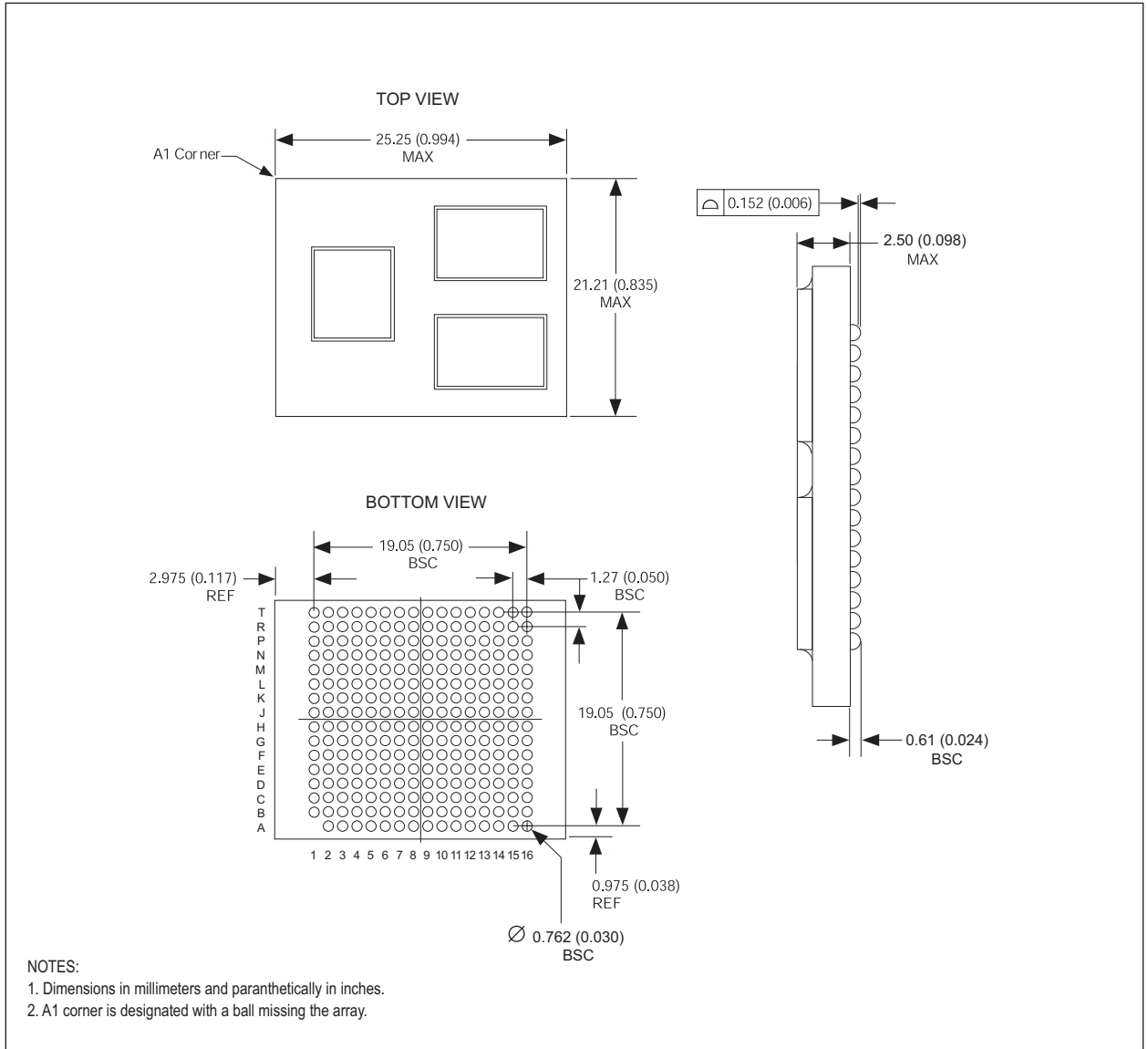



HITCE™ 255 BALL GRID ARRAY - BH9 PACKAGE (90Pb/10Sn SOLDER BALLS)

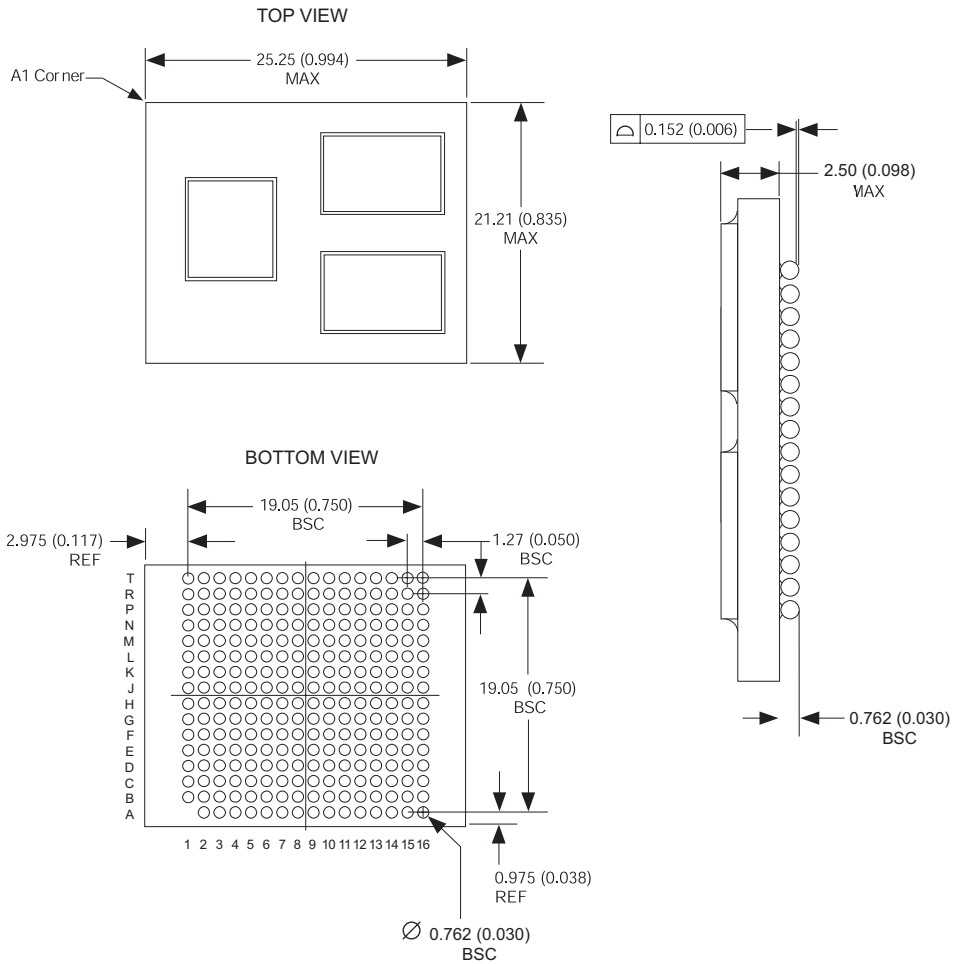

NOTES:

- 1. Dimensions in millimeters and paranthetically in inches.
- 2. A1 corner is designated with a ball missing the array.



HITCE™ MATERIAL PROPERTIES

Item	Unit	CERAMIC	
		Al ₂ O ₃	HiTCE™
Color	—	Black	Green
ELECTRICAL			
Dielectric Constant (1MHz/10GHz)	—	9.8	5.3/5.2
THERMAL			
Coefficient of Linear Thermal Expansion (40~400 degrees C)	1/degree C (x10 ⁻⁶)	7.1	12.3
Thermal Conductivity (20 degrees C)	w / m·k	14	2
MECHANICAL			
Flexural Strength	MPa	400	175
Young's Modulus of Elasticity	GPa	310	75

ORDERING INFORMATION

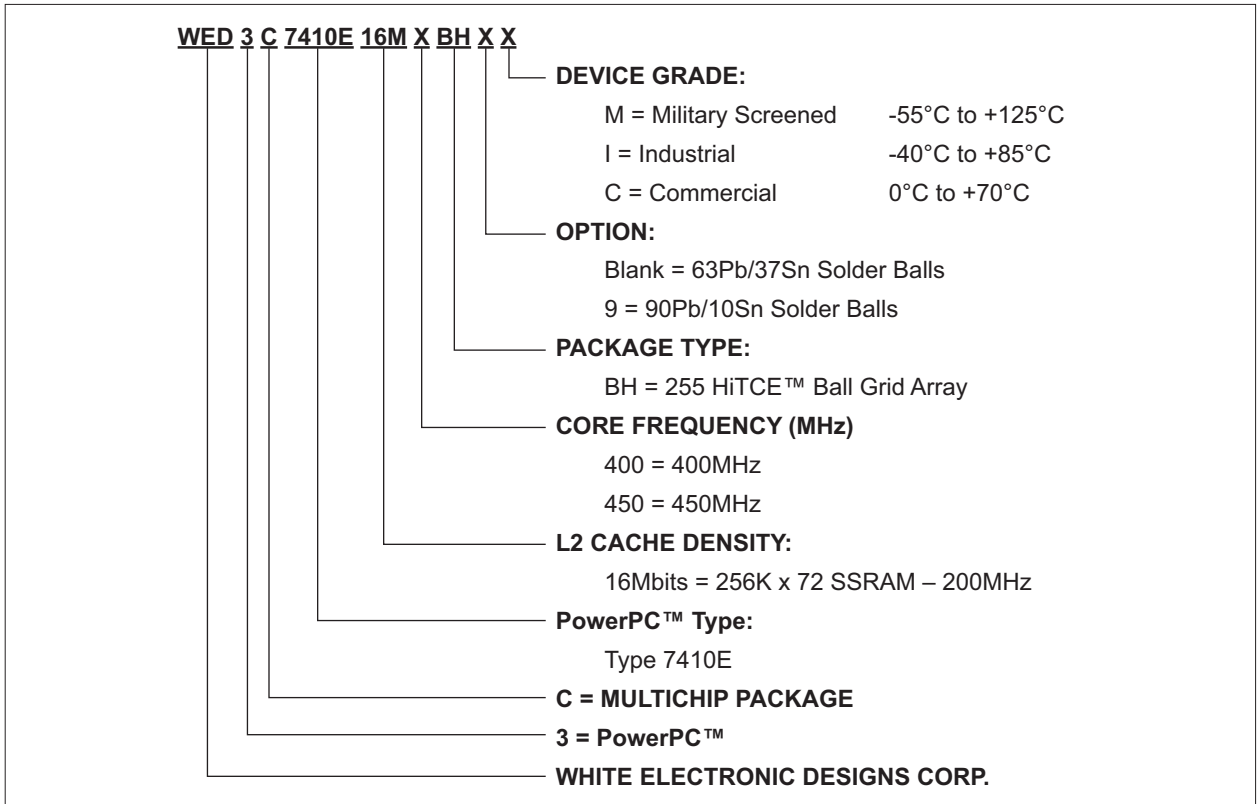

PowerPC™ is a trademark of International Business Machine Corp.
 HiTCE™ is a trademark of Kyocera Corp.



Document Title

7410E RISC Microprocessor HiTCE™ Multichip Package

Revision History

Rev #	History	Release Date	Status
Rev 0	Initial Release	August 2004	Preliminary