

***Silicon N-Channel MOSFET***

**Features**

- 2A,650V(Type), $R_{DS(on)}$ (Max 5 $\Omega$ )@ $V_{GS}=10V$
- Ultra-low Gate Charge(Typical 9.0nC)
- Fast Switching Capability
- 100%Avalanche Tested
- Isolation Voltage( $V_{ISO}=4000V$  AC)
- Maximum Junction Temperature Range(150 $^{\circ}C$ )
- Halogen free(WFF2N65-HF)

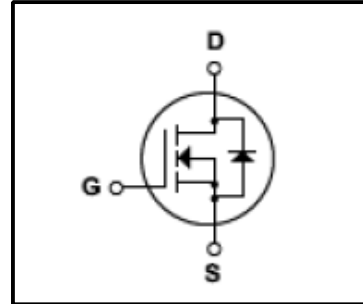

**General Description**

This Power MOSFET is produced using Winsemi's advanced planar stripe, VDMOS technology. This latest technology has been especially designed to minimize on-state resistance, have a high rugged avalanche characteristics. This device is specially well suited for high efficiency switch mode power supply.

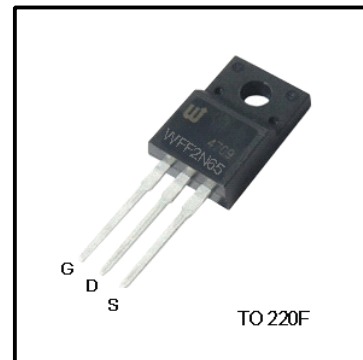

**Absolute Maximum Ratings**

Symbol	Parameter	Value	Units
$V_{DSS}$	Drain Source Voltage	650	V
$I_D$	Continuous Drain Current(@ $T_c=25^{\circ}C$ )	2*	A
	Continuous Drain Current(@ $T_c=100^{\circ}C$ )	1.3*	A
$I_{DM}$	Drain Current Pulsed (Note1)	16*	A
$V_{GS}$	Gate to Source Voltage	$\pm 30$	V
$E_{AS}$	Single Pulsed Avalanche Energy (Note2)	240	mJ
$E_{AR}$	Repetitive Avalanche Energy (Note1)	10	mJ
dv/dt	Peak Diode Recovery dv /dt (Note3)	4.5	V/ ns
$P_D$	Total Power Dissipation(@ $T_c=25^{\circ}C$ )	23	W
	Derating Factor above 25 $^{\circ}C$	0.26	W/ $^{\circ}C$
$T_J, T_{stg}$	Junction and Storage Temperature	-55~150	$^{\circ}C$
$T_L$	Maximum lead Temperature for soldering purposes	300	$^{\circ}C$

\*Drain current limited by maximum junction temperature

**Thermal Characteristics**

Symbol	Parameter	Value			Units
		Min	Typ	Max	
$R_{QJC}$	Thermal Resistance , Junction -to -Case	-	-	5.4	$^{\circ}C/W$
$R_{QCS}$	Thermal Resistance , Case-to-Sink	0.5	-	-	$^{\circ}C/W$
$R_{QJA}$	Thermal Resistance , Junction-to -Ambient	-	-	62.5	$^{\circ}C/W$

## Electrical Characteristics(Tc=25 °C)

Characteristics	Symbol	Test Condition	Min	Type	Max	Unit	
Gate leakage current	I <sub>GSS</sub>	V <sub>GS</sub> =±30V, V <sub>DS</sub> =0V	-	-	±100	nA	
Gate-source breakdown voltage	V <sub>(BR)GSS</sub>	I <sub>G</sub> =±10 μA, V <sub>DS</sub> =0V	±30	-	-	V	
Drain cut -off current	I <sub>DSS</sub>	V <sub>DS</sub> =600V, V <sub>GS</sub> =0V	-	-	10	μA	
		V <sub>DS</sub> =480V, Tc=125 °C	-	-	100	μA	
Drain -source breakdown voltage	V <sub>(BR)DSS</sub>	I <sub>D</sub> =250 μA, V <sub>GS</sub> =0V	650	-	-	V	
Break Voltage Temperature Coefficient	ΔBV <sub>DSS</sub> / T <sub>J</sub>	I <sub>D</sub> =250μA, Referenced to 25 °C		0.65	-		
Gate threshold voltage	V <sub>GS(th)</sub>	V <sub>DS</sub> =10V, I <sub>D</sub> =250 μA	2	-	4	V	
Drain -source ON resistance	R <sub>DS(ON)</sub>	V <sub>GS</sub> =10V, I <sub>D</sub> =1A	-	4.2	5	Ω	
Forward Transconductance	g <sub>fs</sub>	V <sub>DS</sub> =50V, I <sub>D</sub> =1A	-	2.05	-	S	
Input capacitance	C <sub>iss</sub>	V <sub>DS</sub> =25V,	-	380	490	pF	
Reverse transfer capacitance	C <sub>rss</sub>	V <sub>GS</sub> =0V,	-	7.6	9.9		
Output capacitance	C <sub>oss</sub>	f=1MHz	-	35	49		
Switching time	Rise time	tr	V <sub>DD</sub> =300V,	-	15	42	ns
	Turn-on time	ton	I <sub>D</sub> =2A,	-	50	108	
	Fall time	tf	R <sub>G</sub> =25Ω,	-	40	89	
	Turn-off time	toff	(Note4,5)	-	40	89	
Total gate charge(gate-source plus gate-drain)	Q <sub>g</sub>	V <sub>DD</sub> =320V, V <sub>GS</sub> =10V,	-	9.0	19	nC	
Gate-source charge	Q <sub>gs</sub>	I <sub>D</sub> =2A	-	1.7	-		
Gate-drain("miller") Charge	Q <sub>gd</sub>	(Note4,5)	-	7.2	-		

## Source-Drain Ratings and Characteristics(Ta=25 °C)

Characteristics	Symbol	Test Condition	Min	Type	Max	Unit
Continuous drain reverse current	I <sub>DR</sub>	-	-	-	2	A
Pulse drain reverse current	I <sub>DRP</sub>	-	-	-	6	A
Forward voltage(diode)	V <sub>DSF</sub>	I <sub>DR</sub> =2A, V <sub>GS</sub> =0V	-	-	1.4	V
Reverse recovery time	trr	I <sub>DR</sub> =2A, V <sub>GS</sub> =0V,	-	200	-	ns
Reverse recovery charge	Q <sub>rr</sub>	dI <sub>DR</sub> / dt =100 A / μs	-	1.3	-	μC

Note 1.Repeativity rating :pulse width limited by junction temperature

2.L=0.5mH I<sub>AS</sub>=2.0A, V<sub>DD</sub>=50V, R<sub>G</sub>=0Ω ,Starting T<sub>J</sub>=25 °C

3. I<sub>SD</sub>≤2.0A, di/dt≤200A/us, V<sub>DD</sub><BV<sub>DSS</sub>, STARTING T<sub>J</sub>=25 °C

4.Pulse Test:Pulse Width≤300us, Duty Cycle≤2%

5. Essentially independent of operating temperature.

This transistor is an electrostatic sensitive device

Please handle with caution

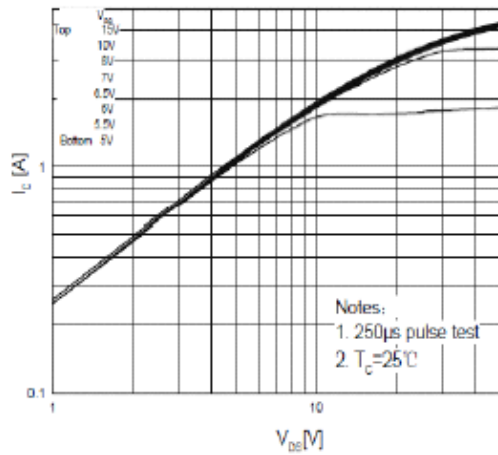

**Fig.1 On-State Characteristics**

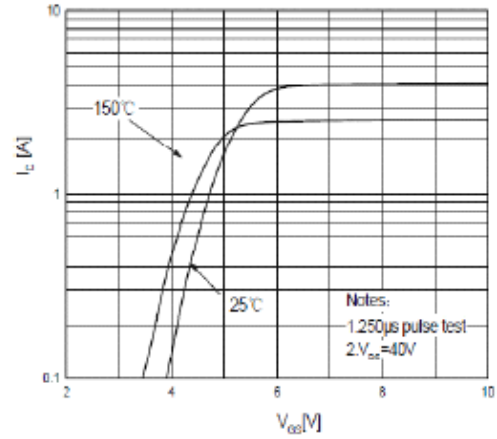

**Fig.2 Transfer Current characteristics**

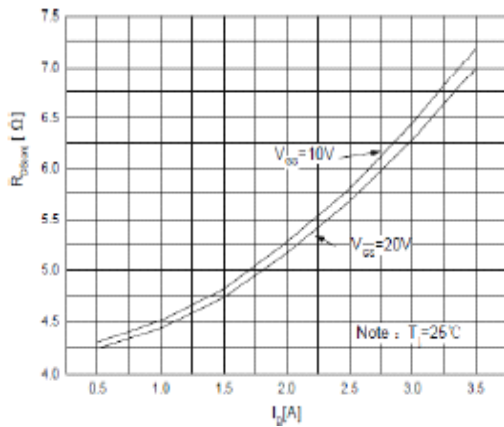

**Fig.3 On Resistance variation vs Drain Current**

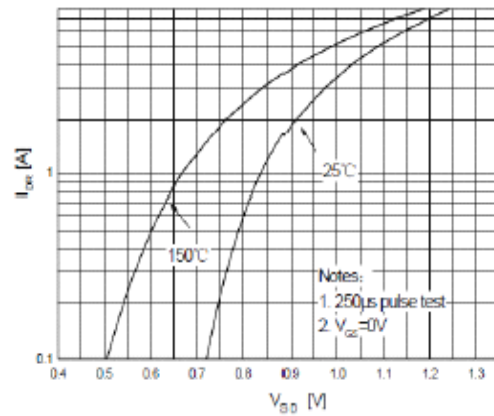

**Fig.4 Body Diode Forward Voltage Variation vs Source Current And temperature**

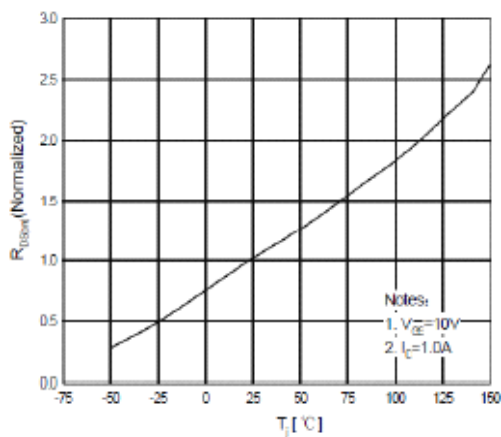

**Fig.5 On-Resistance Variation vs Junction Temperature**

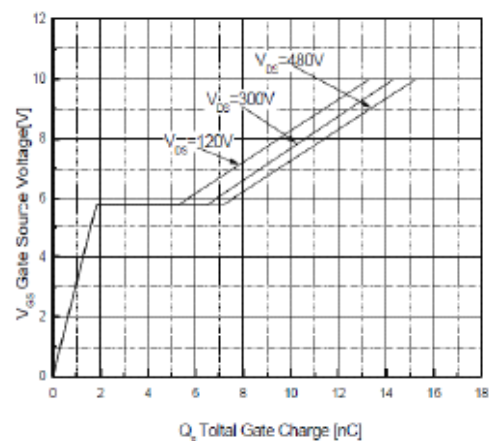

**Fig.6 Gate Charge Characteristics**

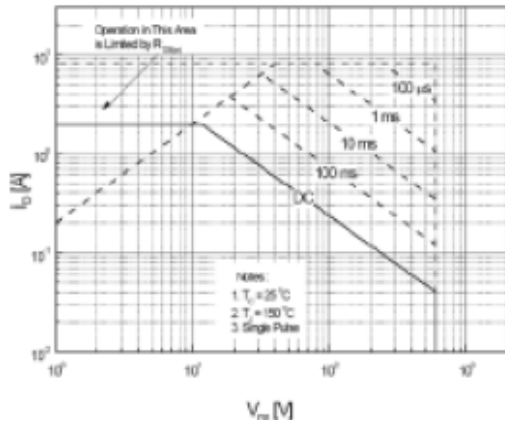

**Fig.7 Maximum Safe Operation Area**

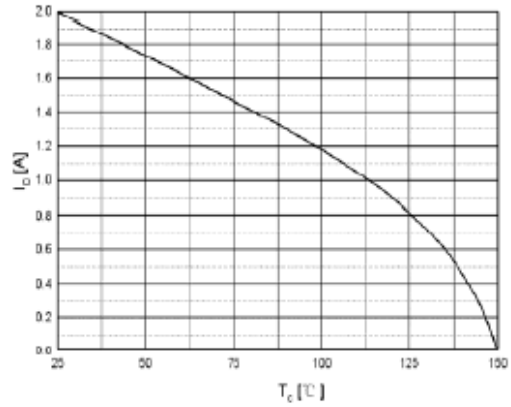

**Fig.8 Maximum Drain Current vs Case Temperature**

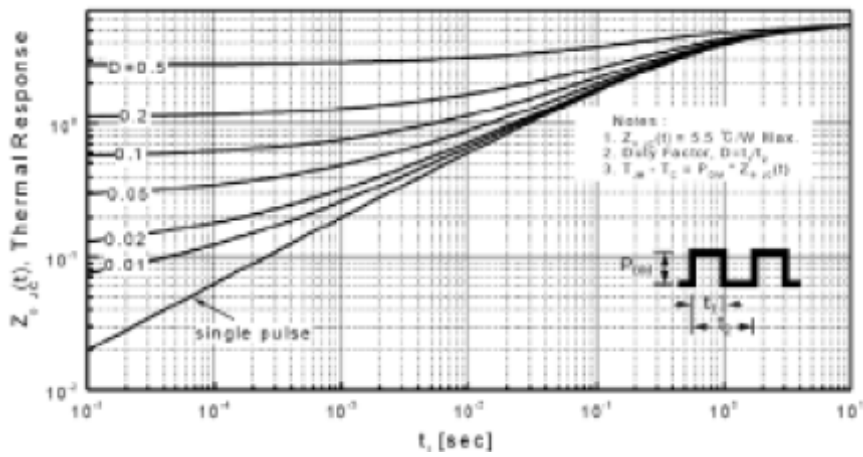

**Fig.9 Transient Thermal Response curve**

**Marking layout**



 : Winsemi Semiconductor Logo

WW : Weekly code(01-52)

YY : Last two digit of calendar year  
(11:2011;12:2012)

□ : HF Halogen free

Null Halogen

△ : Chip serial number

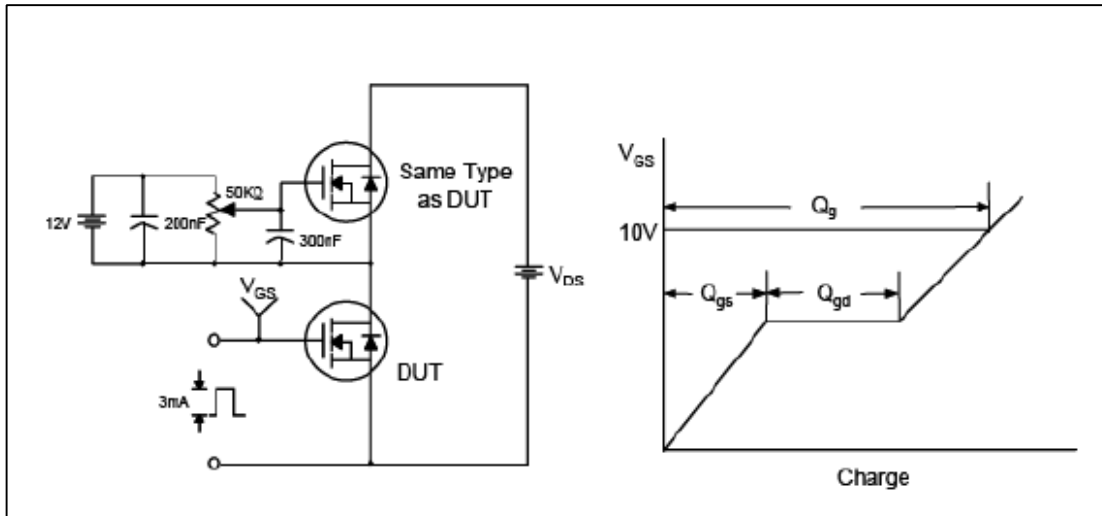

**Fig.10 Gate Test circuit & Waveform**

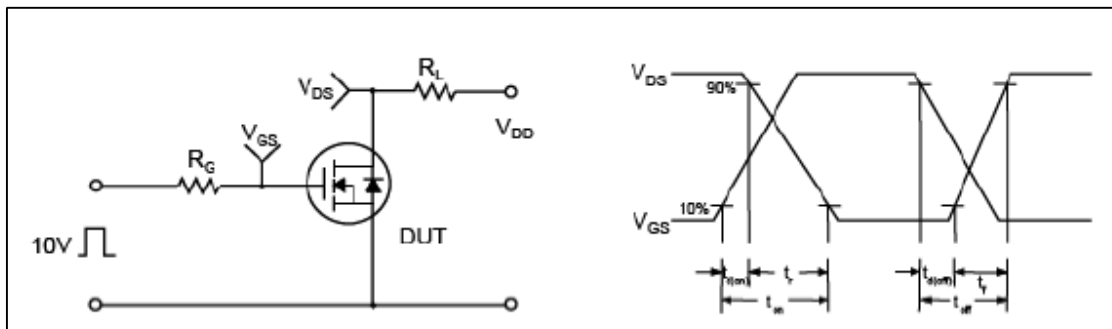

**Fig.11 Resistive Switching Test Circuit & Waveform**

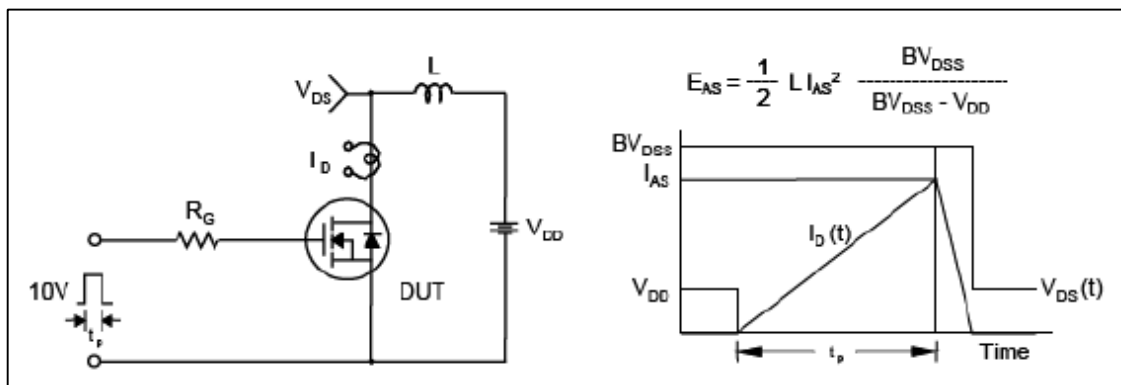

**Fig.12 Uncamped Inductive Switching Test Circuit & Waveform**

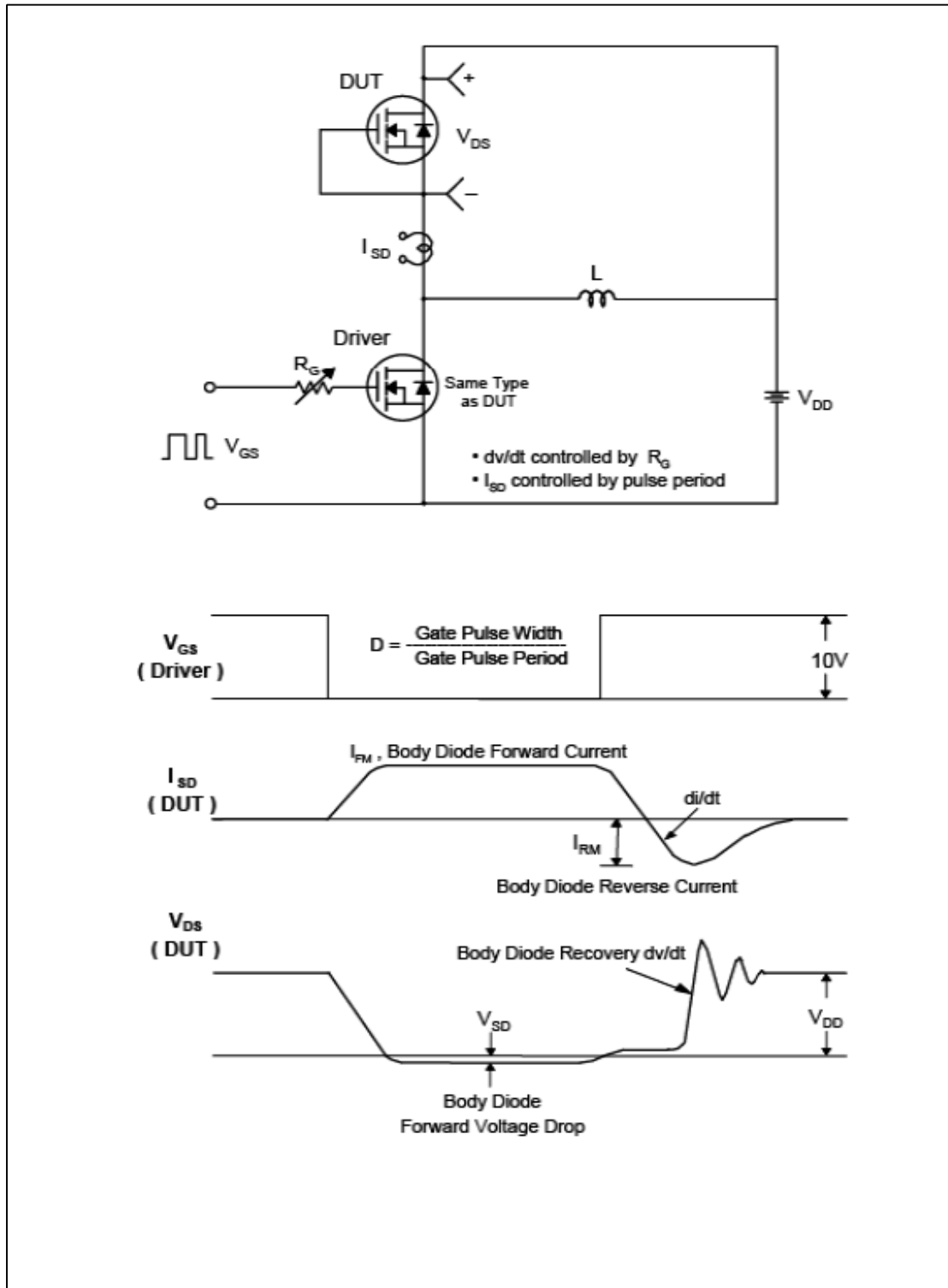

**Fig.13 Peak Diode Recovery  $dv/dt$  Test Circuit & Waveform**

**TO-220F Package Dimension**

