



WL11G-2B2531

W11G-2

PRODUCT PORTFOLIO

SICK
Sensor Intelligence.



Illustration may differ



Ordering information

Type	Part no.
WL11G-2B2531	1041390

Other models and accessories → www.sick.com/W11G-2

Detailed technical data

Features

Sensor/ detection principle	Photoelectric retro-reflective sensor, autocollimation
Dimensions (W x H x D)	15.6 mm x 48.5 mm x 42 mm
Housing design (light emission)	Rectangular
Sensing range max.	0 m ... 4 m ¹⁾
Sensing range	0 m ... 4 m ¹⁾
Type of light	Visible red light
Light source	LED ²⁾
Light spot size (distance)	Ø 25 mm (1.5 m)
Angle of dispersion	Approx. 1.5°
Wave length	640 nm
Adjustment	Potentiometer, 11 turns

¹⁾ Reflector PL80A.

²⁾ Average service life: 100,000 h at T_J = +25 °C.

Communication interface

Communication interface	-
--------------------------------	---

Mechanics/electronics

Supply voltage	10 V DC ... 30 V DC ¹⁾
Ripple	$\leq 5 V_{pp}$ ²⁾
Power consumption	$\leq 30 \text{ mA}$ ³⁾
Output type	PNP ⁴⁾ NPN ⁵⁾
Switching mode	Light/dark switching ^{4) 5)}
Switching mode selector	Selectable via L/D control cable
Signal voltage PNP HIGH/LOW	$U_v - 3 \text{ V}$ / approx. 0 V
Signal voltage NPN HIGH/LOW	Approx. $U_v / < 3 \text{ V}$
Output current I_{max}	100 mA
Response time	$\leq 330 \mu\text{s}$ ⁶⁾
Switching frequency	1,500 Hz ⁷⁾
Attenuation along light beam	> 8 %
Connection type	Male connector M12, 5-pin
Circuit protection	A ⁸⁾ C ⁹⁾ D ¹⁰⁾
Protection class	II
Weight	120 g
Polarisation filter	✓
Housing material	Plastic, ABS
Optics material	Plastic, PMMA
Enclosure rating	IP66 IP67 IP69K
Special feature	Detecting transparent objects
Ambient operating temperature	-30 °C ... +60 °C
Ambient storage temperature	-40 °C ... +75 °C
UL File No.	NRKH.E181493 & NRKH7.E181493

¹⁾ Limit values when operated in short-circuit protected network: max. 8 A.

²⁾ May not exceed or fall below U_v tolerances.

³⁾ Without load.

⁴⁾ 0 V or not connected, light switching.

⁵⁾ U_v , dark switching.

⁶⁾ Signal transit time with resistive load.

⁷⁾ With light/dark ratio 1:1.

⁸⁾ A = V_S connections reverse-polarity protected.

⁹⁾ C = interference suppression.

¹⁰⁾ D = outputs overcurrent and short-circuit protected.

Classifications

ECl@ss 5.0	27270902
ECl@ss 5.1.4	27270902
ECl@ss 6.0	27270902

ECl@ss 6.2	27270902
ECl@ss 7.0	27270902
ECl@ss 8.0	27270902
ECl@ss 8.1	27270902
ECl@ss 9.0	27270902
ETIM 5.0	EC002717
ETIM 6.0	EC002717
UNSPSC 16.0901	39121528

Adjustments possible

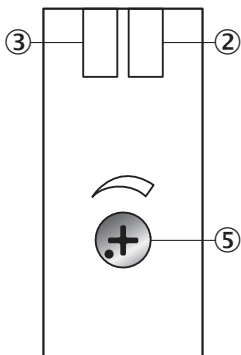

- ② LED indicator green: Supply voltage active
- ③ LED indicator yellow: Status of received light beam
- ⑤ Sensitivity control

Connection diagram

Cd-145

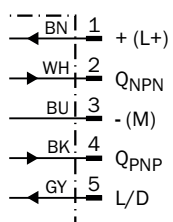

Characteristic curve

WL11G-2

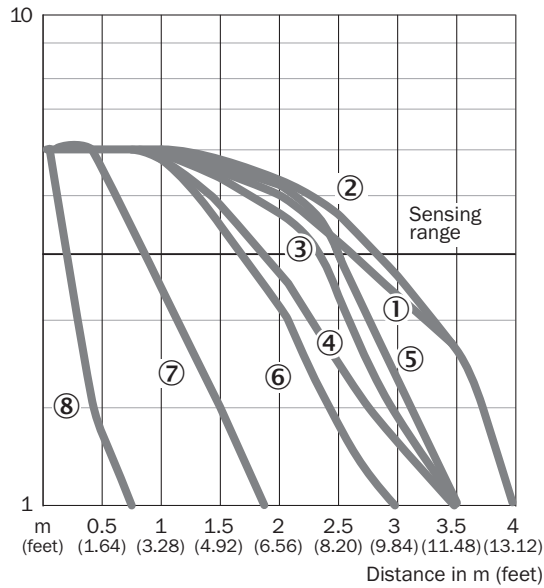

- ① Reflector PL80A
- ② Reflector C110A
- ③ Reflector P250F
- ④ Reflector PL50A
- ⑤ Reflector PL40A
- ⑥ Reflector PL30A
- ⑦ Reflector PL20A
- ⑧ Reflective tape Diamond Grade

Sensing range diagram

WL11G-2

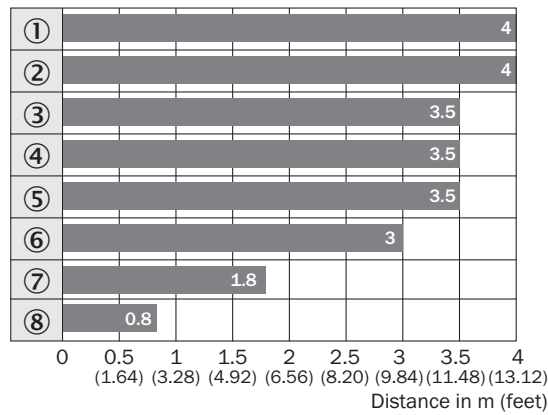

- Sensing range
- ① Reflector PL80A
- ② Reflector C110A
- ③ Reflector P250F
- ④ Reflector PL50A
- ⑤ Reflector PL40A
- ⑥ Reflector PL30A
- ⑦ Reflector PL20A
- ⑧ Reflective tape Diamond Grade



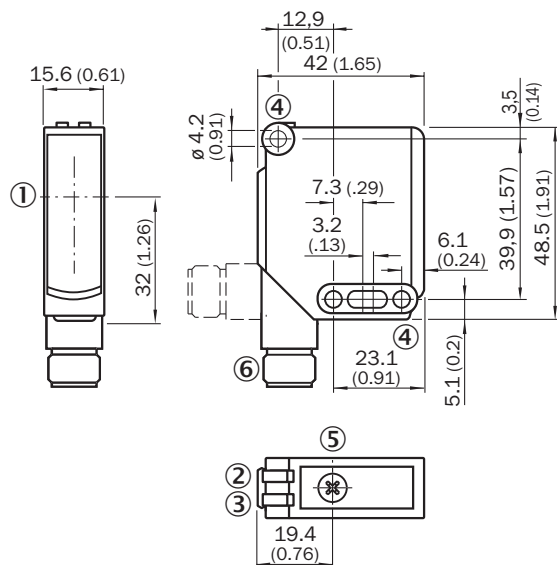

Dimensional drawing (Dimensions in mm (inch))



- ① Center of optical axis
- ② LED indicator green: Supply voltage active
- ③ LED indicator yellow: Status of received light beam
- ④ Mounting hole \varnothing 4.2 mm
- ⑤ Sensitivity control: potentiometer
- ⑥ Male connector M12, cable with male connector M12 or cable

Recommended accessories





Other models and accessories → www.sick.com/W11G-2

	Brief description	Type	Part no.
Universal bar clamp systems			
	Plate N02 for universal clamp bracket, Zinc plated steel (sheet), Zinc die cast (clamping bracket), Universal clamp (5322626), mounting hardware	BEF-KHS-N02	2051608
	Plate N03 for universal clamp bracket, zinc coated, Zinc plated steel (sheet), Zinc die cast (clamping bracket), Universal clamp (5322626), mounting hardware	BEF-KHS-N03	2051609
	Plate N04 for universal clamp, steel, Zinc plated steel (sheet), Zinc die cast (clamping bracket), Universal clamp (5322626), mounting hardware	BEF-KHS-N04	2051610
Device protection (mechanical)			
	Protective housing for universal clamp, Zinc plated steel (protective housing), Zinc die cast (clamping bracket), Universal clamp, mounting hardware	BEF-SG-W12-3	2045175

¹⁾ Customizable length by sheet. Width max. 74.9 cm, length max. 91.4 cm.

	Brief description	Type	Part no.
Mounting brackets and plates			
	Mounting bracket, large, Stainless steel, mounting hardware included	BEF-WG-W12	2013942
	Mounting bracket, small, Stainless steel, mounting hardware included	BEF-WK-W12	2012938
Terminal and alignment brackets			
	Double clamp bracket for dovetail mounting, Aluminum (anodised), mounting hardware included	BEF-DKH-W12	2013947
	Clamping block for dovetail mounting, Aluminum (anodised), mounting hardware included	BEF-KH-W12	2013285
Reflectors			
	Rectangular, screw connection, 80 mm x 80 mm, PMMA/ABS, Screw-on, 2 hole mounting	PL80A	1003865
	Fine triple reflector, screw connection, suitable for laser sensors, 47 mm x 47 mm, PMMA/ABS, Screw-on, 2 hole mounting	P250F	5308843
	Fine triple reflector, screw connection, suitable for laser sensors, 18 mm x 18 mm, PMMA/ABS, Screw-on, 2 hole mounting	PL10F	5311210
	Fine triple reflector, screw connection, suitable for laser sensors, 38 mm x 16 mm, PMMA/ABS, Screw-on, 2 hole mounting	PL20F	5308844
	Fine triple reflector, screw connection, suitable for laser sensors, 56 mm x 28 mm, PMMA/ABS, Screw-on, 2 hole mounting	PL30F	5326523
	Fine triple reflector, screw connection, suitable for laser sensors, 76 mm x 45 mm, PMMA/ABS, Screw-on, 2 hole mounting	PL81-1F	5325060
	Suitable for laser sensors, self-adhesive, cut, see alignment note, 56.3 mm x 56.3 mm, self-adhesive	REF-AC1000-56	4063030
	"Diamond grade" reflective tape, self-adhesive, ready to assemble from the sheet, 74.9 cm x 91.4 cm ¹⁾ , self-adhesive	REF-DG-K	4019634
	Chemically resistant, screw connection, 47 mm x 47 mm, Plastic, Screw-on, 2 hole mounting	P250 CHEM	5321097
	Fine triple reflector, chemically resistant, screw connection, 18 mm x 18 mm, Plastic, Screw-on, 2 hole mounting	PL10F CHEM	5321636

¹⁾ Customizable length by sheet. Width max. 74.9 cm, length max. 91.4 cm.

	Brief description	Type	Part no.
	Chemically resistant, screw connection, suitable for laser sensors, 16 mm x 38 mm, Plastic, Screw-on, 2 hole mounting	PL20F-CHEM	5326089
	Stainless steel reflector, hygienic design, chemically resistant, enclosure rating IP69K, D12 adapter shaft, 25 mm x 25 mm, Stainless steel V4A (1.4404, 316L), D12-adapter shaft	PLH25-D12	2063404
	Stainless steel reflector, hygienic design, chemically resistant, Enclosure rating IP 69K, M12-adapter thread, 25 mm x 25 mm, Stainless steel V4A (1.4404, 316L), M12-adapter thread	PLH25-M12	2063403
	Stainless steel reflector, washdown design, chemically resistant, IP 69K enclosure rating, screw connection, 14 mm x 14 mm, Stainless steel V4A (1.4404, 316L), Screw-on, 2 hole mounting	PLV14-A	2063405

¹⁾ Customizable length by sheet. Width max. 74.9 cm, length max. 91.4 cm.

SICK AT A GLANCE

SICK is one of the leading manufacturers of intelligent sensors and sensor solutions for industrial applications. A unique range of products and services creates the perfect basis for controlling processes securely and efficiently, protecting individuals from accidents and preventing damage to the environment.

We have extensive experience in a wide range of industries and understand their processes and requirements. With intelligent sensors, we can deliver exactly what our customers need. In application centers in Europe, Asia and North America, system solutions are tested and optimized in accordance with customer specifications. All this makes us a reliable supplier and development partner.

Comprehensive services complete our offering: SICK LifeTime Services provide support throughout the machine life cycle and ensure safety and productivity.

For us, that is “Sensor Intelligence.”

WORLDWIDE PRESENCE:

Contacts and other locations – www.sick.com