



WLG4S-3F2234

W4S-3 Glass

PHOTOELECTRIC SENSORS

SICK
Sensor Intelligence.



Illustration may differ



Ordering information

Type	Part no.
WLG4S-3F2234	1042084

Other models and accessories → www.sick.com/W4S-3_Glass

Detailed technical data

Features

Sensor/detection principle	Photoelectric retro-reflective sensor, autocollimation
Dimensions (W x H x D)	12.2 mm x 41.8 mm x 17.3 mm
Housing design (light emission)	Rectangular
Sensing range max.	0.01 m ... 5 m ¹⁾
Sensing range	0 m ... 3 m ¹⁾
Type of light	Visible red light
Light source	PinPoint LED ²⁾
Light spot size (distance)	Ø 45 mm (1.5 m)
Wave length	650 nm
Adjustment	Cable Single teach-in button
AutoAdapt	✓

¹⁾ Reflector PL80A.

²⁾ Average service life: 100,000 h at T_J = +25 °C.

Mechanics/electronics

Supply voltage	10 V DC ... 30 V DC ¹⁾
Ripple	< 5 V _{pp} ²⁾
Power consumption	≤ 20 mA ³⁾
Output type	PNP
Switching mode	Dark switching
Output current I_{max.}	≤ 100 mA
Response time	< 0.5 ms ⁴⁾
Switching frequency	1,000 Hz ⁵⁾
Attenuation along light beam	> 8 %
Connection type	Connector M8, 4-pin
Circuit protection	A ⁶⁾ C ⁷⁾ D ⁸⁾
Protection class	III
Weight	30 g
Polarisation filter	✓
Housing material	Plastic, ABS, Plastic, PMMA
Optics material	Plastic, PMMA
Enclosure rating	IP67 IP66
Special feature	Detecting transparent objects
Ambient operating temperature	-40 °C ... +60 °C
Ambient storage temperature	-40 °C ... +75 °C
UL File No.	NRKH.E181493 & NRKH7.E181493

¹⁾ Limit values.

²⁾ May not exceed or fall below U_v tolerances.

³⁾ Without load.

⁴⁾ Signal transit time with resistive load.

⁵⁾ With light/dark ratio 1:1.

⁶⁾ A = V_S connections reverse-polarity protected.

⁷⁾ C = interference suppression.

⁸⁾ D = outputs overcurrent and short-circuit protected.

Classifications

ECl@ss 5.0	27270902
ECl@ss 5.1.4	27270902
ECl@ss 6.0	27270902
ECl@ss 6.2	27270902
ECl@ss 7.0	27270902
ECl@ss 8.0	27270902
ECl@ss 8.1	27270902
ECl@ss 9.0	27270902
ETIM 5.0	EC002717

ETIM 6.0	EC002717
UNSPSC 16.0901	39121528

Connection diagram

Cd-092

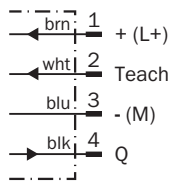

Characteristic curve

WL4S-3, WLG4S-3, 5 m

Operating reserve

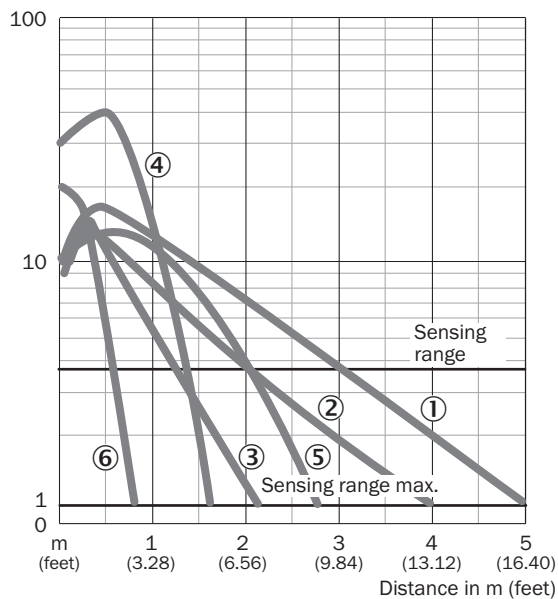

- ① Reflector PL80A
- ② Reflector PL40A
- ③ Reflector PL20A
- ④ PL10F reflector
- ⑤ Reflector P250 CHEM
- ⑥ Reflective tape REF-IRF-56

Light spot size

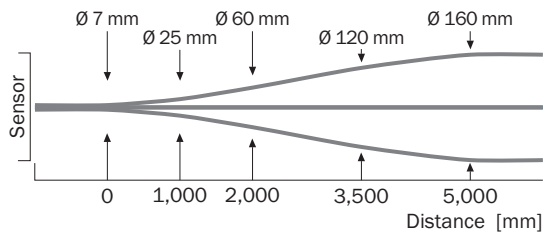

Sensing range diagram

WL4S-3, WLG4S-3, 5 m

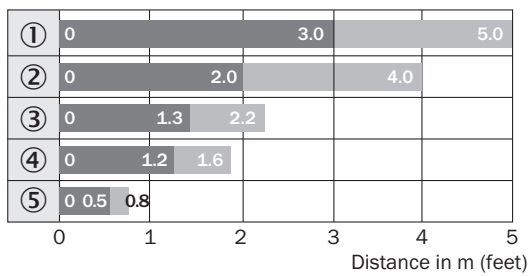

■ Sensing range ■ Sensing range max.

- ① Reflector PL80A
- ② Reflector PL40A
- ③ Reflector PL20A
- ④ PL10F reflector
- ⑤ Reflective tape REF-IRF-56

Dimensional drawing (Dimensions in mm (inch))

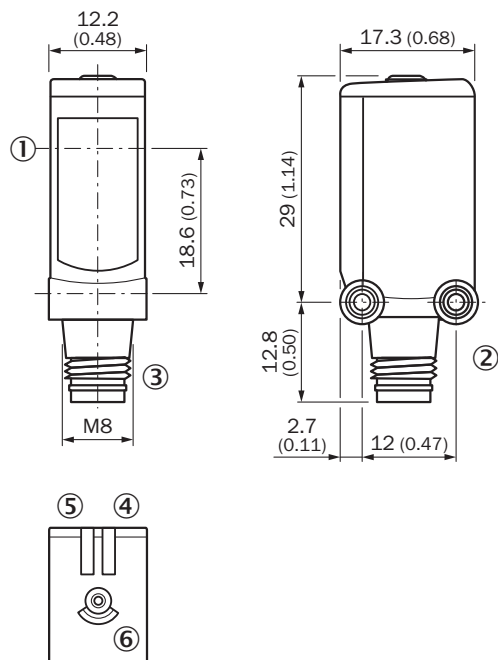

WL4S-3, WL4S-3, single teach-in button





- ① Center of optical axis
- ② Threaded mounting hole M3
- ③ Connection
- ④ LED indicator green: Supply voltage active
- ⑤ LED indicator orange: status of received light beam
- ⑥ Teach-in button

Recommended accessories

Other models and accessories → www.sick.com/W4S-3_Glass

	Brief description	Type	Part no.
Universal bar clamp systems			
	Plate N02 for universal clamp bracket, Zinc plated steel (sheet), Zinc die cast (clamping bracket), Universal clamp (5322626), mounting hardware	BEF-KHS-N02	2051608
	Plate N02N for universal clamp bracket, Stainless steel 1.4571 (sheet), Stainless steel 1.4408 (clamp), Universal clamp (5322626), mounting hardware	BEF-KHS-N02N	2051618
	Plate N08 for universal clamp bracket, Zinc plated steel (sheet), Zinc die cast (clamping bracket), Universal clamp (5322626), mounting hardware	BEF-KHS-N08	2051607
	Plate N08N for universal clamp bracket, Stainless steel 1.4571 (sheet), Stainless steel 1.4408 (clamp), Universal clamp (5322626), mounting hardware	BEF-KHS-N08N	2051616
Device protection (mechanical)			
	Safety bracket for floor mounting, Stainless steel 1.4571, mounting hardware included	BEF-SW-W4S	2051497

	Brief description	Type	Part no.
Plug connectors and cables			
	Head A: female connector, M8, 4-pin, straight Head B: cable Cable: PVC, unshielded, 2 m	DOL-0804-G02M	6009870
	Head A: female connector, M8, 4-pin, straight Head B: cable Cable: PVC, unshielded, 5 m	DOL-0804-G05M	6009872
	Head A: female connector, M8, 4-pin, angled Head B: cable Cable: PVC, unshielded, 2 m	DOL-0804-W02M	6009871
	Head A: female connector, M8, 4-pin, angled Head B: cable Cable: PVC, unshielded, 5 m	DOL-0804-W05M	6009873
	Head A: female connector, M8, 4-pin, straight Head B: - Cable: unshielded	DOS-0804-G	6009974
	Head A: female connector, M8, 4-pin, angled Head B: - Cable: unshielded	DOS-0804-W	6009975
	Head A: male connector, M8, 4-pin, straight Head B: - Cable: unshielded	STE-0804-G	6037323
Reflectors			
	Rectangular, screw connection, 80 mm x 80 mm, PMMA/ABS, Screw-on, 2 hole mounting	PL80A	1003865
	Fine triple reflector, screw connection, suitable for laser sensors, 47 mm x 47 mm, PMMA/ABS, Screw-on, 2 hole mounting	P250F	5308843
	Fine triple reflector, screw connection, suitable for laser sensors, 18 mm x 18 mm, PMMA/ABS, Screw-on, 2 hole mounting	PL10F	5311210
	Fine triple reflector, screw connection, suitable for laser sensors, 38 mm x 16 mm, PMMA/ABS, Screw-on, 2 hole mounting	PL20F	5308844
	Fine triple reflector, screw connection, suitable for laser sensors, 56 mm x 28 mm, PMMA/ABS, Screw-on, 2 hole mounting	PL30F	5326523
	Fine triple reflector, screw connection, suitable for laser sensors, 76 mm x 45 mm, PMMA/ABS, Screw-on, 2 hole mounting	PL81-1F	5325060
	Suitable for laser sensors, self-adhesive, cut, see alignment note, 56.3 mm x 56.3 mm, self-adhesive	REF-AC1000-56	4063030
	Fine triple reflector, chemically resistant, screw connection, 18 mm x 18 mm, Plastic, Screw-on, 2 hole mounting	PL10F CHEM	5321636
	Chemically resistant, screw connection, suitable for laser sensors, 16 mm x 38 mm, Plastic, Screw-on, 2 hole mounting	PL20F-CHEM	5326089

	Brief description	Type	Part no.
	Stainless steel reflector, hygienic design, chemically resistant, enclosure rating IP69K, D12 adapter shaft, 25 mm x 25 mm, Stainless steel V4A (1.4404, 316L), D12-adapter shaft	PLH25-D12	2063404
	Stainless steel reflector, hygienic design, chemically resistant, Enclosure rating IP 69K, M12-adapter thread, 25 mm x 25 mm, Stainless steel V4A (1.4404, 316L), M12-adapter thread	PLH25-M12	2063403
	Stainless steel reflector, washdown design, chemically resistant, IP 69K enclosure rating, screw connection, 14 mm x 14 mm, Stainless steel V4A (1.4404, 316L), Screw-on, 2 hole mounting	PLV14-A	2063405

SICK AT A GLANCE

SICK is one of the leading manufacturers of intelligent sensors and sensor solutions for industrial applications. A unique range of products and services creates the perfect basis for controlling processes securely and efficiently, protecting individuals from accidents and preventing damage to the environment.

We have extensive experience in a wide range of industries and understand their processes and requirements. With intelligent sensors, we can deliver exactly what our customers need. In application centers in Europe, Asia and North America, system solutions are tested and optimized in accordance with customer specifications. All this makes us a reliable supplier and development partner.

Comprehensive services complete our offering: SICK LifeTime Services provide support throughout the machine life cycle and ensure safety and productivity.

For us, that is “Sensor Intelligence.”

WORLDWIDE PRESENCE:

Contacts and other locations –www.sick.com