



Photoelectric sensors
W250-2, Photoelectric proximity sensor,
Background suppression

WTB250-2P1251



Type > [WTB250-2P1251](#)
Part No. > [6044691](#)



Illustration may differ

At a glance

- Visible red Bright Light LED
- Background suppression
- Potentiometer with an easy-to-read positioning indicator for adjusting the sensing range
- Cable or rotatable M12 connector
- Operating mode (light/dark) selectable via control wire
- Versions for 10 - 30 V DC or 24 - 240 V DC/ 24 – 240 V AC voltage supply in compact design

Your benefits

- Visible red light Bright Light LED simplifies alignment and easy-to-read positioning indicator for simple commissioning
- Reliable object detection in difficult ambient light conditions
- Cable or rotatable M12 connector provide installation flexibility
- Operating mode (light/dark) is selectable via a control cable to reduce the number of device variants
- Variants with DC voltage and universal AC/DC voltage in the same housing provide increased flexibility



Features

Sensor/detection principle:	Photoelectric proximity sensor, Background suppression
Dimensions (W x H x D):	20 mm x 65 mm x 43.9 mm
Housing design (light emission):	Rectangular
Sensing range max.:	200 mm ... 1,000 mm ¹⁾
Sensing range:	200 mm ... 1,000 mm ²⁾
Type of light:	Visible red light
Light source:	BrightLight LED ³⁾
Angle of dispersion:	Ca. 3 °
Adjustment:	Potentiometer, 2 turns
Light spot size (distance):	Ø 35 mm (1,000 mm)

^{1) 2)} Object with 90 % reflectance (referred to standard white, DIN 5033) ³⁾ Average service life of 100,000 h at T_A = +25 °C ⁴⁾ With position indicator

Mechanics/electronics

Supply voltage:	10 V DC ... 30 V DC ¹⁾
Ripple:	≤ 5 Vpp ²⁾
Power consumption:	≤ 35 mA ³⁾
Output type:	PNP, open collector
Switching mode:	Light/dark switching
Switching mode selector:	Selectable via L/D control wire
Output current I _{max} :	≤ 100 mA
Response time:	≤ 3 ms ⁴⁾
Switching frequency:	160 Hz ⁵⁾
Connection type:	Cable, 4-wire, 5 m ⁶⁾
Cable material:	PVC
Conductor cross-section:	0.18 mm ²
Cable diameter:	Ø 3.8 mm
Circuit protection:::	A, B, C, D ^{7) 8) 9) 10)}
Protection class:	III
Weight:	150 g
Optics material:	PMMA
Enclosure rating:	IP 67
Items supplied:	BEF-W250 mounting bracket
EMC:	EN 60947-5-2 ¹¹⁾
Ambient operating temperature:	-25 °C ... +55 °C
Ambient storage temperature:	-40 °C ... +70 °C
UL File No.:	NRKH2.E300503 & NRKH8.E300503
Housing material:	ABS, Plastic

¹⁾ Limit values, operation in short-circuit protected network max. 8 A ²⁾ May not exceed or fall short of V_S tolerances ³⁾ Without load ⁴⁾ Signal transit time with resistive load ⁵⁾ With light/dark ratio 1:1 ⁶⁾ Do not bend below 0 °C ⁷⁾ A = V_S connections reverse-polarity protected ⁸⁾ B = inputs and output reverse-polarity protected ⁹⁾ C = interference suppression ¹⁰⁾ D = outputs overcurrent and short-circuit protected ¹¹⁾ The AC/DC devices meet the interference suppression requirements for industrial use (interference suppression class A). When used in residential areas it can cause interference.

Dimensional drawing

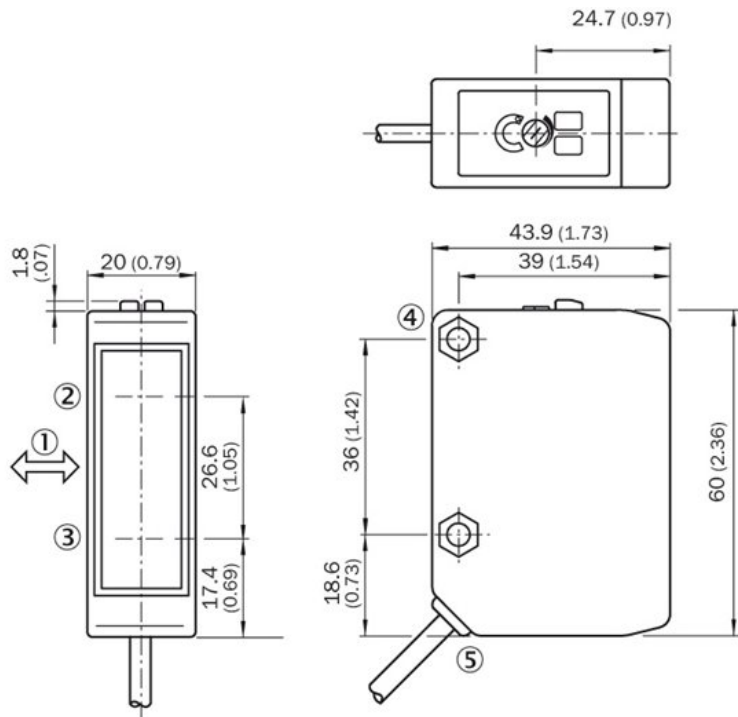

- |1| Standard direction of the material being detected
- |2| Axis of sender
- |3| axis of receiver
- |4| Mounting hole \varnothing 4.2 mm,
for M4 hexagon nut on both sides
- |5| Connection cable

Adjustments possible

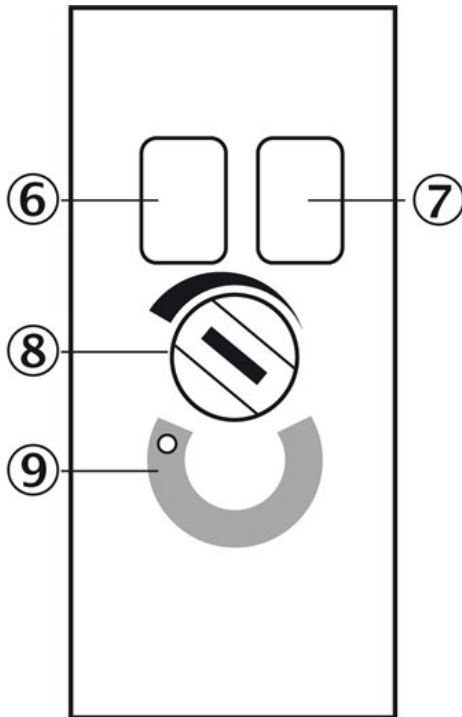

- |6| LED indicator green: Stability indicator
- |7| Status indicator LED,
yellow: Status of received light beam
- |8| Sensing range adjustment: potentiometer
- |9| Position indicator for sensitivity setting (270°)

Connection diagram

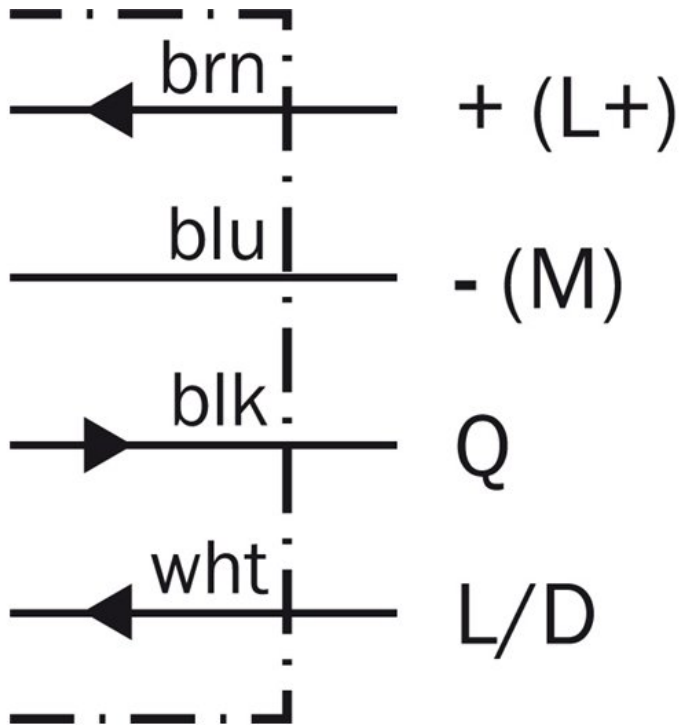

Characteristic curve

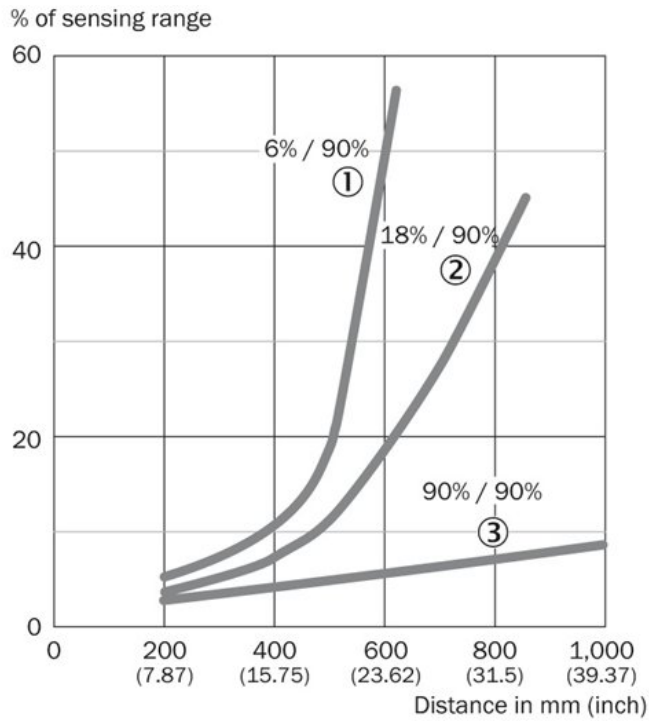

- [1] Sensing range on black, background white
- [2] Sensing range on gray, background white
- [3] Sensing range on white, background white

Sensing range diagram

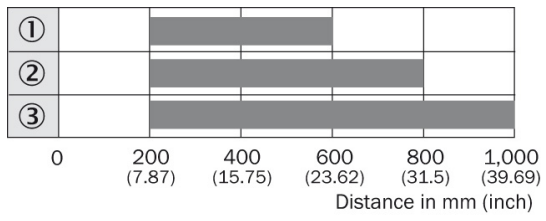

■ Sensing range

Australia

Phone +61 3 9457 0600
1800 33 48 02 – tollfree
E-Mail sales@sick.com.au

Belgium/Luxembourg

Phone +32 (0)2 466 55 66
E-Mail info@sick.be

Brasil

Phone +55 11 3215-4900
E-Mail marketing@sick.com.br

Canada

Phone +1 905 771 14 44
E-Mail information@sick.com

Česká republika

Phone +420 2 57 91 18 50
E-Mail sick@sick.cz

China

Phone +86 4000 121 000
E-Mail info.china@sick.net.cn
Phone +852-2153 6300
E-Mail ghk@sick.com.hk

Danmark

Phone +45 45 82 64 00
E-Mail sick@sick.dk

Deutschland

Phone +49 211 5301-301
E-Mail info@sick.de

España

Phone +34 93 480 31 00
E-Mail info@sick.es

France

Phone +33 1 64 62 35 00
E-Mail info@sick.fr

Great Britain

Phone +44 (0)1727 831121
E-Mail info@sick.co.uk

India

Phone +91-22-4033 8333
E-Mail info@sick-india.com

Israel

Phone +972-4-6881000
E-Mail info@sick-sensors.com

Italia

Phone +39 02 27 43 41
E-Mail info@sick.it

Japan

Phone +81 (0)3 5309 2112
E-Mail support@sick.jp

Magyarország

Phone +36 1 371 2680
E-Mail office@sick.hu

Nederland

Phone +31 (0)30 229 25 44
E-Mail info@sick.nl

Norge

Phone +47 67 81 50 00
E-Mail sick@sick.no

Österreich

Phone +43 (0)22 36 62 28 8-0
E-Mail office@sick.at

Polska

Phone +48 22 837 40 50
E-Mail info@sick.pl

România

Phone +40 356 171 120
E-Mail office@sick.ro

Russia

Phone +7-495-775-05-30
E-Mail info@sick.ru

Schweiz

Phone +41 41 619 29 39
E-Mail contact@sick.ch

Singapore

Phone +65 6744 3732
E-Mail sales.gsg@sick.com

Slovenija

Phone +386 (0)1-47 69 990
E-Mail office@sick.si

South Africa

Phone +27 11 472 3733
E-Mail info@sickautomation.co.za

South Korea

Phone +82 2 786 6321/4
E-Mail info@sickkorea.net

Suomi

Phone +358-9-25 15 800
E-Mail sick@sick.fi

Sverige

Phone +46 10 110 10 00
E-Mail info@sick.se

Taiwan

Phone +886 2 2375-6288
E-Mail sales@sick.com.tw

Türkiye

Phone +90 (216) 528 50 00
E-Mail info@sick.com.tr

United Arab Emirates

Phone +971 (0) 4 88 65 878
E-Mail info@sick.ae

USA/México

Phone +1(952) 941-6780
1 (800) 325-7425 – tollfree
E-Mail info@sickusa.com

More representatives and agencies
at www.sick.com