

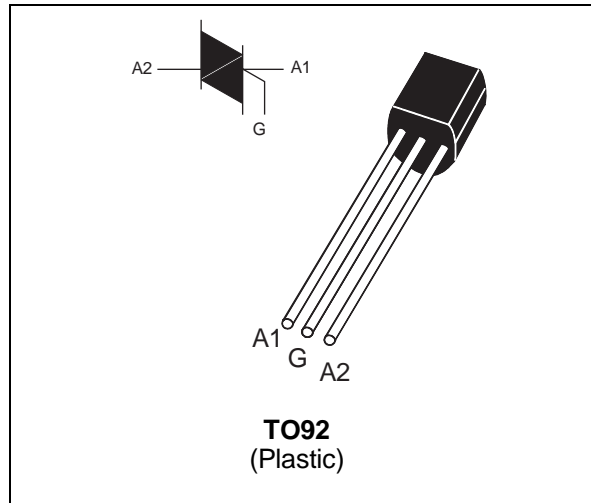
**Z00607MA  
Z00607DA**  
SENSITIVE GATE TRIACS

**FEATURES**

- $I_{T(RMS)} = 0.8A$
- $V_{DRM} = 400V$  and  $600V$
- $I_{GT} = 5mA$

**DESCRIPTION**

The Z006607xA triacs are intended for general applications where high gate sensitivity is required.



**ABSOLUTE RATINGS** (limiting values)

Symbol	Parameter		Value	Unit
$I_{T(RMS)}$	RMS on-state current (360° conduction angle)	$T_I = 50\text{ °C}$	0.8	A
$I_{TSM}$	Non repetitive surge peak on-state current ( $T_j$ initial = 25°C )	$t_p = 8.3\text{ ms}$	10.5	A
		$t_p = 10\text{ ms}$	10	
	Non repetitive surge peak on-state current ( $T_j$ initial = 110°C, full cycle)	$F = 60\text{ Hz}$	8	
$I^2t$	$I^2t$ Value for fusing	$t_p = 10\text{ ms}$	0.5	A <sup>2</sup> s
$T_{stg}$ $T_j$	Storage and operating junction temperature range		- 40, + 150 - 40, + 110	°C
$T_I$	Maximum lead temperature for soldering during 10s		260	°C

Symbol	Parameter	Z00607xA		Unit
		D	M	
$V_{DRM}$ $V_{RRM}$	Repetitive peak off-state voltage $T_j = 110\text{ °C}$	400	600	V

## Z00607DA / Z00607MA

### THERMAL RESISTANCES

Symbol	Parameter	Value	Unit
Rth(j-a)	Junction to ambient	150	°C/W
Rth(j-l)	Junction to lead	60	°C/W

### GATE CHARACTERISTICS (maximum values)

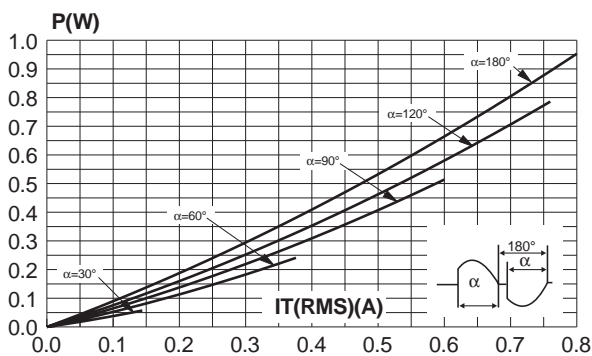
$P_{G(AV)} = 0.1 \text{ W}$   $P_{GM} = 2 \text{ W}$  ( $t_p = 20 \mu\text{s}$ )  $I_{GM} = 1 \text{ A}$  ( $t_p = 20 \mu\text{s}$ )

### ELECTRICAL CHARACTERISTICS

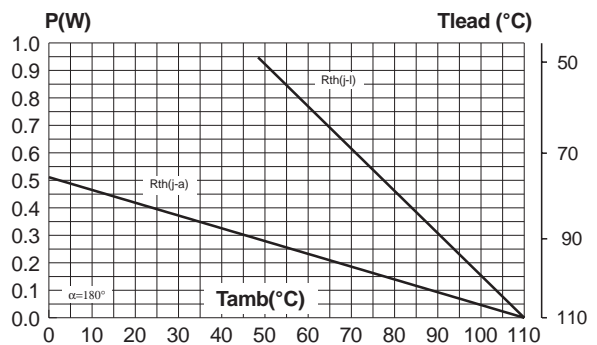
Symbol	Test Conditions	Quadrant		Sensitivity		Unit
				07		
$I_{GT}$	$V_D = 12\text{V (DC)}$ $R_L = 140\Omega$ $T_j = 25^\circ\text{C}$	I-II-III	MAX	5		mA
		IV	MAX	7		
$V_{GT}$	$V_D = 12\text{V (DC)}$ $R_L = 140\Omega$ $T_j = 25^\circ\text{C}$	I-II-III-IV	MAX	1.5		V
$V_{GD}$	$V_D = V_{DRM}$ $R_L = 3.3\text{k}\Omega$ $T_j = 110^\circ\text{C}$	I-II-III-IV	MIN	0.2		V
tgt	$V_D = V_{DRM}$ $I_G = 25\text{mA}$ $I_T = 1.0\text{A}$ $dI_G/dt = 0.25\text{A}/\mu\text{s}$ $T_j = 25^\circ\text{C}$	I-II-III-IV	TYP	2		$\mu\text{s}$
$I_H^*$	$I_T = 200 \text{ mA}$ Gate open $T_j = 25^\circ\text{C}$		MAX	5		mA
$I_L$	$I_G = 1.2 I_{GT}$ $T_j = 25^\circ\text{C}$	I-III-IV	MAX	10		mA
		II	MAX	20		
$V_{TM}^*$	$I_{TM} = 1.1\text{A}$ $t_p = 380\mu\text{s}$ $T_j = 25^\circ\text{C}$		MAX	1.5		V
$I_{DRM}$ $I_{RRM}$	$V_D = V_{DRM}$ $T_j = 25^\circ\text{C}$		MAX	10		$\mu\text{A}$
	$V_R = V_{RRM}$ $T_j = 110^\circ\text{C}$		MAX	0.1		mA
dV/dt *	$V_D = 67\% V_{DRM}$ Gate open $T_j = 110^\circ\text{C}$		MIN	10		V/ $\mu\text{s}$
(dV/dt)c *	(dI/dt)c = 0.35 A/ms $T_j = 110^\circ\text{C}$		MIN	1.5		V/ $\mu\text{s}$

\* For either polarity of electrode A<sub>2</sub> voltage with reference to electrode A<sub>1</sub>

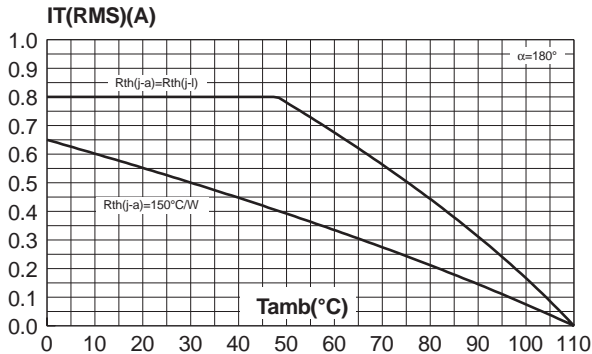
**Fig 1:** Maximum power dissipation versus RMS on-state current.



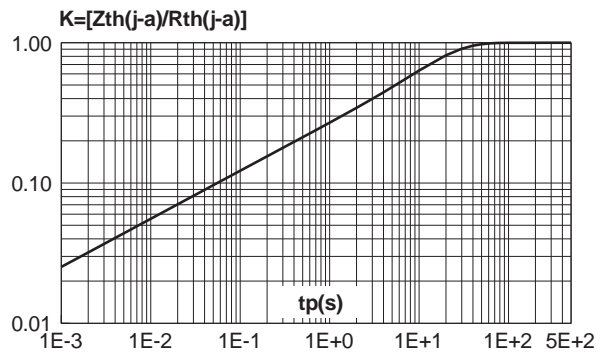
**Fig 2:** Correlation between maximum power dissipation and maximum allowable temperatures ( $T_{amb}$  and  $T_{lead}$ ).



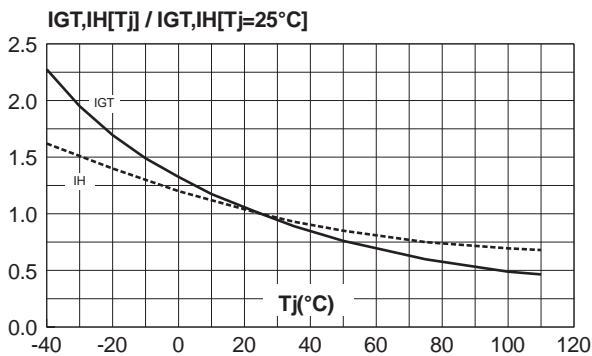
**Fig 3:** RMS on-state current versus ambient temperature.



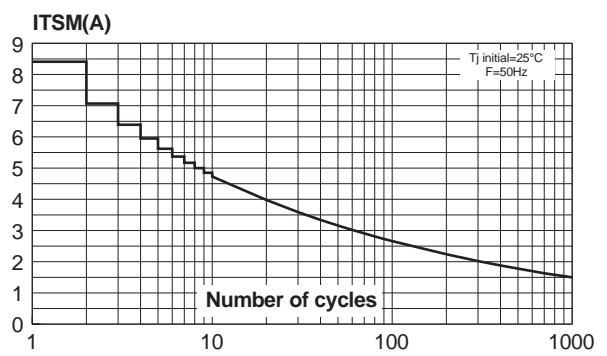
**Fig 4:** Relative variation of thermal impedance junction to ambient versus pulse duration.



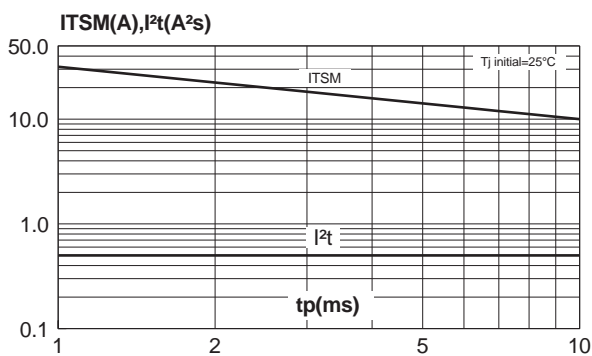
**Fig 5:** Relative variation of gate trigger current and holding current versus junction temperature (typical values).



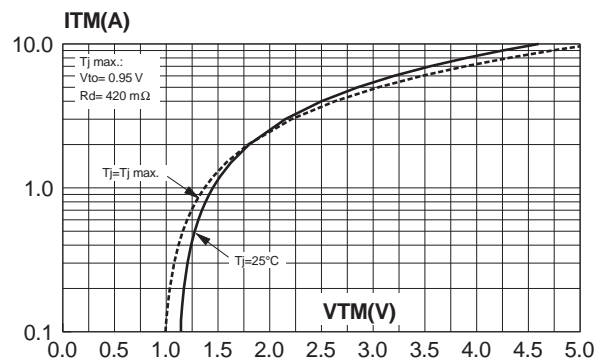
**Fig 6:** Non repetitive surge peak on-state current versus number of cycles.



**Fig 7:** Non repetitive surge peak on-state current for a sinusoidal pulse with width  $tp < 10ms$ , and corresponding value of  $I^2t$ .

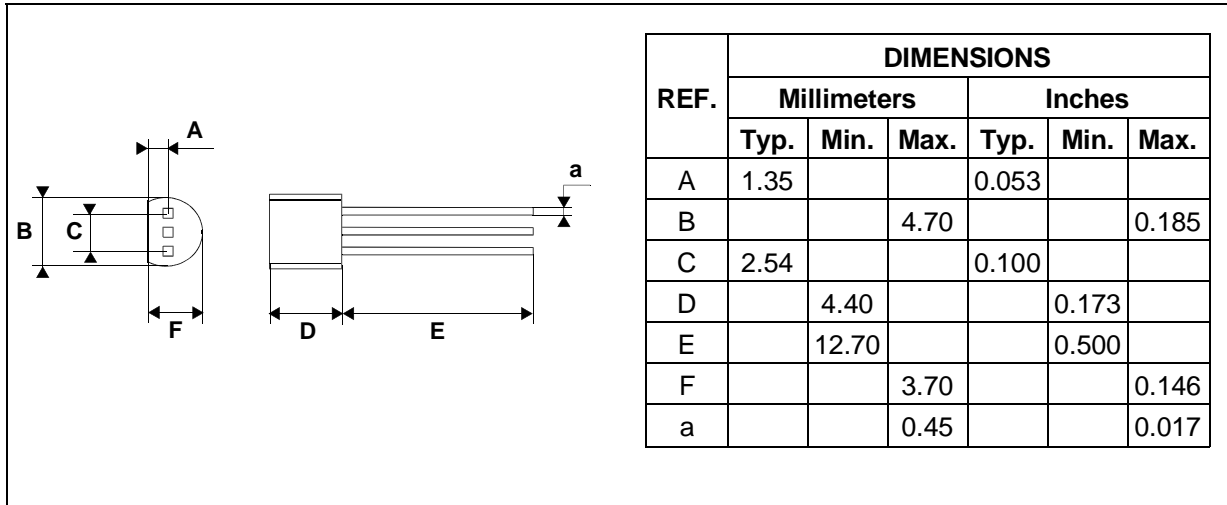


**Fig 8:** On-state characteristics (maximum values).



**Z00607DA / Z00607MA**

**PACKAGE MECHANICAL DATA**  
TO92 (Plastic)



Ordering type	Marking	Package	Weight	Base qty	Delivery mode
Z00607DA 1BA2	Z0607DA	TO92	0.2g.	2500	Bulk
Z00607MA 1BA2	Z0607MA	TO92	0.2g.	2500	Bulk