



ZMD41211

ISO 15693 Wireless Tag IC with Integrated Temperature Sensor

Data Sheet

Rev. 0.7 / September 2008

ZMD41211

Brief Description

The ZMD41211 is a fully integrated passive 13.56 MHz ISO15693-compliant transponder IC with an on-chip temperature sensor and wireless initialization capability. With on-chip timer to establish the log time base and EEPROM to log the sensor data during operation, the ZMD41211 is designed to reduce product spoilage while enhancing the degree of automation and safety in logistics and transportation of goods.

The on-chip EEPROM can be written in downlink direction and read in uplink direction by inductive coupling from a reader. The power is also extracted from the reader through inductive coupling. Due to the on-chip tank capacitor, the ZMD41211 only needs an external coil to communicate with a reader unit.

The on-chip timer unit allows the pre-selection of operating start time and log cycle, hence the log scheme is programmable for a variety of applications.

Features

- Passive transponder with battery powered on-chip temperature sensor, data management unit and timer to log the sensor data/timing product.
- Wireless initialization capability
- Operates at 13.56 MHz with on-chip tank capacitor, rectifier and voltage limiter
- Communication range up to 1 meter
- ISO/IEC 15693 compliant
- 8 kbits EEPROM (720 temperature data)
- Internal real time clock (+/- 3%)
- Internal temperature sensor (+/- 1°C)
- Interface to external humidity sensor
- Multi level password protection
- 8 different log modes

Benefits

- Low cost multifunctional temperature logger, only printed coil and 1.5V Battery needed to build Smart Active Label
- Command set fully compatible with the requirements of ISO 15693 and can communicate with every standard ISO 15693 reader.
- Different sensor functionalities are feasible using a digital interface
- Powerless storage of values

Available Support

- Evaluation Kit available (including board, samples and software)
- Customization of the IC is possible for high-volume requests

Applications

- With the adding of Antenna and Battery to the assembly intended by Smart Active Label.
- Transportation and logistics management of temperature sensitive goods
- Perishable logistics, transportation and storage of pharmaceutical products
- Contactless item identification

ZMD41211 Overview

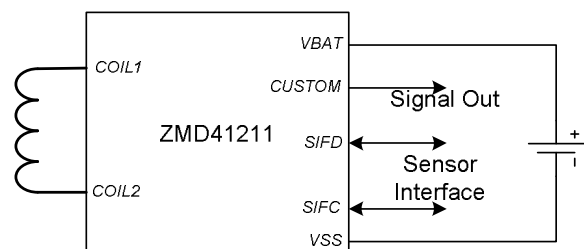

ZMD41211

Contents

Contents	3
List of Figures	4
List of Tables	4
1 Electrical Characteristics	6
1.1. Absolute Maximum Ratings (Non Operating)	6
1.2. Operating Conditions and IC Parameters	7
1.2.1. RFID-Frontend	7
1.2.2. Sensor and Data Logging	8
1.2.3. Characteristics of Digital PINs	9
2 Circuit Description	10
2.1. Signal Flow and Block Diagram	10
2.2. RFID-Frontend	11
2.2.1. Resonance Circuit	11
2.2.2. Modulator / Clamp Circuit	11
2.2.3. Rectifier	11
2.2.4. POR	11
2.2.5. Regulator	11
2.2.6. Clock Extractor	11
2.2.7. Data Extractor	11
2.3. Controller	12
2.3.1. ISO Interface	12
2.3.2. Command Decoder	12
2.3.3. Data and Control Bus	12
2.3.4. Memory Access	12
2.3.5. EEPROM Block	12
2.4. Sensor and Data Logger	12
2.4.1. Timer	12
2.4.2. Temperature Measurement Unit	13
2.4.3. External Sensor Interface	13
2.4.4. Temp-Time-Product-Out, Custom-Out	13
2.4.5. Data Logger Control	13
2.5. Battery Management	13
2.5.1. Battery Measurement Unit	13
3 Functional Description	14
3.1. General Working Mode	14
3.1.1. Passive Transponder Operation	14
3.1.2. Data Logger Operation	14
3.1.3. I ² C Communication	16
3.2. Operation Mode for Data Logging	16
3.2.1. Memory Organization of Logging Data	17
3.2.2. Behavior with Stuffed Measurement Memory	18
3.2.3. Influence of the RF-Field on the Data Logging	18
3.3. Sensor Communication	18
3.3.1. Sensor Protokoll	19
3.4. I ² C-Interface	20
3.4.1. I ² C Commands	21
4 Transponder Commands	26
4.1. Format of Custom Command	26

ZMD41211

4.2.	Command List.....	26
4.2.1.	ISO15693 Compatible Commands	26
4.2.2.	Custom Commands	27
4.3.	Data Security	27
5	Calibration Procedure	29
5.1.	Calibration Block Segmentation.....	29
5.2.	Calibration Principle	31
5.2.1.	Two-Point Calibration.....	31
5.2.2.	Three-Point Calibration	34
5.3.	Cyclic Redundancy Check (CRC) Calculation for Validation of Calibration Data.....	35
5.4.	Calibration Flow	36
5.4.1.	Calibration via Wireless Communication.....	36
5.4.2.	Calibration via I ² C-Interface.....	38
6	Memory Map.....	40
7	Pin Configuration and Package	41
7.1.	Pin Configuration.....	41
7.2.	Pin/Pad description	42
7.3.	CHIP Layout.....	43
8	Application Notes.....	44
8.1.	Connection of External Sensor.....	44
8.2.	Antenna Layout.....	44
9	Additional Documents	45
10	Glossary.....	46
11	Document Revision History.....	47

List of Figures

Figure 2.1	ZMD41211 Architecture	10
Figure 3.1	Log Mode – Measurement Differentiation	16
Figure 3.2	SIFC, SIFD Pad Application	21
Figure 3.3	I ² C Communication Sequence.....	22
Figure 5.1	Temperature Calibration Point Location.....	31
Figure 5.2	Battery Voltage Calibration Point Location.....	33
Figure 5.3	Illustration of 3-Point Calibration.....	34
Figure 5.4	Typical Settling Behaviour.....	37
Figure 6.1	EEPROM Overview – Quasi-Permanent Data	40
Figure 6.2	EEPROM Overview – Measurement Data	40
Figure 7.1	Pin-out Diagram	41
Figure 7.2	Chip Layout.....	43
Figure 8.1	Schematic with Sensor (left) and with Annunciator (right)	44
Figure 8.2	Antenna Layout Example	44

List of Tables

Table 1.1	Absolute Maximum Ratings.....	6
Table 1.2	General Operating Conditions	7
Table 1.3	Characteristics of Logging Systems.....	8
Table 1.4	Current Consumption and Temperature Measurement Properties	8



ZMD41211

Table 1.5	Timer Oscillator Details	8
Table 1.6	Driver Capability.....	9
Table 1.7	EEPROM Characteristics	9
Table 3.1	Log Mode Summary	17
Table 3.2	Command Sequence for IC Initialization.....	23
Table 3.3	Command Sequence for Temperature Measurement Unit (BMU) Activation	23
Table 3.4	Command Sequence for Writing User/Temperature Data EEPROM	24
Table 3.5	Command Sequence for User/Temperature Data EEPROM Readout.....	25
Table 3.6	Command Sequence for Timer Oscillator Activation Sequence	25
Table 4.1	ISO Commands	26
Table 4.2	Custom Commands	27
Table 4.3	Access Rights According to Password Usage.....	28
Table 5.1	Structure of Block 05 for Calibration Data	29
Table 5.2	Structure of Block 06 for Calibration Data	29
Table 5.3	Structure of Block 07 for Calibration Data	30
Table 5.4	Byte fragmentation of Calibration Blocks	35
Table 5.5	Command Format of SET CAL.....	36
Table 5.6	Command Response when Error Flag is set.....	36
Table 5.7	Command Response when Error Flag is not set.....	36
Table 5.8	Command Sequence for Temperature Measurement Unit (TMU) Activation	38
Table 5.9	Command Sequence for Writing Parameter-EEPROM	39
Table 5.10	Command Sequence for Parameter-EEPROM Readout.....	39
Table 7.1	Pin List.....	42

ZMD41211

1 Electrical Characteristics

1.1. Absolute Maximum Ratings (Non Operating)

The maximum rating parameters and limits, respectively, define the outer range of electrical or thermal resistibility of the IC. In this section, the parameters' limits do not reflect limits of operation.

Table 1.1 Absolute Maximum Ratings

Symbol	Parameter	Min	Max	Unit	Conditions
$V_{\text{coil1}} - V_{\text{coil2}}$	Coilpad voltage	-8.5	8.5	V	
I_{coil}	Maximum coil current	-40	40	mA	
V_{bat}	Battery Voltage	-0.3	3.6	V	
V_{DD}	CUSTOM Out	-0.3	$V_{\text{bat}} + 0.3$	V	
V_{outC}	SIFC (open drain)	-0.3	3.6	V	
V_{outD}	SIFD (open drain)	-0.3	3.6	V	
T_{STG}	Storage Temperature	-55	125	°C	
V_{ESD}	ESD capability at pins, except for $V_{\text{pp1/2}}$	-2	2	kV	Electrostatic discharge (ESD) Model: <i>Human Body Model</i> (HBM)
T_{STG}	Storage Temperature	-55	125	°C	
I_{in}	Input current into any pin (latch-up protection)	-100	+100	mA	@ $T_{\text{amb}} = 100\text{ °C}$

PRELIMINARY

ZMD41211

1.2. Operating Conditions and IC Parameters

All voltages are referenced to V_{SS} if not noted otherwise.

1.2.1. RFID-Frontend

Table 1.2 General Operating Conditions

General	Symbol	Condition	Min.	Typ.	Max.	Unit
Operating temperature			-40		85	C
Frequency of operation			13.553	13.56	13.567	MHz
Supply voltage (regulated) digital part	V_{DD}		1.1	1.2	1.35	V
Operating current out of regulator	I_{DD}				100	μ A
Resonance Circuit						
Resonance capacitor	C_{res}		28		28.3	pF
Operating magnetic field	H		0.15		5	A/m rms
Resulting quality factor of tank circuit	Q			50		
Modulator / Clamp						
Clamp voltage limit	$V_{coil1} - V_{coil2}$	$I_c=150\mu$ A	5.2	6.2		V
		$I_c=15$ mA		6.8	8.0	V
Coil-pad voltage during modulation	V_{coil1}, V_{coil2}	$I_c=100\mu$ A	1	2.1	2.5	V
		$I_c=15$ mA		3.5	4.5	V
Rectifier						
Rectifier voltage drop	$(V_{coil1}-V_{coil2})-V_{sup}$	$I_{sup}=10\mu$ A		0.7		V
Supply capacitor	C_{sup}			300		pF
Power Enable Threshold						
Power enable start	V_{sup}	$V_{coil2}=V_{SS}$	2.3	2.6	2.85	V
	V_{coil1}		2.6	3.3	4.0	V
Power enable stop	V_{sup}	$V_{coil2}=V_{SS}$	2.1	2.4	2.65	V
	V_{coil1}		2.5	3.1	3.9	V

ZMD41211

1.2.2. Sensor and Data Logging

Table 1.3 Characteristics of Logging Systems

General	Symbol	Condition	Min.	Typ.	Max.	Unit
Operating temperature			-30		60	°C
Storage temperature with permanent applied battery	T_{STG}		-45		60 ⁽¹⁾	°C
Battery voltage	V_{bat}		1.15 ⁽²⁾	1.3	1.55	V
Single data points storable					720	

Annotations:

- ⁽¹⁾ With 80 °C, the idle current increases by 10 times compared to ambient temperature; therefore only short term storage temperature excess to 80 °C is recommended.
- ⁽²⁾ To maintain all parameters only with $V_{bat} > 1.15V$; with $V_{bat} = 1.1V$ full function is ensured, however slight parameter excesses are possible.

Table 1.4 Current Consumption and Temperature Measurement Properties

Current consumption at V_{bat}	Symbol	Condition	Min.	Typ.	Max.	Unit
Idle current, timer off	I_{bat}	Temp = 20 °C		80	200	nA
Timer on, no temp measurement	I_{bat}	Temp = 20 °C	1.0	1.4	2.5	µA
Temp measurement and EEPROM write	I_{bat}	duration <0.5s		150		µA
Temperature measurement						
Temperature range			-30		50	°C
Resolution			0.13	0.2	0.3	°C
Accuracy as deviation from the calibration value		after 2-point Calibration	-1.0		+1.0	°C

A 2-Point-Calibration process determines the accuracy of temperature. During wafer or device test, the calibration values can be determined and stored in the EEPROM. Please contact ZMD for incorporating the respective customization.

Table 1.5 Timer Oscillator Details

Timer	Symbol	Condition	Min.	Typ.	Max.	Unit
Oscillator frequency	f			8.2		kHz
Accuracy	f_acc	-30...+50 °C	-3.0		+3.0	%
Programmable time interval	LTIMI	duration <0.5s	2		32766	sec

ZMD41211

1.2.3. Characteristics of Digital PINs

Sensor interface PINs SIFC/SIFD are open drain Input-Output-PINs with ESD protection to V_{SS} . The CUSTOM-PIN is a tristate-typed CMOS-output with ESD protection to V_{SS} and V_{bat} .

Table 1.6 Driver Capability

SIFD and SIFC	Symbol	Condition	Min.	Typ.	Max.	Unit
Maximum high level	V_{OUT_MAX}				3.3	V
External clock signal	CLK_max				200	kHz
DC-current at open drain on	I_{OL1}	$V_{OL1}=0.1V$	295		445	μA
DC-current at open drain on	I_{OL2}	$V_{OL2}=0.2V$	535		805	μA
DC-current at open drain off	I_{HIZ}	$V_{OUT}=1.5V$	-1		+1	μA
CUSTOM						
DC-current at CUSTOM = Low	I_{OL}	$V_{OL}=0.2V$	540		785	μA
DC-current at CUSTOM = High	I_{OH}	$V_{OH}=V_{bat}-0.2V$	210		310	μA
CUSTOM = tristate	I_{HIZ}	$V_{OUT}=0\dots V_{bat}$	-1		+1	μA

Table 1.7 EEPROM Characteristics

Symbol	Parameter	Min	Typ	Max	Unit	Conditions
t_{dataR}	Data retention	10	-	-	a	@ T_{amb} as specified for Consumer or Industrial range
	Cycling endurance	100000	-	-	cycles	

ZMD41211

2 Circuit Description

2.1. Signal Flow and Block Diagram

The ZMD41211 combines an ISO 15693 compliant 13.56MHz transponder with data logging system and on-chip temperature monitor or external sensor input.

The coil of the LC tank is the only external component needed to enable wireless communication. An additional battery is necessary for the supply of the Data Logger. A special idle mode is supported, such that the battery can remain constantly connected. All operating modes are controllable by wireless commands.

Figure 2.1 ZMD41211 Architecture

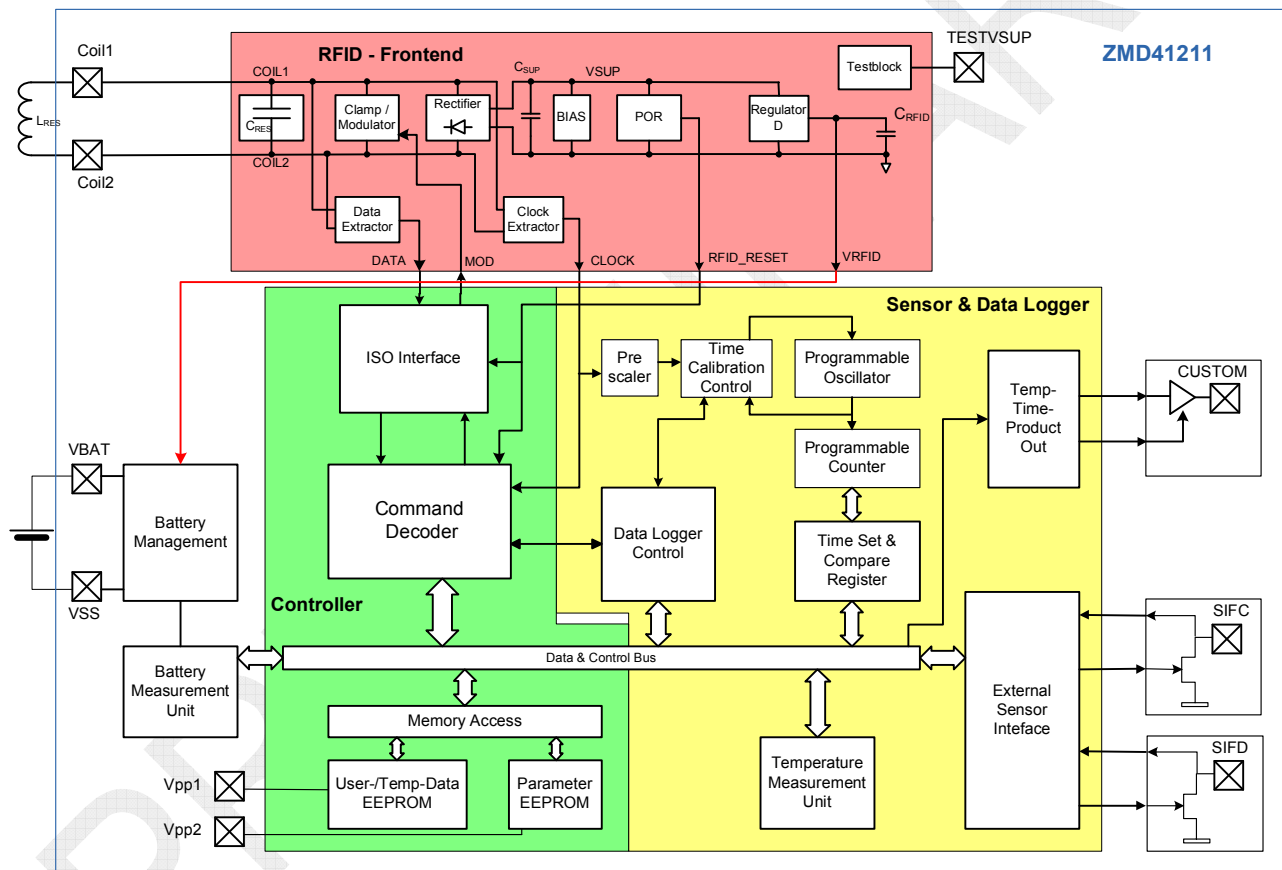

ZMD41211

2.2. RFID-Frontend

The RFID-Frontend contains all functions for power generation, voltage protection and data extraction. It obtains its power solely from the received magnetic field.

2.2.1. Resonance Circuit

The input L-C tank has to be in resonance with the operating frequency f_c . The quality factor Q should be high enough to provide a sufficient operating voltage. Q should not exceed a certain limit such that enough energy is available for the operation of the transponder especially also at the tolerance limits of the transmission frequency.

2.2.2. Modulator / Clamp Circuit

The clamp circuit will protect the IC from over voltages. At weak magnetic field conditions, it is not allowed to consume more than a specified maximum current. At strong field conditions the clamp circuit has to draw a specified minimum current to load the tank more intensively and limits the input voltage.

The circuit will also be used for load modulation. If the modulation signal is on, the input voltage will not be allowed to drop that far such that the clock extractor stops working. With a high coil pad current (strong field situation), the modulator-on input voltage must drop to a value well below the clamp voltage to allow for modulation detection by the reader device.

2.2.3. Rectifier

The rectifier has to perform a full wave rectification of the input voltage at the operating frequency. If V_{sup} exceeds the input voltage, C_{sup} will not be allowed to discharge via the rectifier.

2.2.4. POR

The Power-On-Reset will enable the digital core if a threshold voltage V_{sup} is reached. If V_{sup} drops below a second lower threshold, the IC will enter reset mode.

2.2.5. Regulator

The regulator provides constant voltages VRFID from V_{sup} . It provides a supply voltage to the controller unit via battery management.

2.2.6. Clock Extractor

The clock extractor generates a 13.56 MHz clock from the input voltage as soon as the latter exceeds a specified threshold. If the input voltage drops due to modulator action, the clock signal will remain stably. If the data extractor receives a gap (100% modulation), the clock signal will stop.

2.2.7. Data Extractor

The data extractor will detect reader modulation gaps. It accepts only those gaps which are in accordance with the tolerances described in ISO 15693-2 and supports both, 100% and 10% modulation. The data extractor operates reliably over a wide dynamic range.

ZMD41211

2.3. Controller

The Controller unit works with power from magnetic field or will be powered from an external Battery.

2.3.1. ISO Interface

To fulfill the ISO 15693 standard, the logic unit performs an anti-collision function, CRC, on outgoing and incoming commands, ASK/FSK-Modulation and Start/End-Of-Frame detection/generation.

2.3.2. Command Decoder

The command decoder interprets the reader's commands and generates control signals for the Data Logger Control to control the main section Sensor & Data Logger.

2.3.3. Data and Control Bus

The data bus transmits write/read data between command decoder and EEPROM as well as the temperature's time stamp of the Data Logger.

2.3.4. Memory Access

This functional unit acts as an interface to write and read the EEPROM. It calculates addresses and manages access permissions of the memory block.

2.3.5. EEPROM Block

For storing measuring data, an 8kBit EEPROM is implemented being divided into two sub-arrays internally:

- the Parameter-Array being organized in 16 blocks of 32Bits each and
- the User/Temperature data-array consisting of 240x32Bits.

Priority write read access is possible during transponder communication in the magnetic field. With activated data logging, temperature data is written to the data-array.

A charge pump is integrated. Its internal pump voltage is observable at pad Vpp1/2 only by wafer test.

2.4. Sensor and Data Logger

The main section: Sensor & Data Logger is powered exclusively by the battery. It contains a timer, the Temperature Measurement Unit, an External Sensor Interface, the Temp-Time-Product-Out and a control unit.

2.4.1. Timer

A timer is integrated which generates the internal time base. The time base is adjustable and contains a programmable counter/oscillator, the Time Set & Compare Register and a Time Calibration Control. The frequency of the oscillator is calibrated to be 8kHz by means of trim registers. Latter are transferred from the memory when the timer starts. Pre-selection time and interval time are stored in the Time Set & Compare Register. Thus a starting time is given, from which the interval timer counts with fixed time steps.

ZMD41211

Moreover, a special feature is implemented: the timer's synchronization to the highly precise 13.56MHz carrier frequency. Therefore the RFID clock is adapted to the target frequency via the Prescaler. Based on that, the internal oscillator is synchronized to the target frequency of 8kHz.

2.4.2. Temperature Measurement Unit

The Temperature Measurement is started by the unit: Data Logger Control. The Data Logger Control receives the request from the interval timer after expiration of the interval for a new measurement. Then the 10bit measured value is written to the EEPROM. The custom command reads out the counter value from the User/Temperature Data EEPROM and calibration parameters from the Parameter-EEPROM. At the reader-side, the respective register value has to be interpreted as temperature.

2.4.3. External Sensor Interface

On the one hand the interface enables the connection of an external humidity sensor via an I²C-like transmission protocol. On the other hand a circuit test of this block can be conducted. The External Sensor Interface connects Open-Drain-IN/OUT SIFC (I²C-clock) and SIFD (I²C-Data) directly. Furthermore, external pullup resistors are additionally integrated to support sensors with higher operating voltages.

2.4.4. Temp-Time-Product-Out, Custom-Out

This functional unit calculates the product of time and temperature continuously during data logging. There will be a low-high-transition, if a preset temperature-time-product is exceeded.

2.4.5. Data Logger Control

With a custom command the Data Logging cycle can be started or stopped. The control unit gets all relevant initial parameters from the memory, preloads the registers and starts the Data Logging.

2.5. Battery Management

Dependent on: main states idle, logging, recording and transponder communication, different blocks are activated and a power-on-reset control is realized. Power supply VRFID and external battery are switched to controller and Data Logger.

2.5.1. Battery Measurement Unit

The charge of the battery can be observed with the connected Battery Measurement Unit.

In case of a voltage fall-off below a certain limit an erroneous temperature measurement is prevented and a flag is stored. The voltage result is represented as 6-Bit count in a register and can be fetched by means of a custom command. Battery measurements can be triggered by a single custom command as well as during Data Logging.

ZMD41211

3 Functional Description

3.1. General Working Mode

There are three general application types of the ZMD41211:

1. Operation as passive transponder (i.e. Tag) with a connected coil;
2. The operation as Data Logger which requires an additionally connected battery (with about 1.5V). This is the intended main application type. The temperature sensor and the Data Logger will be active here. If an additional sensor with (modified) I²C functionality is applied, its data will be also considered during the logging process.
3. The operation only with a connected battery (without coil) enables the test mode and provides the possibility for an I²C-communication via SIFC, SIFD and CUSTOM.

3.1.1. Passive Transponder Operation

The operation with a coil allows for wireless communication according to ISO 15693 standard. Communication between reader and tag complies with the following steps:

- Powering up the Tag by the RF operating field, generated by the reader;
- Tag waits in idle mode;
- Reader sends a command (request);
- Tag responds to the command (response).

The transponder is designed to operate with a 13.56MHz carrier frequency. Communication between the reader and the transponder (Down-Link communication) takes place using an ASK modulation index between 10% and 30% or 100% and data coding (pulse position modulation) "1 out of 4" or "1 out of 256".

According to ISO 15693 Up-Link communication (Transponder to Reader) can be accomplished with one subcarrier (ASK modulation) or with two subcarrier (FSK modulation). Both modes (ASK and FSK) can operate with either high or low data rate. The transponder answers in the mode it was interrogated from the reader and supports all communication parameter combinations. Up- and Down-Link are frame synchronized and CRC check sum secured.

A complete access to the User/Temperature Data EEPROM is possible. Moreover the Parameter-EEPROM can be accessed using the custom commands.

3.1.2. Data Logger Operation

The module Sensor & Data Logger is powered by the supply voltage from the battery. The establishment or termination of wireless communication via the RFID-frontend starts and stops the Data Logger, respectively.

Data Logging is mainly the processing and storage of temperature measurement at equidistant time steps. The mean value of these measurements will be buffered. According to the Logging method, the respectively buffered value will be compared and combined with previous values or it will be stored in the EEPROM (together with the respective time stamp) directly.

The Data Logging flow is exclusively only controlled by custom commands. At first, the initialization command erases the data EEPROM which is divided into customer and temperature section. Afterwards the operation parameters have to be entered being followed by the customer data. Then, the start command will start the timer and the logging parameter will be transferred to the flow control. Overwriting of the logging parameters will change the memory content but not the flow control.

ZMD41211

In-between, data requests or stopping the Data Logging are possible during the monitoring period. In logging mode, all temperature and sensor data will be stored at equidistant time steps. After the expiration of the intended log-time, the RFID-field (at the reader) must be switched on and the coil must be within the RFID-field, respectively. The temperature data can be read out and the stop command will switch off the timer. Then, a new initialization command will prepare the IC for a new measurement run.

Recommendation Command Flow Data Logging

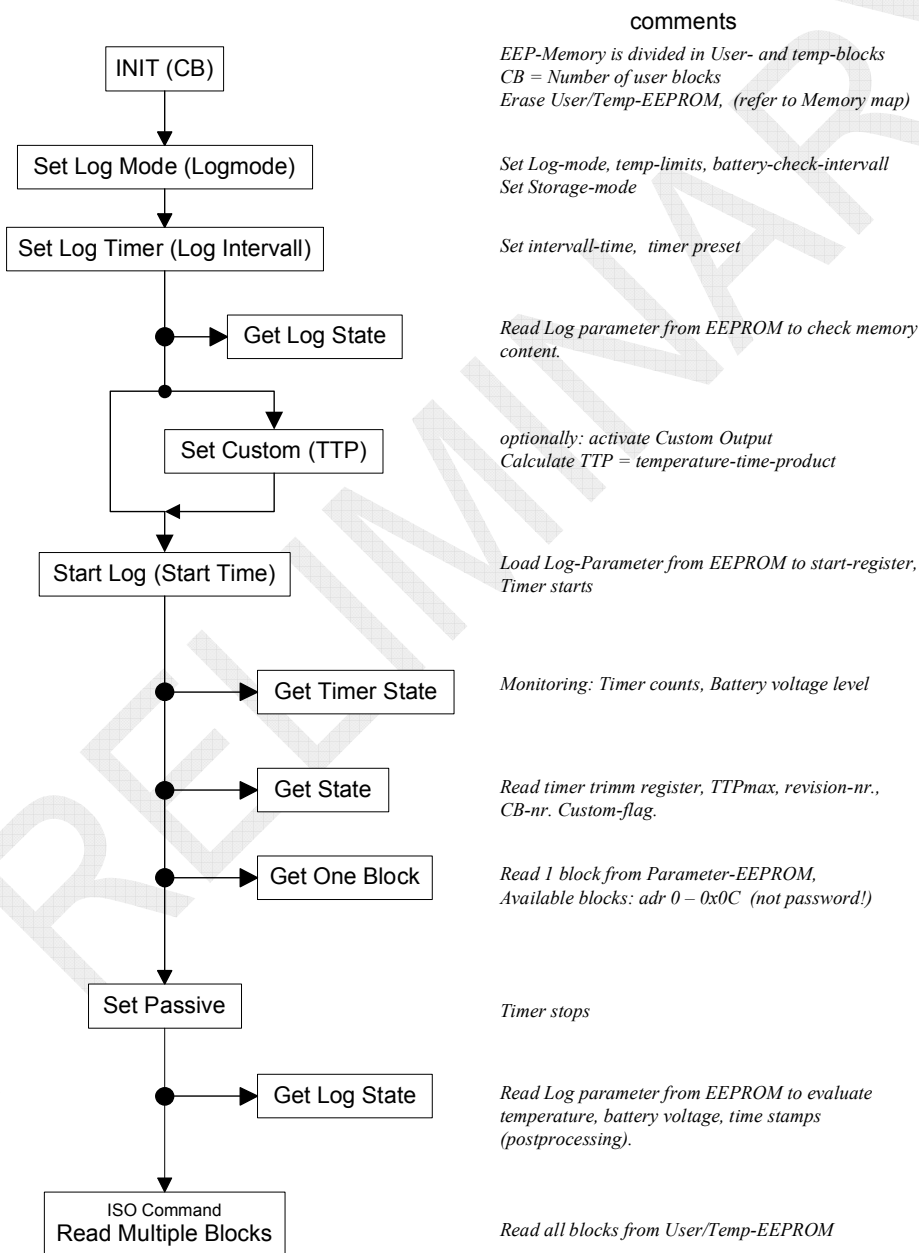

ZMD41211

3.1.3. I²C Communication

The digital I²C interface is accessible via the pins: SIFC (clock) and SIFD (bi-directional data). The interface provides two general functionalities:

1. The transmission protocol slightly differentiates from the I²C-standard when the IC operates as Data Logger. At each start of the Data Logger, the recognition sequence is send from the master to the external sensor via the SIFD pad. The data line has to be high in this case. Thereafter the communication is established and external sensor measurements are stored like for the internal temperature measurement. A detailed description on that can be found in section 3.3.
2. An I²C-slave is integrated for the sake of IC testing or for temperature calibration purposes. The I²C-slave can be accessed via two internal device addresses. The Temp/Battery Measurement Unit, the Timer Oscillator and Read/Write of the EEPROM can be accessed for this way (see section 3.4 for further details).

3.2. Operation Mode for Data Logging

The complete measurement rang is divided into Good and Corrupted. The definition of an upper and lower measurement limit yields a band with Good-values (green region in Fig. 3.1). Hence, there will be three scenarios of measurement as depicted in Fig. 3.1. The diagram can be interpreted extendedly if an external sensor was applied.

Figure 3.1 Log Mode – Measurement Differentiation

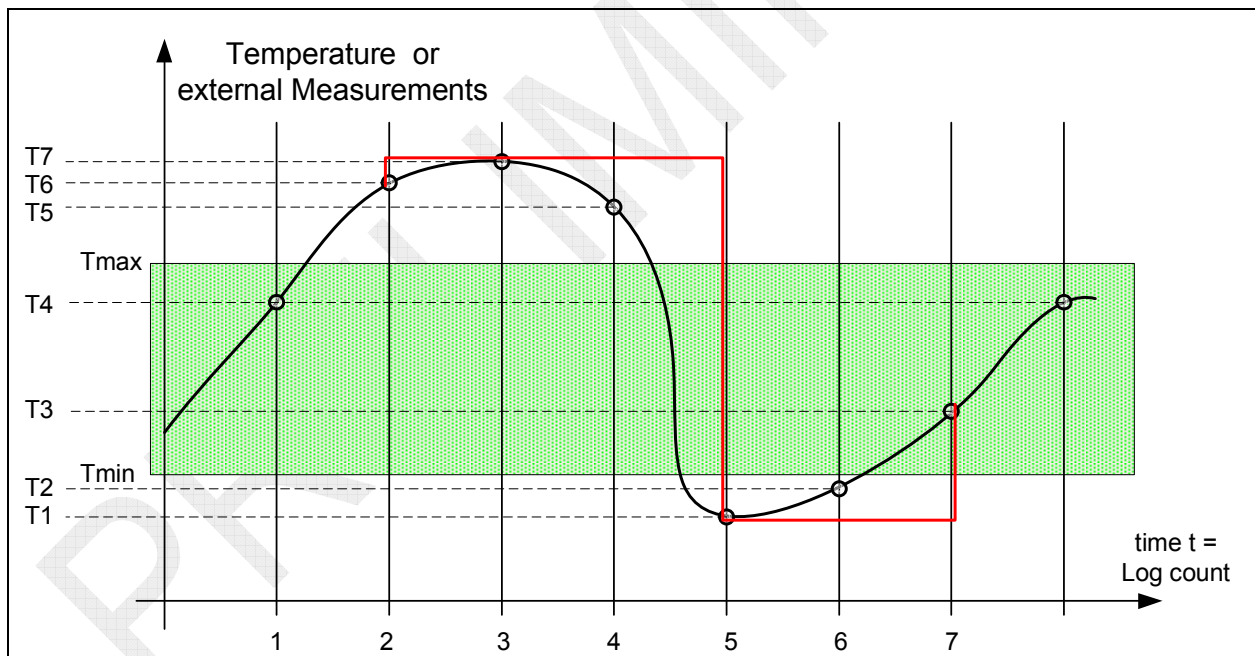

ZMD41211

The different Logging Modes are:

- Log Mode 0: Record measurements beyond the limits: {(T6, t2), (T7, t3), (T5, t4), (T1, t5), (T2, t6)}, whereas the limits are only valid for exclusively only one of the two possible sources
- Log Mode 1: Record all measurements and time stamps: {(T4, t1), (T6, t2), ...};
- Log Mode 2: Record measurements beyond the limits: {(T6, t2), (T7, t3), (T5, t4), (T1, t5), (T2, t6)};
- Log Mode 3: Record measurements beyond the limit with 3 value pairs (1st limit exceeding, extremum, 1st re-entry) : {(T6, t2), (T7, t3), (T1, t5)} ; {(T1, t5), (T1, t5), (T3, t7)}.

Moreover the following operation modes can be realized:

- Save measurements from internal temperature sensor:
Operation Mode 1-3;
- Save measurements from external sensor (e.g. humidity sensor):
Operation Mode 5-7;
- Save measurements from both, internal and external sensor concurrently:
Operation Mode 4 and 8 ... dependent on the defined limits of the respective sensor.

Generally, it is to distinguish between taking measurements in different measurement scenarios (Log Mode) as in Fig. 3.1 and taking measurements from different sources, i.e. internal or external sensor or both (Operation Mode). Log Mode 0 is an exception from that logical hierarchy. Here, the limits according to Log Mode 2 are considered for one measurement source (i.e. external sensor or internal temperature sensor) but both of the measurements are saved, though.

Table 3.1 Log Mode Summary

Operation Mode	External Sensor	Log Mode	Description
1	no, EXT=0	1	Measure temperature, save all values, max. 720 values
2	no, EXT=0	2	Measure temperature, save all values beyond limit, max. 240 values
3	no, EXT=0	3	Save temperature & extremums, max. 240 values
4	yes, EXT=0	0	For temperature & external sensor, save all values beyond temp.-limit, max. 240 temperature values and 240 values from external sensor
5	yes, EXT=1	1	Measure via external sensor, save all values, max. 720 values
6	yes, EXT=1	2	Measure via external sensor, save all values beyond limits, max. 240 Values
7	yes, EXT=1	3	External, save extremums, max. 240 values
8	yes, EXT=1	0	For temperature & external sensor, save all values beyond the external-limit, max. 240 temperature values and 240 values from external sensor

Log Mode and EXT = 1/0 are elements of the Log Parameter (cp. ZMD41211 Command Description).

3.2.1. Memory Organization of Logging Data

Due to the multi-purpose ways for saving logging data, there are two different parameters for memory organization:

1. the log-data address, LGAD provides the pointer to the next memory block's address and

ZMD41211

- the log-counter, LCNT counts the number of conducted measurements.

These parameters are determined by the Data Logger Control and are saved in the EEPROM block 0B_H. Additionally a dedicated part of the memory is preserved for customer data covering a certain number, CB of memory blocks. CB divides the User/Temperature Data EEPROM into two partitions (see Memory Map). The start address is obtained by: $start_address = LGAD = 10_H + CB$.

In Log Mode 1, three measurements are written to one memory address in each case, whereas the writing to the User/Temperature Data EEPROM is realized after the completion of the respective three measurements. Thereupon LGAD is incremented once and LCNT is incremented three times. In parallel, the block 06_H refreshed.

Multiple overwrites of measurement data (within the block addresses: 10_H+CB until FF_H) is possible and can be selected by the State Log Memory Overwrite, SLMO in block 0A_H. An overflow counter, LMO will be activated, if the dedicated overwriting of memory is selected. LMO is located in block 0B_H.

In the Log Modes 0, 2 and 3, not any measurement value will be considered. A memory block address will be overwritten for exceeding a limit per measurement value. Furthermore the respective LCNT-value will be saved at this address. The block 0B_H will be refreshed after each measurement.

3.2.2. Behavior with Stuffed Measurement Memory

Logging will be stopped, i.e. no measurement will be conducted as soon as it holds:

- No overwriting at SLMO=0 and LGAD=FF_H (LMO=0) or
- Overwriting allowed SLMO=1, LCNT=3FFF_H or LMO=3F_H.

The log parameter will remain at their maximum level. The timer will keep on running. The flag log_stop will be set 1 (this flag is bit[15] in block 0B_H). Data logging must be stopped manually by the custom command: "Set Passive".

3.2.3. Influence of the RF-Field on the Data Logging

Pending measurements will be postponed, if the transponder is logging data and enters the RF-field. When the RF-field will have been left, all missing measurement results are replaced by zero values.

At the beginning of a measurement, it is verified whether this measurement was postponed more than 0.5s. If this is the case, no measurement will be conducted and the value: 0 will be saved, regardless on the set up operation and measurement mode. Only the external measurement value will be set to 0 for modes with internal and external measurements – the internal measurement will be undefined then.

3.3. Sensor Communication

The external sensor is connected to the ZMD41211 via SIFC and SIFD. The ZMD41211 acts as master, generates the clock, requests and fetches data by respective commands.

Thereby, the logging parameter EXT determines whether the extremums, T_{min} and T_{max} (cp. Fig. 3.1) are referred to the internal temperature sensor (EXT = 0) or to the external sensor (EXT = 1).

SIFC and SIFD should be at VSS level, if no external sensor is applied.

ZMD41211

3.3.1. Sensor Protokoll

Moreover the ZM41211 comes with a specially designed transmission protocol for a dedicated sensor, details available on request.

During the communication, Reset Sequence, Start Sequence and Data Transfer are distinguished from each other. Any transmission is initiated by Reset and Start Sequence from the ZMD41211. A configuration byte is transmitted to the sensor with the very first initialization. Afterwards, only measurements are conducted which are controlled by the respective measurement command to the sensor. The master sets the clock signal to Low and the Data line to High and waits for measurement completion. The latter is indicated by the High-Low transition of the data line (realized by the sensor) being followed by the transmission of the measurement data from sensor to the ZMD41211. An acknowledge is generated by the ZMD41211/Sensor after the transmission of 8 bit of data by drawing the data line to Low for one bit. In case of lost synchronization, the master can reset the interface with the Reset Sequence.

3.3.1.1. Reset Sequence

The Reset Sequence consists of 9 L/H/L clock transitions, whereas the data line (SIFD) is High. The Reset Sequence re-initializes the communication interface.

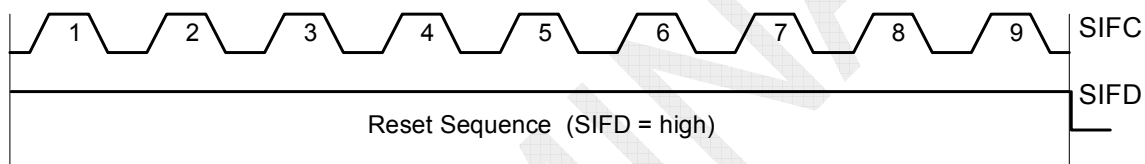

3.3.1.2. Start Sequence

The Start Sequence consists of 2 L/H/L clock transitions. The data line turns from High to Low during the 1st clock high phase and back, from Low to High during the 2nd clock High phase.

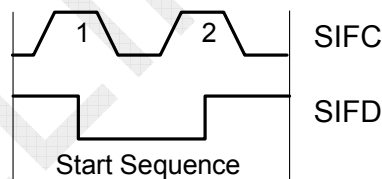

3.3.1.3. Data Transfer to Sensor

The change of data bits between High and Low (on SIFD) may occur in the clock Low phase for data transfer to the externally connected sensor. During the High phase of clock (SIFC), the data bits are considered as valid and will be transferred. The external sensor will acknowledge the data reception with the ninth bit on the data line, SIFD.

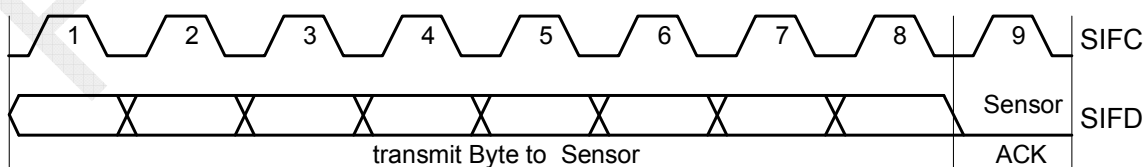

ZMD41211

3.3.1.4. Data Transfer from Sensor

The data transmission from sensor to the ZMD41211 is comparable to the data transfer to the sensor except the communication's roles. Data bit changes may occur during the (SIFC) clock Low phase. The respective bits are considered at the clock High phase. The ZMD41211 will acknowledge the receiving of the data byte with Low level of bit[9]. The communication will be stopped with the last byte being received whereas no acknowledge will be provided (for the last data byte).

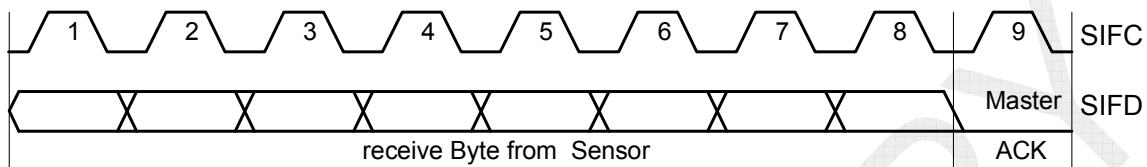

3.3.1.5. Data Frame

The complete Data frame comprises the following:

1. Reset Sequence – Start Sequence – Send 06_H – Send 01_H
2. Reset Sequence – Start Sequence – Send 05_H – <wait for ready> – Read XX_H – Read XX_H
3. ...

Reading of data (step 2.) will always be repeated during Logging. The communication will be interrupted by the master after the receiving of the last byte. The stopping interruption is realized by omitting the last acknowledge. Data and commands are transferred MSB first. In normal case, the first received byte is zero.

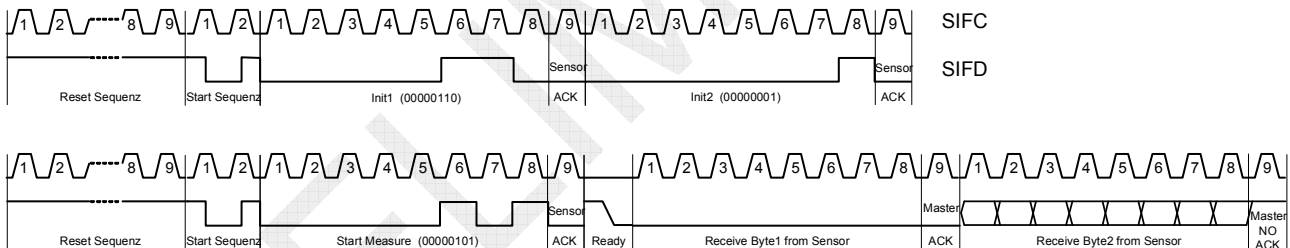

3.4. I²C-Interface

A two-wire interface is built up by the bi-directional pads: SIFC and SIFD. The respective lines have to be load by supply via external pull-up resistances (of 10kΩ to 500kΩ each). Thereby the external sensor and an external I²C master, respectively, can be run at an extended supply voltage range of 1 V to 3.3 V. The connection of a coil is not required but possible communication.

An external control device has to take over the I²C-master role. This device must generate and communicate the control commands to access the EEPROM and internal Measurement Units. The usage of an external control device excludes the working mode: Data Logger!

In Figure 3.2, connection options for I²C-compliant applications are shown.

ZMD41211

The frequency range of the I²C-clock (pad SIFC) depends on the capacitive load. A clock (10kHz – 200kHz range) is recommended to ensure optimum operation. Additionally, the ZMD41211 contains the CUSTOM-pad which is a tristate-capable monitoring output. It can be activated if required.

Figure 3.2 SIFC, SIFD Pad Application

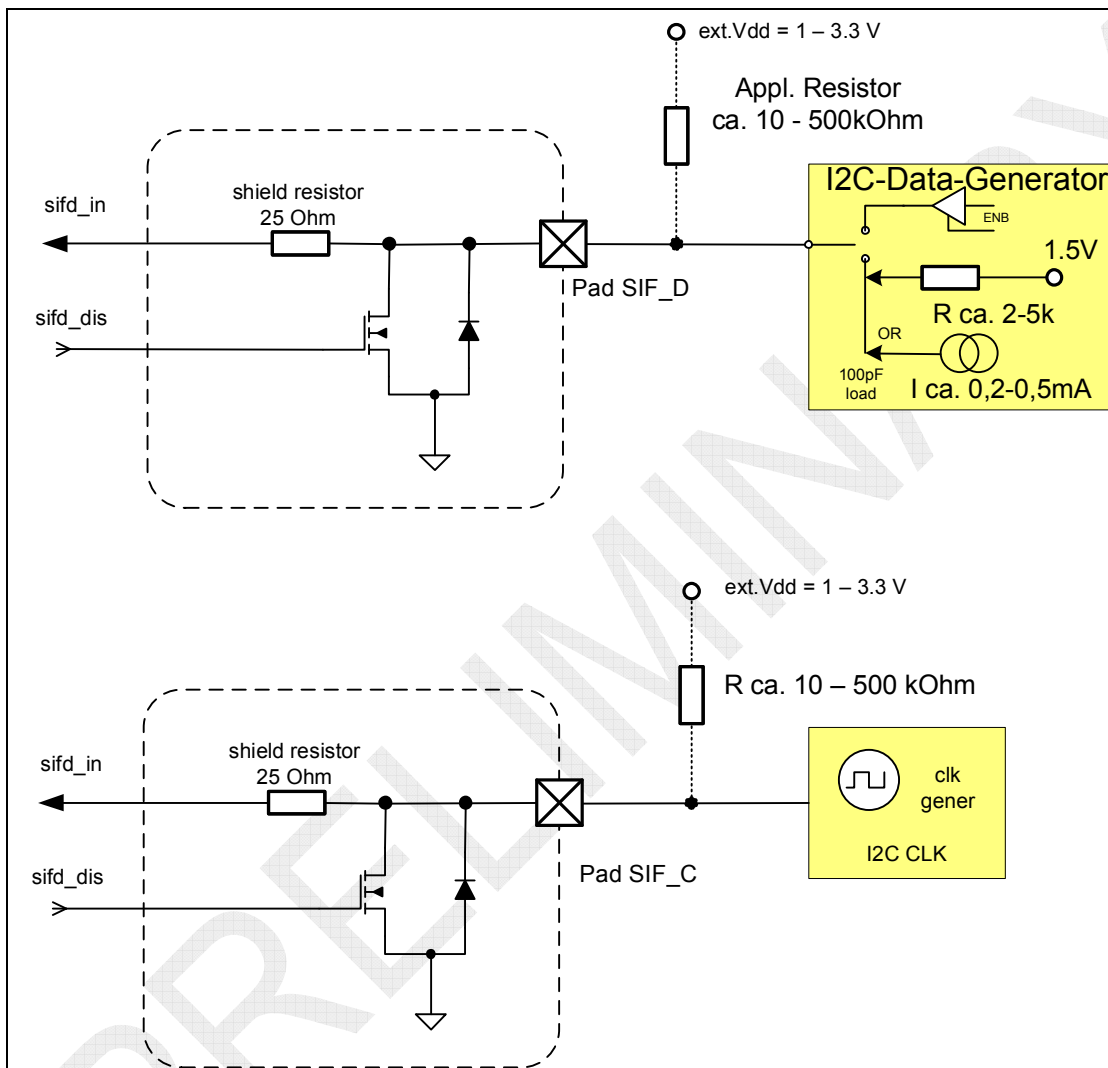

3.4.1. I²C Commands

There are two independent I²C-slaves integrated in the ZMD41211. Each command has to be sent within an I²C-frame. Latter contains the coded command of the respectively intended IC action. According to the individual command, data might have to be sent or received.

The following I²C communication sequence is valid for both, reading and writing of calibration data.

ZMD41211

Figure 3.3 I²C Communication Sequence

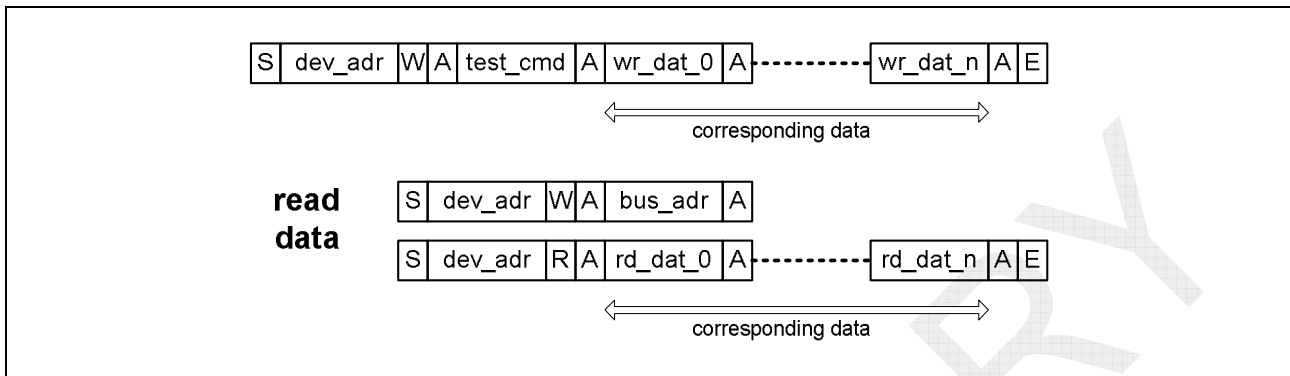

- **S:** I²C start of frame
- **W:** write bit = 0
- **A:** I²C acknowledge
- **test_cmd:** test command
- **rd_dat:** read data (command dependent)
- **bus_adr:** bus address
- **E:** I²C end of frame
- **R:** read bit = 1
- **Dev_adr:** I²C device address
- **wr_dat:** write data (command dependent)
- **dev_adr:** ZMD41211 device address

Device addresses for the ZMD41211 are fixed to 0x71 and 0x72 (assigned to battery management and to controller).

The command: test_cmd is the bus address for writing operations, whereas a dedicated bus address (bus_adr) must be transmitted by a separate command prior any read operation. With the transfer of data, the ZMD41211's internal address is incremented after each transmitted byte. At read operations, the acknowledge is generated by the I²C-master. The acknowledge bit has to be 1 and high, respectively, after the transmission of the last byte of read data.

The following test names describe an I²C-frame:

- W_name: write commands
- R_name: read commands
- P: pause
- O_name: observe commands on CUSTOM-out

Any I²C command is given in hexa-decimal code. An acknowledge from the ZMD41211 is denoted as „a“ and „ā“ denotes an acknowledge from the I²C master.

In the following subsections, the main commands are described i.e.:

- Access to User/Temperature Data EEPROM,
- Access to Battery Measurement Unit and
- Timer Oscillator.

Accessing the Parameter EEPROM and the Temperature Measurement Unit are required for calibration.

ZMD41211

Attention! With access to the Parameter EEPROM also the access to the password blocks is possible. Close the I²C access and connect SIFC and SIFD to V_{SS} in case the custom commands for password protection ought to be used.

3.4.1.1. Initialization Sequence

The IC must be initialized at the beginning of the command processing. The initialization starts timer and controller. The respective commands are summarized within the initialization sequence: **POWER_ON**.

Table 3.2 Command Sequence for IC Initialization

Command Name	I ² C Command	Comments
POWER_ON		Power initialization
W_Power_ON	sof-0xE2-a-0x4A-a-eof	Timer and controller on
P	Wait > 5ms	Pause
W_Contr_sleep	sof-0xE4-a-0x90-a-0x00-a-0x63-a-eof	Controller sleep
R_Power_Standard	Accept: sof-0xE3-a-0x07-ā-eof	Power on reset cycle successful

3.4.1.2. „Battery Measurement Unit“ Activation Sequence

There is a dedicated sequence to activate the Battery Measurement Unit (BMU). The general steps are: reset – start – monitor readiness – result request via data bus.

Table 3.3 Command Sequence for Temperature Measurement Unit (BMU) Activation

Command Name	I ² C Command	Comments
POWER_ON		Power initialization
W_CUS_Ready_BMU	sof-0xE4-a-0xCC-a-eof	Ready signal of BMU connection via custom-pad
W_Reset_BMU	sof-0xE4-a-0x27-a-0x02-a-eof	BMU reset
P	wait >1ms	
W_Reset_return	sof-0xE4-a-0x27-a-0x00-a-eof	Return reset
W_Start_BMU	sof-0xE4-a-0x27-a-0x04-a-eof	BMU Starts
O_rdy	Accept: rdy = 1	Observe ready signal = high
R_BMU_data	sof-0xE4-a-0x26-a-(eof) sof-0xE5-a-V1V2-ā-eof	Set bus address 26 _H , readout and saving of 7-bit counter data
Evaluation	V1V2 = 25 ... 60 decimal	V1V2=7-bit Voltage counter data
W_CUS_off	sof-0xE4-a-0xC0-a-eof	Custom pad connection: off
W_Power_OFF	sof-0xE2-a-0x45-a-eof	Power off

3.4.1.3. Writing User/Temperature Data EEPROM Sequence

The following command sequence enables a complete access to the User/Temperature Data EEPROM.

ZMD41211

Table 3.4 Command Sequence for Writing User/Temperature Data EEPROM

Command Name	I ² C Command	Comments
POWER_ON		Power initialization
W_timerosc_off	sof-0xE4-a-0x6F-a-0x00-a-eof	Switch-off clock
P	Wait > 3 ms	Pause
<i>Write into EEPROM[1] Valid address range 0x10 ...0x7F</i>		
W_GET_WIRE_RDY1	sof-0xE4-a-0xC8-a-eof	EEPROM[1]-Ready at custom pad
W_Eep1_data	sof-0xE4-a-0x28-a-byte0-a-byte1-a-byte2-a-byte3-a-adr-a-0x03-a-0x00-a-eof	Write data: byte 0-3 to address adr into EEPROM[1]
P	18ms	Monitor rdy at custom pad (output rdy1 = LH)
W_Eep1_dis	sof-0xE4-a-0x2D-a-0x00-a-0x00-a-eof	Ce0=we=0, EEPROM[1] disable
<i>write new data to other address</i>		
W_Eep1_data	sof-0xE4-a-0x28-a-byte0-a-byte1-a-byte2-a-byte3-a-other_adr-a-0x02-a-0x01-a-eof	Write data: byte 0-3 to address other_adr into EEPROM[1]
P	18ms	Monitor rdy at custom pad (output rdy1 = LH)
W_Eep1_dis	sof-0xE4-a-0x2D-a-0x00-a-0x00-a-eof	Ce0=we=0, EEPROM[1] disable
Disable_rdy	sof-0xE4-a-0xC0-a-eof	Deactivate monitoring after end of writing
<i>Write into EEPROM[2] Valid address range 0x80 ...0xFF</i>		
W_GET_WIRE_RDY2	sof-0xE4-a-0xC9-a-eof	EEPROM[2]-Ready at custom pad
W_Eep2_data	sof-0xE4-a-0x28-a-byte0-a-byte1-a-byte2-a-byte3-a-adr-a-0x03-a-0x00-a-eof	Write data: byte 0-3 to address adr into EEPROM[2]
P	18ms	Monitor rdy at custom pad (output rdy2 = LH)
W_Eep2_dis	sof-0xE4-a-0x2D-a-0x00-a-0x00-a-eof	Ce0=we=0, EEPROM[2] disable
Disable_rdy	sof-0xE4-a-0xC0-a-eof	Deactivate monitoring after end of writing

ZMD41211

3.4.1.4. Readout User/Temperature Data EEPROM Sequence

Table 3.5 Command Sequence for User/Temperature Data EEPROM Readout

Command Name	I ² C Command	Comments
<i>Read from EEPROM[1/2] Valid address range 0x10 ...0xFF</i>		
W_Eep1_ADR	sof-0xE4-a-0x2C-a-adr-a-0x00-a-0x05-a-eof	Create EEPROM-address, ce=oe=1, start readout
W_Eep1_Dis	sof-0xE4-a-0x2D-a-0x00-a-0x00-a-eof	data takeover to bus
R_Data_out	sof-0xE4-a-0x28-a-(eof) sof-0xE5-a-byte0-a-byte1-a-byte2-a-byte3-ā-eof	Set bus address, read block content: byte-0-1-2-3
W_Power_OFF	sof-0xE2-a-0x45-a-eof	Power off

3.4.1.5. Timer Oscillator Activation Sequence

In the power on sequence oscillator gets the trim values, TTEMP and TTEMP from EEPROM Block03. The trim values can be determined during the IC's wafer test.

Table 3.6 Command Sequence for Timer Oscillator Activation Sequence

Command Name	I ² C Command	Comments
POWER_ON		Power initialization
W_CUS_8kclk	sof-0xE4-a-0xCA-a-eof	8kHz clock connection via custom-pad
P	wait >1ms	
O_8kclk_frequency	Accept: 8kclk = 8192Hz ± 3%	measure timer frequency
W_CUS_off	sof-0xE4-a-0xC0-a-eof	Custom pad connection: off
W_Power_OFF	sof-0xE2-a-0x45-a-eof	Power off

ZMD41211

4 Transponder Commands

4.1. Format of Custom Command

The generally valid format of the custom commands is as follows:

SOF	Flag	Custom Command Code B0...BE	Mfc code, fixed=17h	Custom request parameters	CRC16	EOF
	8 bit	8 bit	8 Bit	Custom defined		

4.2. Command List

A complete description of the ZMD41211's commands is given in the ZMD41211 Command Description.

4.2.1. ISO15693 Compatible Commands

The ISO commands being implemented are listed in table 4.1. Structure and meaning of the commands are according to the ISO standard: ISO_15693-3.

Table 4.1 ISO Commands

Cmd Code	Command	Description
Mandatory		
01	Inventory	ZMD41211 shall perform the anti-collision sequence
02	Stay Quiet	ZMD41211 enters the quiet state
Optional		
20	Read Single Block	Read the requested block
21	Write Single Block	Write the requested block
23	Read Multiple Blocks	Read the requested multi-block
25	Select	set to "Selected" state
26	Reset to ready	Return the ZMD41211 to the "Ready" state
27	Write AFI	Write the AFI value to ZMD41211
29	Write DSFID	Write the DSFID value to ZMD41211
2B	Get System Info	Fetch the system information value from ZMD41211

ISO commands can only access the blocks which are allowed for measurement and customer data i.e., blocks 10_H to FF_H.

ZMD41211

4.2.2. Custom Commands

Any customized write command includes an option flag according to the ISO command structure of “Write Single Block”. Thus one can influence the waiting behaviour of different reader types which support commands with response times >20ms.

Table 4.2 Custom Commands

Cmd Code	Command	Option Flag ¹	Description
Custom			
B0	Init	yes	Delete whole memory of the ZMD41211
B1	Set_Log_Mode	yes	Set Log Parameter
B2	Set_Log_Timer	yes	Set Log interval and preset time
B3	Set_Custom	yes	Set custom output setting
B4	Start_Log	yes	Start log procedure
B5	Get_Log_State	no	Get log state of the ZMD41211
B6	Set_Passive	no	Stop log procedure
B7	Get_Timer_State	no	Get currently time state
B8	Get_State	no	Get state of ZMD41211
B9	Get_One_Block	no	Read requested system block
BA	Timer_Sync	yes	Synchronize oscillator with reader frequency
BB	Get_Voltage	yes	Measure battery voltage
BC	Set_Cal	yes	Set calibration values
BD	Verify_Pwd	no	Verify password
BE	Set_Pwd	yes	Set password

¹ - Option Flag refer to ZMD41211 Command Description

4.3. Data Security

A three-level password concept controls:

- access to EEPROM data and
- rights to carry out transponder commands.

The parameter EEPROM provides space for three different passwords.

The Command Decoder will enter the “Password-Verified” state, if a special check routine is started after the transponder has entered the RFID-field. Dependent on the content of the password blocks: 0x0D to 0x0F, only limited access to the EEPROM is granted and a limited number of transponder commands can be realized, respectively.

Remark: An access lock-out is safe only if the outer access to SIFD and SIFC is prevented by e.g., shielding with a cover foil.

Table 4.3 provides an overview of the access rights according to the respective password assignments.

ZMD41211

Table 4.3 Access Rights According to Password Usage

Code	Command	PWD_verified	Code	Command	PWD_verified
Mandatory			Custom		
01	Inventory	–	B0	Init	2
02	Stay Quiet	–	B1	Set_Log_Mode	1
			B2	Set_Log_Timer	1
Optional			B3	Set_Custom	1
20	Read Single Block	1	B4	Start_Log	1
21	Write Single Block	see below	B5	Get_Log_Status	1
23	Read Multiple Blocks	1	B6	Set_Passiv	1
25	Select	–	B7	Timer_Status	1
26	Reset to ready	–	B8	Get_Status	1
27	Write AFI	2	B9	Get_One_Block	1
29	Write DSFID	2	BA	Timer_Sync	2
2B	Get System Info	–	BB	U_Batt	1
Details for „Write Single Block“:			BC	Kal_T	2
21	Write Block in Addresses:		BD	Verify_Pwd	–
	10 _H to VCB + 10 _H	1	BE	Write_Pwd1	1
	VCB + 10 _H to FF _H	3	BE	Write_Pwd2	2
			BE	Write_Pwd3	3

The three levels depend on each other as follows:

- *PWD3 verified* complies with 3 = maximum security (includes 2 and 1),
- *PWD2 verified* complies with 2 = medium security (includes 1),
- *PWD1 verified* complies with 1 = lowest security,
- *No PWD verified* complies with – = no security.

Further details on the security properties and options of the ZMD41211 can be found in the “ZMD41211 Command Description”

ZMD41211

5 Calibration Procedure

Temperature and battery voltage will be stored in EEPROM after the measurement's completion. Two pairs of values (CCNTx, CTEMPx) are stored for the interpretation of the counter content in the parameter section of the EEPROM. At any preset temperature, the counter content is output by the "Temperature Measurement Unit". A pair of values for calibration, i.e. a calibration point consists of such a counter content and the respective temperature.

A linear approximation of the relation between temperature and counter content can be achieved as soon as two different calibration points have been obtained. Thereby the measurement precision of the temperature is determined by the control precision of the reference calibration temperature.

The generation of calibration data, the storage in EEPROM and the processing of the counter content into temperature values are content of this chapter.

5.1. Calibration Block Segmentation

Temperature and counter content are stored as 10bit-values with an additional (11th) sign bit for the temperature. The pairs of values are stored in the calibration blocks with the addresses 05_H – 07_H within the parameter EEPROM.

Table 5.1 Structure of Block 05 for Calibration Data

Bit [31:22]	Bit [31:11]	Bit [10:0]
Counter content: lower calibration temperature	Upper calibration temperature	Lower calibration temperature
CCNT1	CTEMP2	CTEMP1

30	28	26	24	22	20	18	16	14	12	10	8	6	4	2	0	
CCNT1					sig	CTEMP2					sig	CTEMP1				

Table 5.2 Structure of Block 06 for Calibration Data

Bit [29:20]	Bit [19:14]	Bit [13:08]	Bit [5:0]
Counter content: upper calibration temperature	High calibration voltage, battery	Battery threshold	Low calibration voltage, battery
CCNT2	CBH	CBTH	CBL

30	28	26	24	22	20	18	16	14	12	10	8	6	4	2	0
0	CCNT2					CBH			CBTH			0	CBL		

ZMD41211

Table 5.3 Structure of Block 07 for Calibration Data

Bit [31:24]	Bit [23:21]	Bit [20:11]	Bit [10:0]
CRC8	Reserve = 0x00	CCNT3	CTEMP3

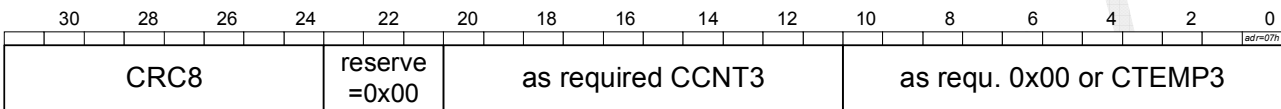

Recommendation for representation of the absolute temperature (CTEMPx)

Name	Bit(s)	Description
ABSVAL	9:0	Absolute Temperature Value Ten times the absolute value of the temperature with 0°C being 000 _H 1LSB correspond to 0.2K; the binary transfer is Temp[°C] · 10 = CTEMPx
SIGN	10	Sign of the Temperature Required since temperature value is interpreted as centigrade

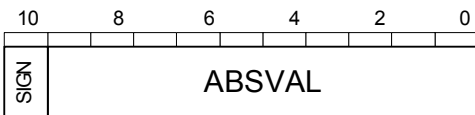

Annotation: The measurement range is -102.3°C (i.e. 7FF_H) to +102.3°C (i.e. 3FF_H).

ZMD41211

5.2. Calibration Principle

The mathematical principle of the calibration is object of this section.

5.2.1. Two-Point Calibration

The two-point calibration is the favored principle for the ZMD41211. In general, a linear approximation of the respective measurement and reference values is achieved by the two-point calibration.

5.2.1.1. Temperature Measurement

For the temperature, the two-point calibration yields a linearization precision of $\pm 1K$. The following picture illustrates the general placement of the calibration points. Latter have to be selected within the valid temperature range of $-30^{\circ}C$ to $+50^{\circ}C$. The condition $CTEMP1 < CTEMP2$ must be fulfilled.

Figure 5.1 Temperature Calibration Point Location

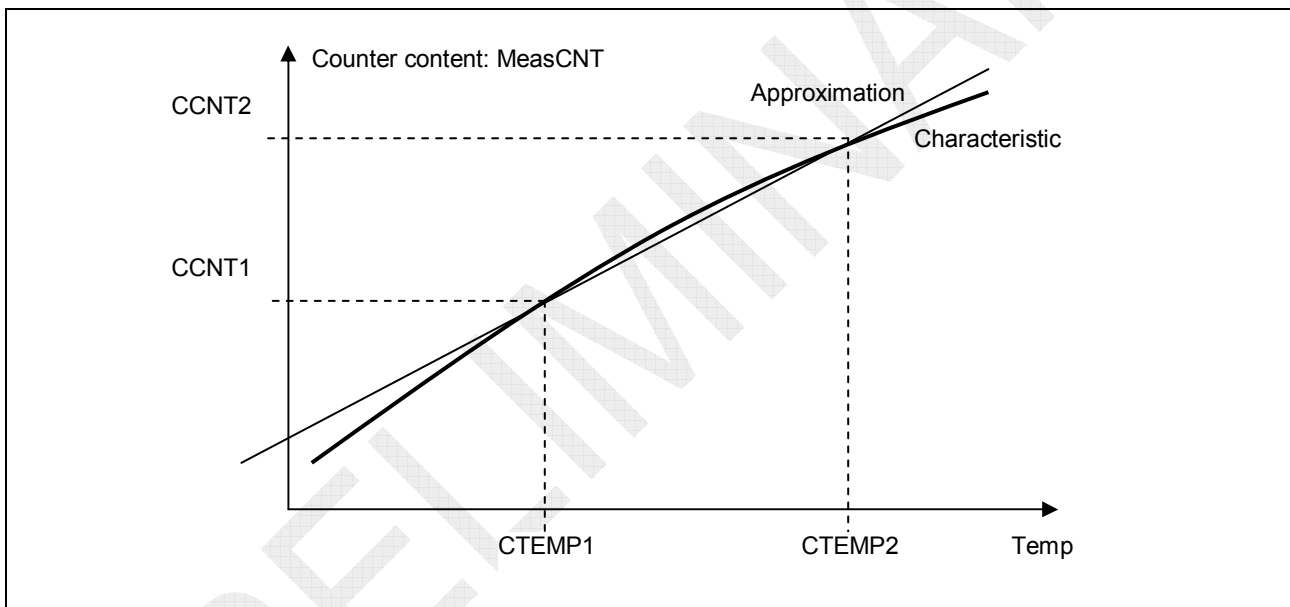

The linear approximation is realized via the following calculations. The linear curve is represented by:

$$Temp = K1 \cdot MeasCNT + K2$$

With

$$\begin{pmatrix} K1 \\ K2 \end{pmatrix} = \begin{pmatrix} CCNT1 & 1 \\ CCNT2 & 1 \end{pmatrix}^{-1} \cdot \begin{pmatrix} CTEMP1 \\ CTEMP2 \end{pmatrix}$$

we obtain

$$K1 = \frac{CTEMP2 - CTEMP1}{CCNT2 - CCNT1} \quad \text{and} \quad K2 = \frac{CTEMP1 \cdot CCNT2 - CTEMP2 \cdot CCNT1}{CCNT2 - CCNT1}$$

ZMD41211

The measurement temperature is defined as:

$$MeasTemp = K1 \cdot MeasCNT + K2 .$$

The *desired_temperature_limit* leads the lower/upper temperature limit of the internal counter being determined by:

$$CNTmin \text{ or } CNTmax = (desired_temperature_limit - K2) / K1 .$$

PRELIMINARY

ZMD41211

5.2.1.2. Voltage Measurement

Usually, during the chip selection on the wafer, fixed voltage levels are defined for the later calibration. The counter contents CBH and CBL are determined for battery voltages of 1.5V and 1.1V, respectively and written to block 06 of the calibration data.

Figure 5.2 Battery Voltage Calibration Point Location

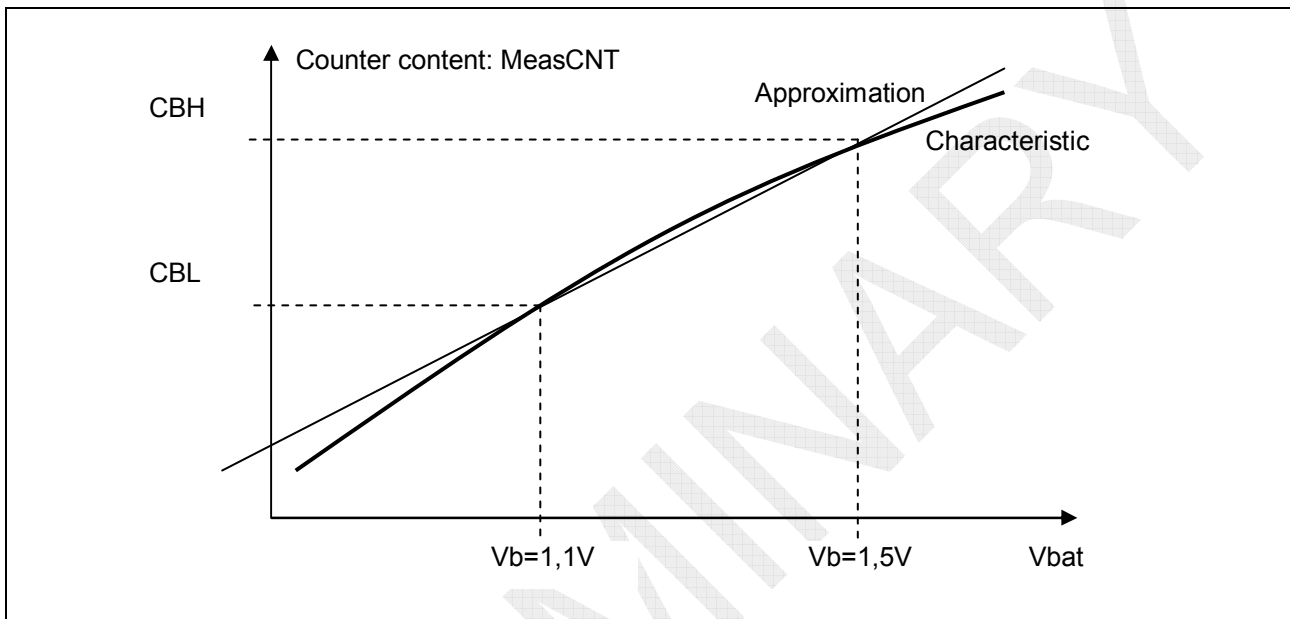

The linear approximation is realized via the following calculations. The linear curve is represented by:

$$V_{bat} = K1 * MeasCNT + K2$$

With

$$\begin{pmatrix} K1 \\ K2 \end{pmatrix} = \begin{pmatrix} CBL & 1 \\ CBH & 1 \end{pmatrix}^{-1} \cdot \begin{pmatrix} 1,1V \\ 1,5V \end{pmatrix}$$

we obtain

$$K1 = \frac{1,5V - 1,1V}{CBH - CBL} \quad \text{and} \quad K2 = \frac{1,1V \cdot CBH - 1,5V \cdot CBL}{CBH - CBL}$$

Hence, the battery voltage can be determined as:

$$MeasV_{bat} = K1 \cdot MeasCNT + K2 .$$

ZMD41211

5.2.2. Three-Point Calibration

The three-point calibration is more expensive regarding measurements and calculations. Nevertheless the cubic approximation can improve the measurement precision to $\pm 0.5K$ within the range of $-30^{\circ}C$ to $+50^{\circ}C$.

Figure 5.3 Illustration of 3-Point Calibration

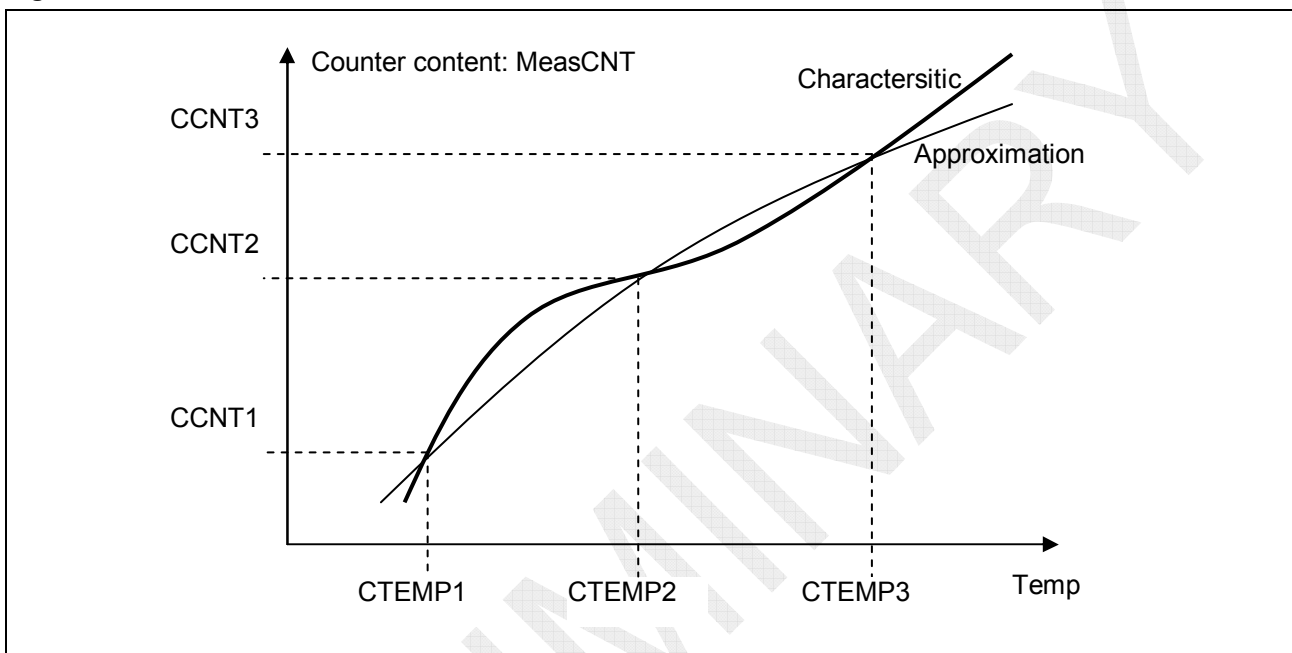

The approximation function is

$$Temp = K1 \cdot (MessCNT)^2 + K2 \cdot MessCNT + K3 \quad , \text{ whereas}$$

$$\begin{pmatrix} K1 \\ K2 \\ K3 \end{pmatrix} = \begin{pmatrix} CTEMP1^2 & CTEMP1 & 1 \\ CTEMP2^2 & CTEMP2 & 1 \\ CTEMP3^2 & CTEMP3 & 1 \end{pmatrix}^{-1} \cdot \begin{pmatrix} CCNT1 \\ CCNT2 \\ CCNT3 \end{pmatrix}$$

leads to the respective constants $K1$, $K2$ and $K3$, which are determined by matrix operations. If a three-point calibration shall be performed, the third calibration point will have to be stored in the block 07.

ZMD41211

5.3. Cyclic Redundancy Check (CRC) Calculation for Validation of Calibration Data

A CRC8 value of the calibration data block is generated and stored in the EEPROM. The purpose is to ensure the data retention and thus consistence of the calibration data by later checks.

Table 5.4 *Byte fragmentation of Calibration Blocks*

Block	Byte 0 (D0)	Byte 1 (D1)	Byte 2 (D2)	Byte 3 (D3)
05 _H	CTEMP1	CTEMP1/2	CTEMP2	CCNT1
06 _H	CCNT2	CCNT2/CBH	CBTH	CBL
07 _H	0x00	0x00	0x00	CRC

The EEPROM data should be transferred to the CRC calculating function as a byte-array of the form:

B05(D0), B05(D1), B05(D2), B05(D3), B06(D0), B06(D1), B06(D2), B06(D3), B07(D0), B07(D1), B07(D2).

The obtained 8-bit wide CRC8 value is written to B07(D3).

The analyzing software reads out the respective blocks. The bytes are processed according to the scheme presented above and compared to the CRC8 checksum. If a match of both checksums is detected, the data will be valid.

C-Function for Determination of CRC8:

```

unsigned char Calculate_CRC8(unsigned char* Datapointer, unsigned char Quantity)
{
    unsigned char i, k, CRC_Rest;
    CRC_Rest = 0; // reset Rest
    for (i = 0; i < Quantity; i++) // Loop for all Bytes
    {
        CRC_Rest ^= Datapointer[i]; // new Byte XOR
        for (k = 0; k < 8; k++) // Loop for all Bits
        {
            if (CRC_Rest & 0x80) // if MSB equals 1
            {
                CRC_Rest <<= 1; // Rest: 1. digit to the left
                CRC_Rest ^= 0x07; // x8+x2+x+1 => 0x07
            }
            else CRC_Rest <<= 1; // Rest: 1. digit to the left
        }
    }
    return CRC_Rest;
}

```

A CRC-function call would be e.g.: `Testvariable = Calculate_CRC8(DATA, 11);`

ZMD41211

5.4. Calibration Flow

This section provides the detailed information about the possible calibration flows at the ZMD41211.

5.4.1. Calibration via Wireless Communication

The calibration via the RF-transponder interface is especially advisable for re-calibration of the finished label. The application must be ZMD41211 in combination with coil and battery (1.5V). The IC's command pool includes a custom command (SET CAL) for overwriting the blocks which contain calibration data. (cp. Command description)

Structure of SET CAL:

KAL_T1:	KAL_T data = block 05 _H
KAL_T2:	KAL_T data = block 06 _H
KAL_T3:	KAL_T data = block 07 _H

Table 5.5 Command Format of SET CAL

Request Format								
SOF	Flags	SET CAL	IC Mfg code (0x17)	UID optional	KAL_T#	KAL_T	CRC16	EOF
	8 bits	BC _H	8 bits	64 bits	8 bits	32 bits	16 bits	

Valid values for KAL_T# are 1, 2 and 3.

Response format

Table 5.6 Command Response when Error Flag is set

SOF	Flags	Error Code	CRC16	EOF
	8 bits	8bits	16 bits	

Table 5.7 Command Response when Error Flag is not set

SOF	Flags	CRC16	EOF
	8 bits	16bits	

ZMD41211

Determination of CTEMP

To determine CTEMP is very time-consuming. Via the RF-interface, it is only possible to retrieve the counter content with the ZMD41211 being in logging mode (Data Logger Application). The logging mode 1 has to be set, i.e. save any value, and the counter content over time is written into the EEPROM.

After the settling time of the temperature, the counter content has to be fetched by the ISO-command: READ MULTIPLE BLOCKS. If the variation of the counter content is less or equal 2 counts, then the pair of values: CCNT and CTEMP can be stored with SET CAL into the respective EEPROM block.

Figure 5.4 Typical Settling Behaviour

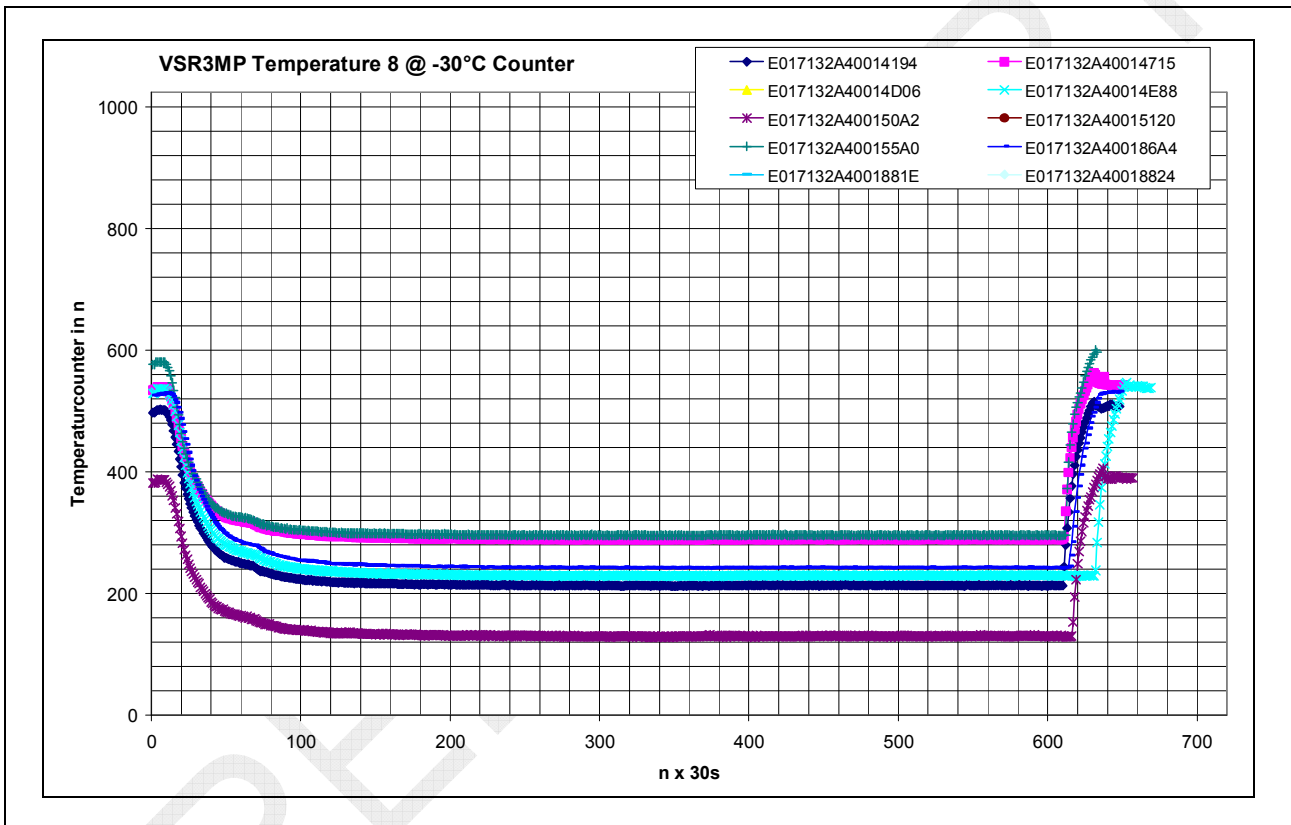

PRELIMINARY

ZMD41211

5.4.2. Calibration via I²C-Interface

For the I²C calibration, the ZMD41211 needs a 1.5V supply and the pads SIFC, CIFD and CUSTOM must be connected. The connection of a coil is not stringently required to realize the calibration via I²C.

Communication Sequence is described in section 3.4.

5.4.2.1. „Temperature Measurement Unit“ Activation Sequence

There is a dedicated sequence to activate the Temperature Measurement Unit (TMU). The general steps are: reset – start – monitor readiness – result request via data bus.

Table 5.8 Command Sequence for Temperature Measurement Unit (TMU) Activation

Command Name	I ² C Command	Comments
POWER_ON		Power initialization
W_CUS_Ready_TMU	sof-0xE4-a-0xCB-a-eof	Ready signal of TMU connection via custom-pad
W_Reset_TMU	sof-0xE4-a-0x27-a-0x02-a-eof	TMU reset
W_Reset_return	sof-0xE4-a-0x27-a-0x00-a-eof	Return reset
W_Start_TMU	sof-0xE4-a-0x27-a-0x01-a-eof	TMU Starts
O_rdy	Accept: rdy = 1	Observe ready signal = high
R_TMU_data	sof-0xE4-a-0x24-a-(eof) sof-0xE5-a-T2T1 -a-T4T3-ā-eof	Set bus address 24 _H , readout and saving of 10-bit counter data
Evaluation	T4T3T2T1 = 700 ... 240 decimal	T4T3T2T1=10-bit temperature counter data
W_CUS_off	sof-0xE4-a-0xC0-a-eof	Custom pad connection: off
W_Power_OFF	sof-0xE2-a-0x45-a-eof	Power off

ZMD41211

5.4.2.2. Writing Parameter-EEPROM Sequence

The Parameter-EEPROM must be filled with appropriate measurement and reference data for calibration. Therefore the following sequence must be used. (Valid address range 0x00 ...0x0F)

Table 5.9 Command Sequence for Writing Parameter-EEPROM

Command Name	I ² C Command	Comments
POWER_ON		Power initialization
W_timerosc_off	sof-0xE4-a-0x6F-a-0x00-a-eof	Switch-off clock
P	Wait > 3 ms	Pause
W_GET_WIRE_RDY0	sof-0xE4-a-0xC7-a-eof	EEPROM[0]-Ready at custom pad
W_Eep0_data	sof-0xE4-a-0x28-a-byte0-a-byte1-a-byte2-a-byte3-a-adr-a-0x02-a-0x01-a-eof	Write data: byte 0-3 to address adr into EEPROM[0]
P	18ms	Monitor rdy at custom pad (output rdy = LH)
W_Eep0_dis	sof-0xE4-a-0x2D-a-0x00-a-0x00-a-eof	Ce0=we=0, EEPROM[0] disable
<i>write new data to other address</i>		
W_Eep0_data	sof-0xE4-a-0x28-a-byte0-a-byte1-a-byte2-a-byte3-a-other_adr-a-0x02-a-0x01-a-eof	Write data: byte 0-3 to address other_adr into EEPROM[0]
W_Eep0_dis	sof-0xE4-a-0x2D-a-0x00-a-0x00-a-eof	Ce0=we=0, EEPROM[0] disable
Disable_rdy	sof-0xE4-a-0xC0-a-eof	Deactivate monitoring after end of writing

5.4.2.3. Readout Parameter-EEPROM Sequence

Table 5.10 Command Sequence for Parameter-EEPROM Readout

Command Name	I ² C Command	Comments
<i>Read from EEPROM[0] Valid address range 0x00 ...0x0F</i>		
W_eep0_ADR	sof-0xE4-a-0x2C-a-adr-a-0x00-a-0x01-a-eof	Create EEPROM-address, ce=oe=1, start readout at adr
W_Eep0_Dis	sof-0xE4-a-0x2D-a-0x04-a-0x01-a-eof	set ce and oe
W_Eep0_Dis	sof-0xE4-a-0x2D-a-0x00-a-0x00-a-eof	data takeover to bus
R_Data_out	sof-0xE4-a-0x28-a-(eof) sof-0xE5-a-byte0-a-byte1-a-byte2-a-byte3-ā-eof	Set bus address, read block content: byte-0-1-2-3
W_Power_OFF	sof-0xE2-a-0x45-a-eof	Power off

ZMD41211

6 Memory Map

The memory is organized in 256 Blocks of 32 bit each.

Figure 6.1 *EEPROM Overview – Quasi-Permanent Data*

Block (hex)	Content Parameter EEPROM			
	Byte0	Byte1	Byte2	Byte3
00	ISO 15693 UID			
01				
02	ISO data storage identifier			
	DSFID	AFI	Memory size field	
03	Timer trim Parameter / Chip Revision			
04	Parameter Temp-Time-Product / Custom Blocks			
05	Calibration Parameter for Temperature and Voltage			
06				
07				
08	Timer start time			
09	Timer preset time / Log interval			
0A	Log modes			
0B	Log status bits			
0C	Reserve			
0D	Password 1			
0E	Password 2			
0F	Password 3			

Figure 6.2 *EEPROM Overview – Measurement Data*

Block (hex)	Content User / Temp-Data EEPROM			
	Byte0	Byte1	Byte2	Byte3
10	User Data region			
11				
...				
10+CB	Measurement data			
11+CB	Measurement data			
...				
...				
FF	Measurement data			

CB = Number of Custom Blocks

ZMD41211

7 Pin Configuration and Package

7.1. Pin Configuration

The package of the ZMD41211 is an SSOP14 green package (5.3mm body width) with a lead pitch of 0.65 mm.

Figure 7.1 Pin-out Diagram

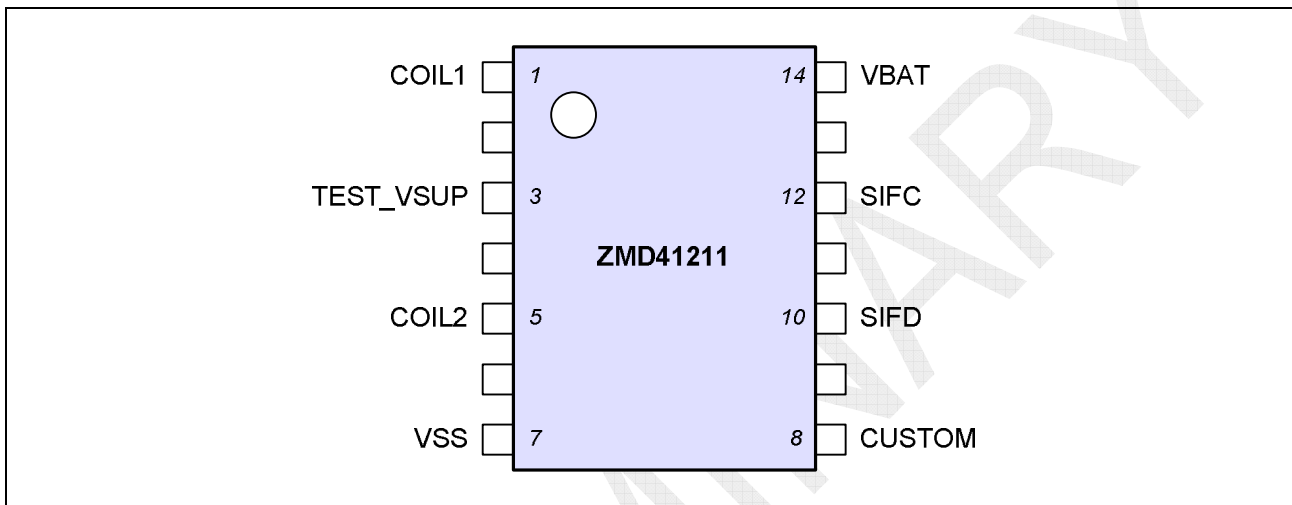

ZMD41211

7.2. Pin/Pad description

Table 7.1 Pin List

Pin	Name	Type	Description
1	COIL1	HVA	coil pad 1: connects to one terminal of the external coil
2	n.c.		not connected
3	TEST_VSUP	HVA	Test pad for Vsup
4	n.c.		not connected
5	COIL2	HVA	coil pad 2: connects to the other terminal of the external coil
6	n.c.		not connected
7	VSS		Negative / reference supply voltage / power connect
8	CUSTOM	D_O	SCLK: serial clock
9	n.c.		not connected
10	SIFD	Open drain IO	Sensor-Interface: I ² C Data
11	n.c.		not connected
12	SIFC	Open drain IO	Sensor-Interface: I ² C Clock
13	n.c.		not connected
14	VBAT	VDD	Positive supply voltage / power, connect for Data Logging
	Vpp1	no ESD diode, only for test	Test pad for internal User-EEPROM Charge Pump (progr. voltage 12V)
	Vpp2		Test pad for internal Parameter-EEPROM Charge Pump (progr. volt. 12V)

Explanation of Pin type:

- HVA: high voltage analog Pad with ESD diode to VSS
- VDD: Power supply Pad with ESD diode to VSS
- D_O: tristate digital output with ESD diode to VSS and VBAT
- Open drain IO: open drain bidirectional Pad with ESD diode to VSS

ZMD41211

7.3. CHIP Layout

Figure 7.2 Chip Layout

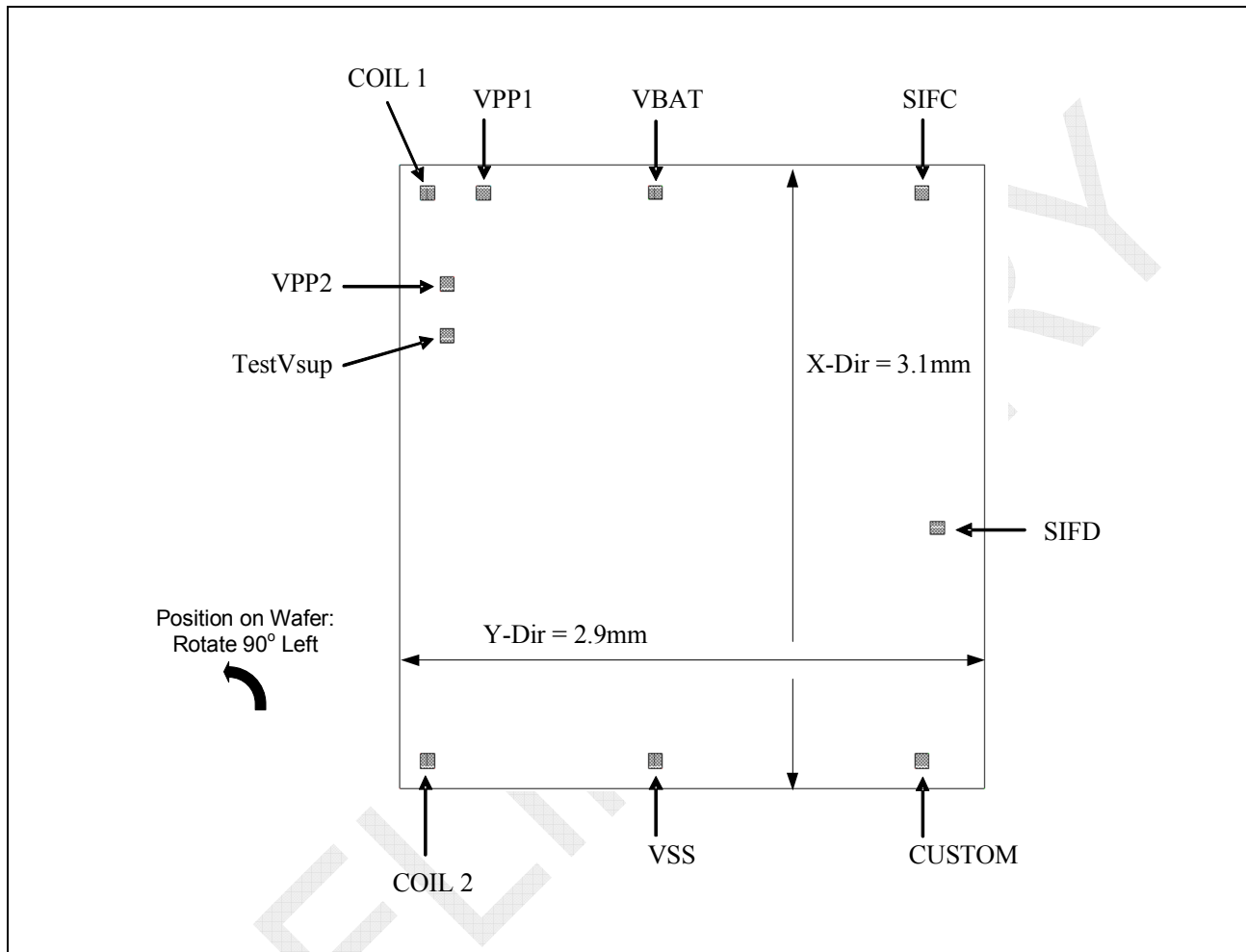

Chip Grid (incl. Scribeline): x=3.23mm Y = 3,03mm
 Scribeline with: 80um
 Pad size: (74 x 74) um

ZMD41211

8 Application Notes

8.1. Connection of External Sensor

Figure 8.1 shows examples for the connection of sensors (with supply in the range: 2.7V to 3.3V) to the ZMD41211. If no external sensor was connected to the ZMD41211, it is recommended to connect SIFC and SIFD to V_{SS} . In the figure on the right hand side, the lamp is a substitute for any signalling annunciator. However, the continuous load current has to be less than 1 mA.

Figure 8.1 Schematic with Sensor (left) and with Annunciator (right)

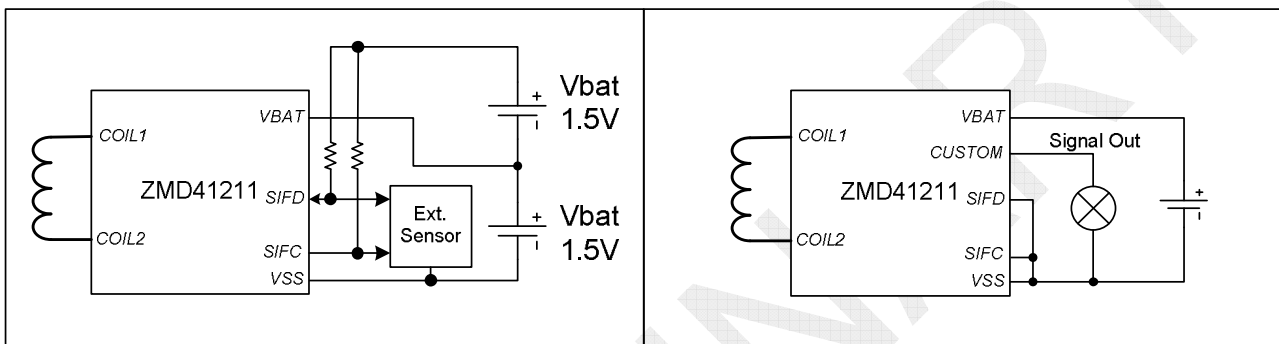

8.2. Antenna Layout

A potential layout of the antenna coil (connected to Coil1 and Coil2) is shown in Figure 8.2. Four or five turns are recommended depending on the distributed capacitance. For the shown antenna layout, if turn 5 is not required, it will remain open. The red line represents the connection crossover and can be placed on the backside of the label. The label dimensions would be 78mm by 48mm.

Figure 8.2 Antenna Layout Example

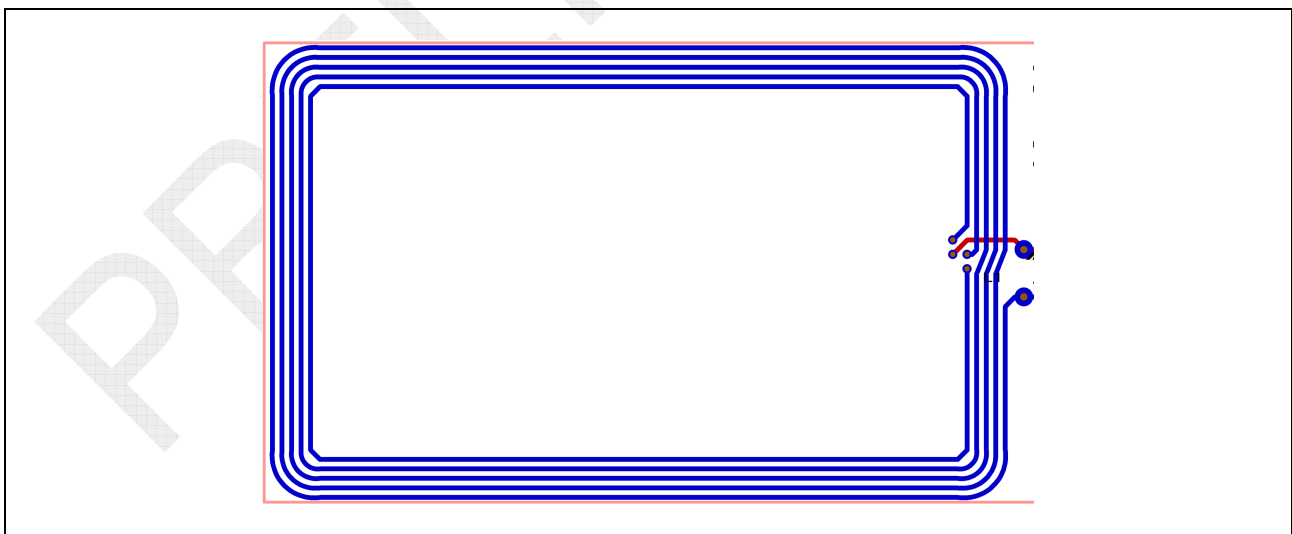

ZMD41211

9 Additional Documents

Document	File Name
ZMD41211 Command Description	ZMD41211_CommandDescription_Rev_1p0.PDF

Visit ZMD's website www.zmd.biz or contact your nearest sales office for the latest version of these documents.

PRELIMINARY

ZMD41211

10 Glossary

Term	Description
ASK	Amplitude Shift Keying
AFI	Application Family Identifier
CB	Custom Block
CCNT	Calibration Counter
CRC	Cyclic Redundancy Check
DSFID	Data Storage Format Identifier
EOF	End of Frame
FSK	Frequency Shift Keying
ISO	International Standard Organization
LSB	Least Significant Bit
MSB	Most Significant Bit
RF	Radio Frequency
SOF	Start of Frame
TTP	Temperature Time Product
UID	Unique Identifier

PRELIMINARY

ZMD41211

11 Document Revision History

Revision	Date	Description
0.5	August 12 th , 2008	Preliminary Outline
0.7	September 30 th , 2008	Incorporation of Commands and Detailed Descriptions

Sales Offices and further Information

www.zmd.biz

ZMD AG	ZMD America, Inc.	ZMD Far East
Grenzstrasse 28 01109 Dresden, Germany Phone +49 (0)351.8822.7.772 Fax +49 (0)351.8822.87.772 sales@zmd.de	201 Old Country Road, Suite 204 Melville, NY 11747, USA Phone +01 (631) 549-2666 Fax +01 (631) 549-2882 sales@zmda.com	1F, No.14, Lane 268 Sec. 1 Guangfu Road HsinChu City 300, Taiwan Phone +886.3.563.1388 Fax +886.3.563.6385 sales@zmd.de