

# 5.0V LOW POWER PRECISION REFERENCE SOURCE

# ZRT050

ISSUE 1 - OCTOBER 1995

## DEVICE DESCRIPTION

The ZRT050 is a monolithic integrated circuit providing a precise stable reference voltage of 4.9V at 500 $\mu$ A.

The circuit features a knee current of 150 $\mu$ A and operation over a wide range of temperatures and currents.

The ZRT050 is available in a 3-pin metal can package for through hole applications as well as SOT223 and SO8 packages for surface mount applications. Each package option offers a trim facility whereby the output voltage can be adjusted as shown in Fig.1. This facility is used when compensating for system errors or setting the reference output to a particular value. When the trim facility is not used, the pin should be left open circuit.

## FEATURES

- Trimmable output
- Excellent temperature stability
- Low output noise figure
- Available in two temperature ranges
- 1 and 2% initial voltage tolerance versions available
- No external stabilising capacitor required in most cases
- Low slope resistance
- TO18 package
- SOT223 and SO8 small outline packages

## SCHEMATIC DIAGRAM

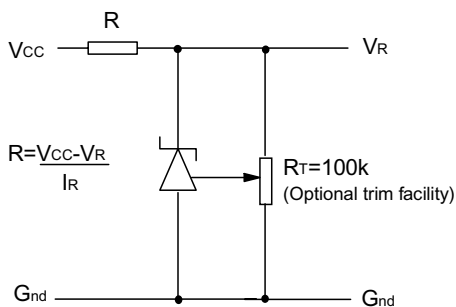

**Figure 1:**

This circuit will allow the reference to be trimmed over a wide range. The device is specified over a  $\pm 5\%$  trim range.

# ZRT050

## ABSOLUTE MAXIMUM RATING

Reverse Current	60mA $\emptyset$
Operating Temperature	A grade -55°C to 125°C C grade 0°C to 70°C
Storage Temperature	TO18 -55 °C to 175 °C SO8, SOT223 -55 °C to 125 °C

## Power Dissipation ( $T_{amb}=25^{\circ}\text{C}$ )

TO18	300mW
SO8	625mW
SOT223	2W
$\emptyset$ Above 25°C this figure should be linearly derated to 12mA at 125°C	

## TEMPERATURE DEPENDENT ELECTRICAL CHARACTERISTICS

SYMBOL	PARAMETER	INITIAL VOLTAGE TOLERANCE %	GRADE A -55°C TO 125°C		GRADE C 0°C TO 70°C		UNITS
			TYP	MAX	TYP	MAX	
$\Delta V_R$	Output voltage change over relevant temperature range (See note (a))	1 & 2	13.5	45.0	5.4	17.2	mV
$T_C V_R$	Output voltage temperature coefficient (See note (b))	1 & 2	15.0	50.0	15.0	50.0	ppm/°C

## ELECTRICAL CHARACTERISTICS

( at  $T_{amb}=25^{\circ}\text{C}$  and trim pin unless otherwise stated)

SYMBOL	PARAMETER	MIN.	TYP.	MAX.	UNITS	COMMENTS
$V_R$	Output voltage 1% tolerance (A1,C1) 2% tolerance (C2)	4.85 4.80	4.90 4.90	4.95 5.00	V	$I_R=500\mu\text{A}$
$\Delta V_{TRIM}$	Output voltage adjustment range		$\pm 5$		%	$R_T=100\text{k}\Omega$
$T_C \Delta V_{TRIM}$	Change in $T_C V_R$ with output adjustment		2.5		ppm/°C/%	
$I_R$	Operating current range	0.15		60	mA	See note (c)
$t_{on}$ $t_{off}$	Turn-on time Turn-off time		100 0.3		$\mu\text{s}$	$R_L=1\text{k}\Omega$
$e_{np-p}$	Output voltage noise (over the range 0.1 to 10Hz)		50		$\mu\text{V}$	Peak to peak measurement
$R_S$	Slope resistance		1.25	2.0	$\Omega$	$I_R = 0.5\text{mA}$ to 5mA See note (d)

## TYPICAL CHARACTERISTICS

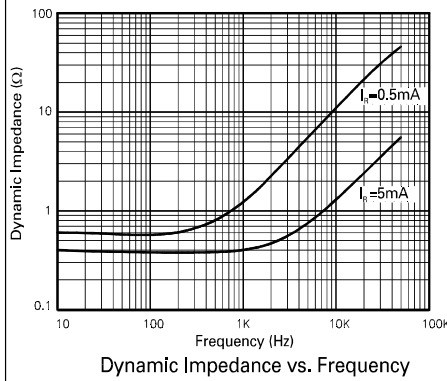
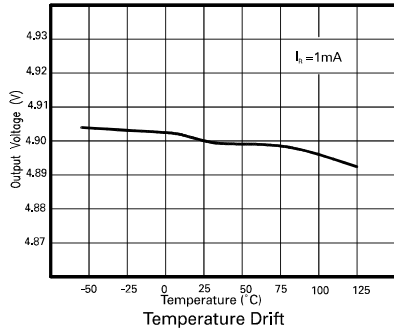
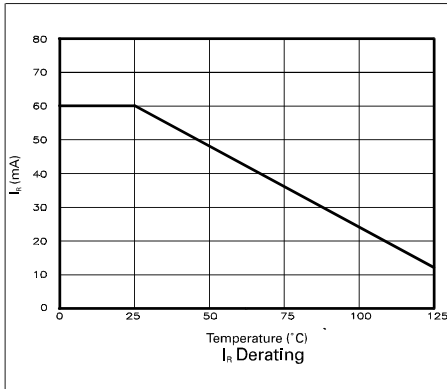

### NOTES

#### (a) Output change with temperature (V<sub>R</sub>)

The absolute maximum difference between the maximum output voltage and the minimum output voltage over the specified temperature range

$$\Delta V_R = V_{max} - V_{min}$$

#### (b) Output temperature coefficient (T<sub>c</sub>V<sub>R</sub>)

The ratio of the output change with temperature to the specified temperature range expressed in ppm/°C

$$T_c V_R = \frac{\Delta V_R \times 10^6}{V_R \times \Delta T} \text{ ppm}/^\circ\text{C}$$

ΔT = Full temperature range

#### (c) Operating current (I<sub>R</sub>)

Maximum operating current must be derated as indicated in maximum ratings.

#### (d) Slope resistance (R<sub>S</sub>)

The slope resistance is defined as :

$$R_S = \frac{\text{change in } V_R}{\text{specified current range}}$$

$$\Delta I = 5 - 0.5 = 4.5 \text{ mA (typically)}$$

#### (e) Line regulation

The ratio of change in output voltage to the change in input voltage producing it.

$$\frac{R_S \times 100}{V_R \times R_{S_{source}}} \% / V$$

# ZRT050

## CONNECTION DIAGRAMS

### SOT223 Package Suffix - G

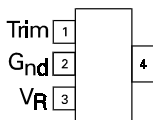

Top View  
Pin 4 floating or connected to pin 2

### TO18 Package Suffix - None

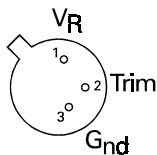

Bottom View -  
Case is internally connected to pin 3

### SO8 Package Suffix - N8

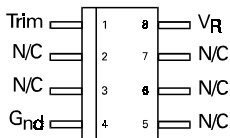

Top View

## ORDERING INFORMATION

Part No	Tol%	Operating Temp.(°C)	Package	Partmark
ZRT050C2	2	0 to 70	TO18	ZRT050C2
ZRT050C1	1	0 to 70	TO18	ZRT050C1
ZRT050A1	1	-55 to 125	TO18	ZRT050A1
ZRT050GC2	2	0 to 70	SOT223	ZRT050C2
ZRT050GC1	1	0 to 70	SOT223	ZRT050C1
ZRT050GA1	1	-55 to 125	SOT223	ZRT050A1
ZRT050N8C2	2	0 to 70	SO8	ZRT050C2
ZRT050N8C1	1	0 to 70	SO8	ZRT050C1
ZRT050N8A1	1	-55 to 125	SO8	ZRT050A1