

# ZXCT1021

## Low offset high-side current monitor

### Description

The ZXCT1021 is a precision high-side current sense monitor. Using this type of device eliminates the need to disrupt the ground plane when sensing a load current.

The ZXCT1021 provides a fixed gain of 10 for applications where minimal sense voltage is required.

The very low offset voltage enables a typical accuracy of 3% for sense voltages of only 10mV,

### Features

- Accurate high-side current sensing
- Output voltage scaling
- 2.5V – 20V supply range
- 25mA quiescent current
- 1% typical accuracy
- SOT23-5 package

giving better tolerances for small sense resistors necessary at higher currents.

The wide input voltage range of 20V down to as low as 2.5V make it suitable for a range of applications. With a minimum operating current of just 25µA, combined with its SOT23-5 package make it suitable for portable battery equipment too.

### Applications

- Battery chargers
- Smart battery packs
- DC motor control
- Over current monitor
- Power management
- Level translating
- Programmable current source

### Pinout information

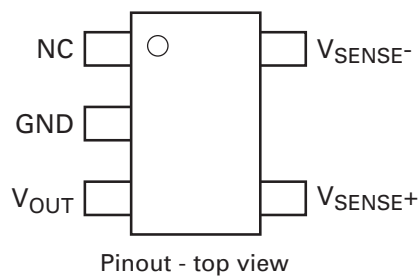

### Typical application circuit

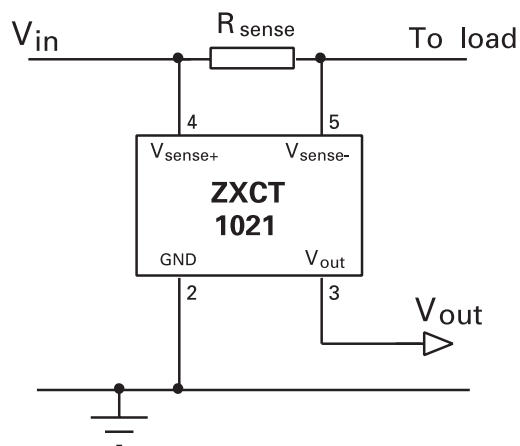

### Ordering information

Order reference	Package	Device marking	Status	Reel size (inches)	Quantity per reel	Tape width (mm)
ZXCT1021E5TA	SOT23-5	1021	Released	7	3000	8

## Absolute maximum ratings

Voltage on any pin with respect to END pin	-0.6V to 20V
$V_{SENSE}$	-0.6V to $V_{IN} + 0.5V$
Operating temperature	-40 to 85°C
Storage temperature	-55 to 150°C
Package power dissipation	( $T_{amb} = 25^{\circ}C$ )
SOT23-5	300mW

## Pinout information

Pin name	Pin function
N/C	Not internally connected
GND	Ground
$V_{OUT}$	Voltage output referenced to GND. Intended to drive high impedance loads
$V_{SENSE-}$	High impedance negative sense voltage input
$V_{SENSE+}$	Supply and positive sense voltage input

# ZXCT1021

Electrical characteristics test conditions  $T_{amb} = 25^{\circ}\text{C}$ ,  $V_{IN} = 15\text{V}$

Symbol	Parameter	Conditions	Limits			Unit
			Min.	Typ.	Max.	
$V_{IN}$	$V_{CC}$ range		2.5		20	V
$V_{OUT}$	Output voltage	$V_{SENSE} = 30\text{mV}$	291	300	309	mV
		$V_{SENSE} = 100\text{mV}$	0.98	1.00	1.02	V
		$V_{SENSE} = 150\text{mV}$	1.47	1.50	1.53	V
$R_{OUT}$	Output resistance		10	15	20	$\text{k}\Omega$
$T_C^{(*)}$	Output voltage temperature coefficient			50	300	ppm
$I_Q$	Ground pin current	$V_{SENSE} = 0\text{V}$		25	35	$\mu\text{A}$
$V_{SENSE}^{(\dagger)}$	Sense voltage	$V_{IN} = 20\text{V}$	0		1.5 <sup>(‡)</sup>	V
$I_{LOAD}$	$V_{SENSE}$ - load pin input current	$V_{SENSE} = 0\text{V}$			100	nA
Acc	Accuracy	$V_{SENSE} = 100\text{mV}$	-2		2	%
Gain	$V_{OUT} / V_{SENSE}$	$V_{SENSE} = 100\text{mV}$	9.8	10	10.2	V/V
BW	Bandwidth	$V_{SENSE} = 10\text{mV}$		300		kHz
		$V_{SENSE} = 100\text{mV}$		2		MHz

**NOTES:**

(\*)  $T_C$  limits are determined by characterization

(†)  $V_{SENSE} = V_{IN} - V_{LOAD}$

(‡) This will be reduced at lower  $V_{IN}$  voltages due to clipping of output voltage.

## Typical characteristics

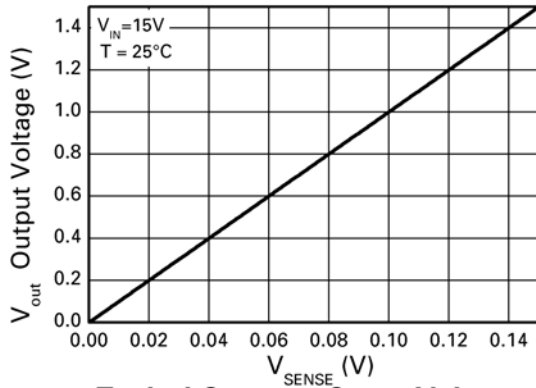

**Typical Output v Sense Voltage**

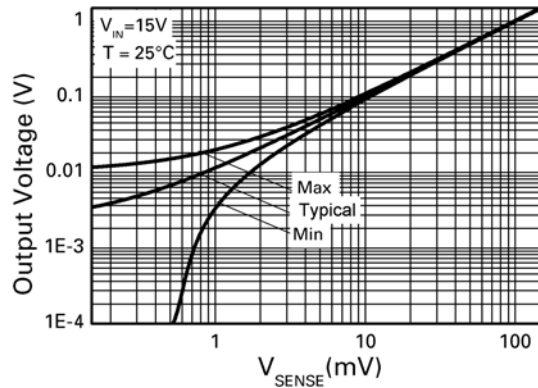

**Vout v Sense Voltage**

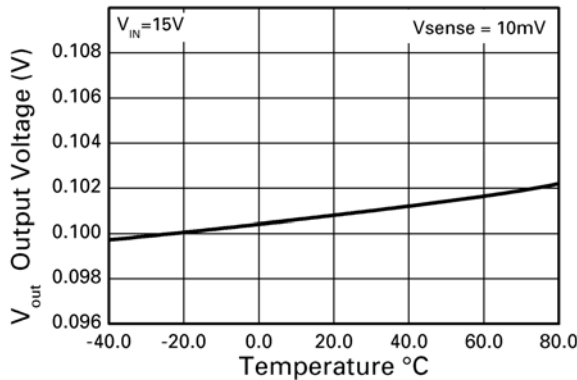

**Output Voltage v Temperature**

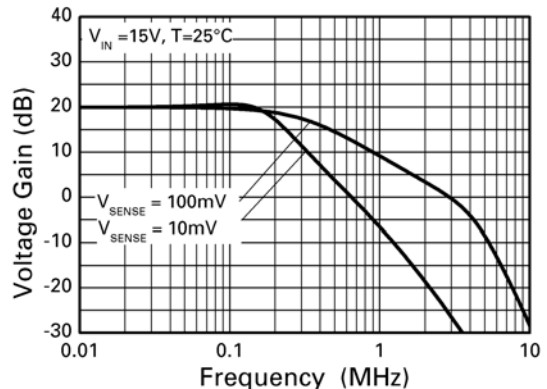

**Frequency Response**

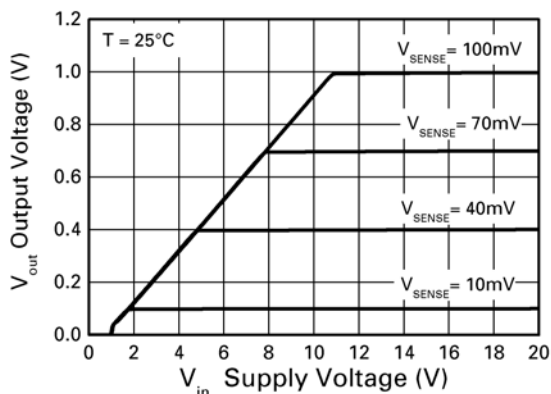

**Transfer Characteristic**

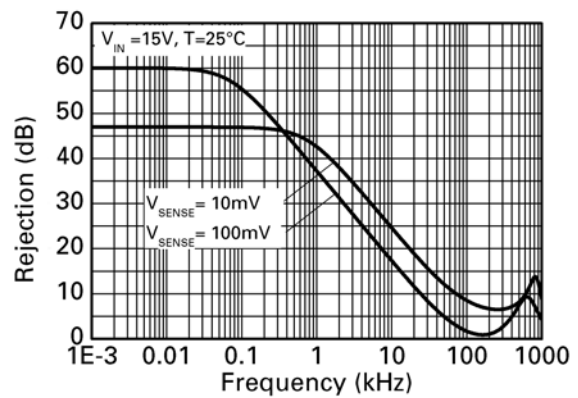

**Common Mode Rejection**

## Typical characteristics

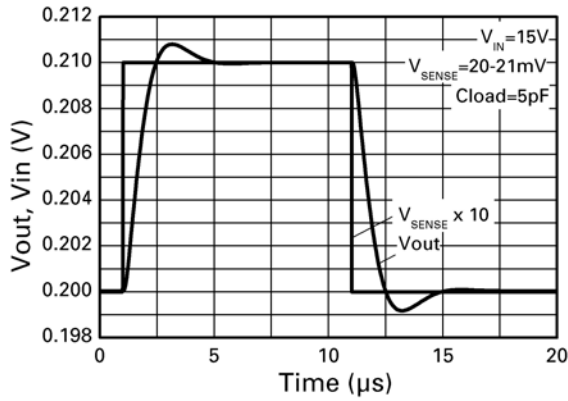

**Small Signal Step Response**

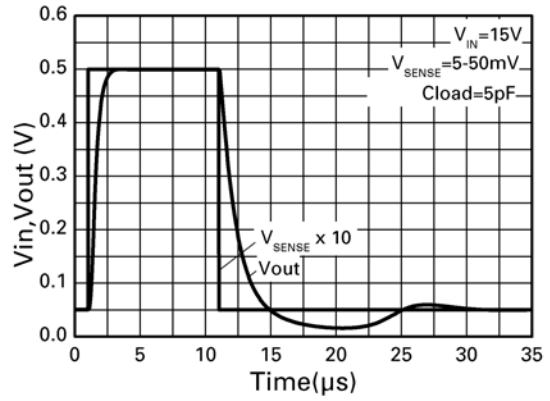

**Large Signal Step Response**

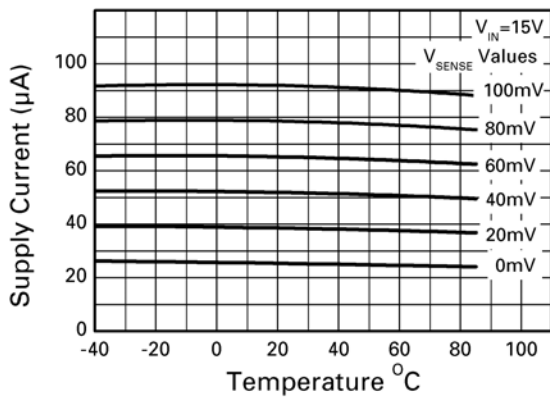

**$I_{supply}$  v Temperature**

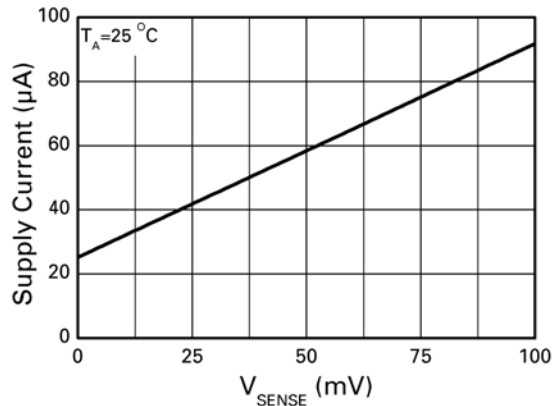

**$I_{supply}$  v  $V_{temp}$**

## Application information

The ZXCT1021 has a fixed dc voltage gain of 100. No external scaling resistors are required for the output. Output voltage is simply defined as:

$$V_{OUT} = 100 \times V_{SENSE} (V)$$

Where  $V_{SENSE} = V_{IN} - V_{LOAD}$

## PCB trace shunt resistor for low cost solution

Figure 1 shows a PCB layout suggestion for a low cost solution where a PCB resistive trace in replacement for a conventional shunt resistor, can be used. The resistor section is 25mm x 0.25mm giving approximately 150m $\Omega$  using 1 oz copper. Smaller resistances can be used if required.

Total circuit solution: 1 component. Shows area of 150m $\Omega$  sense resistor compared to SOT23 package.

Practical tolerance of the PCB resistor will be around 5% depending on manufacturing methods.

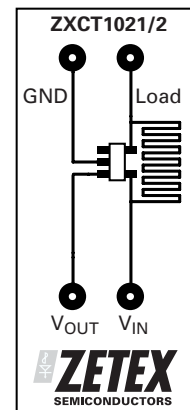
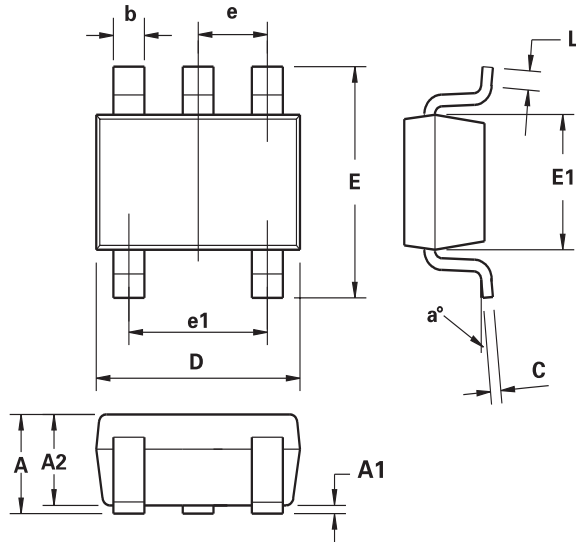

Figure 1 PCB layout suggestion

Intentionally left blank

## Package outline - SOT23-5



DIM	Millimeters		Inches	
	Min.	Max.	Min.	Max.
A	0.90	1.45	0.0354	0.0570
A1	0.00	0.15	0.00	0.0059
A2	0.90	1.30	0.0354	0.0511
b	0.20	0.50	0.0078	0.0196
C	0.09	0.26	0.0035	0.0102
D	2.70	3.10	0.1062	0.1220
E	2.20	3.20	0.0866	0.1181
E1	1.30	1.80	0.0511	0.0708
e	0.95 REF		0.0374 REF	
e1	1.90 REF		0.0748 REF	
L	0.10	0.60	0.0039	0.0236
a°	0°	30°	0°	30°

**Note:** Controlling dimensions are in millimeters. Approximate dimensions are provided in inches

Europe	Americas	Asia Pacific	Corporate Headquarters
Zetex GmbH Streitfeldstraße 19 D-81673 München Germany	Zetex Inc 700 Veterans Memorial Highway Hauppauge, NY 11788 USA	Zetex (Asia Ltd) 3701-04 Metroplaza Tower 1 Hing Fong Road, Kwai Fong Hong Kong	Zetex Semiconductors plc Zetex Technology Park, Chadderton Oldham, OL9 9LL United Kingdom
Telefon: (49) 89 45 49 49 0 Fax: (49) 89 45 49 49 49 europe.sales@zetex.com	Telephone: (1) 631 360 2222 Fax: (1) 631 360 8222 usa.sales@zetex.com	Telephone: (852) 26100 611 Fax: (852) 24250 494 asia.sales@zetex.com	Telephone: (44) 161 622 4444 Fax: (44) 161 622 4446 hq@zetex.com

For international sales offices visit [www.zetex.com/offices](http://www.zetex.com/offices)

Zetex products are distributed worldwide. For details, see [www.zetex.com/salesnetwork](http://www.zetex.com/salesnetwork)

This publication is issued to provide outline information only which (unless agreed by the company in writing) may not be used, applied or reproduced for any purpose or form part of any order or contact or be regarded as a representation relating to the products or services concerned. The company reserves the right to alter without notice the specification, design, price or conditions of supply of any product or service.