

**AUTOMOTIVE GRADE 60/40V HIGH-SIDE CURRENT MONITOR**

**Description**

The ZXCT1080Q and ZXCT1081Q are high side current sense monitors with a voltage output and a fixed gain of 10. Using this device eliminates the need to disrupt the ground plane when sensing a load current.

The wide input voltage range of 60V and 40V, respectively, down to as low as 3V make it suitable for a range of automotive applications with 60V and 40V load dump withstand capabilities.

The separate supply pin ( $V_{CC}$ ) allows the device to continue functioning under short circuit conditions.

The ZXCT1080Q and ZXCT1081Q have an extended ambient operating temperature range of  $-40^{\circ}\text{C}$  to  $125^{\circ}\text{C}$  enabling it to be used in a wide range of automotive applications including.

The ZXCT1080Q and ZXCT1081Q have been qualified to AEC-Q100 Grade 1 and are Automotive Grade supporting PPAPs.

**Pin Assignments**

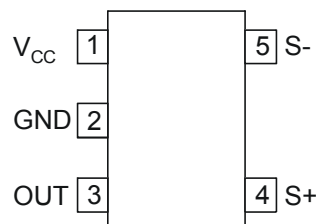

**Features**

- Accurate high-side current sensing
  - ZXCT1080Q : 3V to 60V continuous high side voltage
  - ZXCT1081Q : 3V to 40V continuous high side voltage
- $-40^{\circ}\text{C}$  to  $+125^{\circ}\text{C}$  temperature range
- Output voltage scaling x10
- 4.5V to 12V  $V_{CC}$  range
- Low quiescent current:
  - 80 $\mu\text{A}$  supply pin
  - 27 $\mu\text{A}$   $I_{S+}$
- Green Molding in SOT25
  - **Totally Lead-Free & Fully RoHS Compliant (Notes 1 & 2)**
  - **Halogen and Antimony Free. "Green" Device (Note 3)**
- Automotive Grade
  - **Qualified to AEC-Q100 Standards for High Reliability**
  - **PPAP Capable (Note 4)**

**Applications**

- Automotive current measurement
- Battery management
- Over-current measurement

Notes: 1. No purposely added lead. Fully EU Directive 2002/95/EC (RoHS) & 2011/65/EU (RoHS 2) compliant.  
 2. See [http://www.diodes.com/quality/lead\\_free.html](http://www.diodes.com/quality/lead_free.html) for more information about Diodes Incorporated's definitions of Halogen- and Antimony-free, "Green" and Lead-free.  
 3. Halogen- and Antimony-free "Green" products are defined as those which contain <900ppm bromine, <900ppm chlorine (<1500ppm total Br + Cl) and <1000ppm antimony compounds.  
 4. Automotive products are AEC-Q100 qualified and are PPAP capable. Automotive, AEC-Q100 and standard products are electrically and thermally the same, except where specified. For more information, please refer to [http://www.diodes.com/quality/product\\_compliance\\_definitions/](http://www.diodes.com/quality/product_compliance_definitions/).

**Typical Application Circuit**

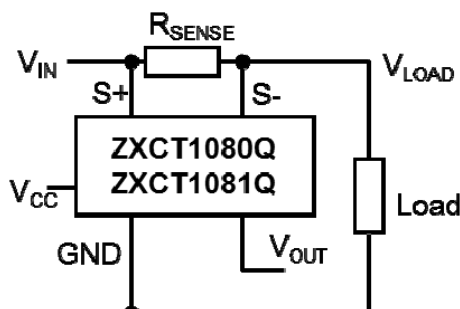

## Pin Descriptions

Pin	Name	Function		
		Common	ZXCT1080Q	ZXCT1081Q
1	V <sub>CC</sub>	This is the analogue supply and provides power to internal circuitry	—	—
2	GND	Ground pin	—	—
3	OUT	Output voltage pin. NMOS source follower with 20µA bias to ground	—	—
4	S+	This is the positive input of the current monitor. The current through this pin varies with differential sense voltage	Input range from 60V down to 3V	Input range from 40V down to 3V
5	S-	This is the negative input of the current monitor.		

## Absolute Maximum Ratings (@T<sub>A</sub> = +25°C, unless otherwise specified.)

Parameter		Rating	Unit
Continuous voltage on S- and S+	ZXCT1080Q (Note 5)	-0.6 to 65	V
	ZXCT1081Q (Note 5)	-0.6 to 45	
Transient voltage on S- and S+	ZXCT1081Q (Note 5)	-0.6 to 65	V
Voltage on all other pins		-0.6 to +14	V
Differential sense voltage, V <sub>SENSE</sub> (Note 6)		800	mV
Operating temperature		-40 to +125	°C
Storage Temperature		-55 to +150	°C
Maximum Junction Temperature		+125	°C
Package Power Dissipation (Note 7)		300 (@ T <sub>A</sub> = +25°C)	mW
<b>ESD Ratings</b>			
HBM ESD	Human Body Model	1000	V
MM ESD	Machine Model	150	V
CDM ESD	Charged Device Model	TBD	V

Caution: Stresses greater than the 'Absolute Maximum Ratings' specified above, may cause permanent damage to the device. These are stress ratings only; functional operation of the device at conditions between maximum recommended operating conditions and absolute maximum ratings is not implied. Device reliability may be affected by exposure to absolute maximum rating conditions for extended periods of time.

Semiconductor devices are ESD sensitive and may be damaged by exposure to ESD events. Suitable ESD precautions should be taken when handling and transporting these devices.

- Notes:
- ZXCT1080 has a maximum transient and continuous voltage of 65V on the S+ and S- pin. The ZXCT1081 has a maximum continuous of 45V, it however can withstand transient up to 65V.
  - V<sub>SENSE</sub> is defined as the differential voltage between S+ and S- pins
  - Assumes  $\theta_{JA} = 420^{\circ}\text{C/W}$

## Recommended Operating Conditions

Symbol	Parameter	Min	Max	Units
V <sub>IN</sub>	Common-mode Sense+ Input Range	3	60	V
			40	
V <sub>CC</sub>	Supply Voltage Range	4.5	12	V
V <sub>SENSE</sub>	Differential Sense Input Voltage Range	0	0.15	V
V <sub>OUT</sub>	Output Voltage Range (Note 8)	0	1.5	V
T <sub>A</sub>	Ambient Temperature Range	-40	+125	°C

Note: 8. Based on 10x V<sub>SENSE</sub>

**Electrical Characteristics** (@  $V_{IN} = V_{S+} = 12V$ ,  $V_{CC} = 5V$ ,  $V_{SENSE}$  (Note 6) = 100mV,  $T_A = +25^\circ C$ , unless otherwise specified.)

Symbol	Parameter	Conditions	$T_A$	Min	Typ	Max	Units	
$I_{CC}$	$V_{CC}$ Supply Current	$V_{CC} = 12V$ , $V_{SENSE} = 0V$	ZXCT1080Q ZXCT1081Q	+25°C	40	80	120	$\mu A$
			ZXCT1080Q	Full range	—	—	145	
$I_{S+}$	S+ Input Current	$V_{SENSE} = 0V$	ZXCT1080Q	+25°C	15	27	42	$\mu A$
			ZXCT1081Q		15	30	60	
			ZXCT1080Q	Full range	—	—	60	
$I_{S-}$	S- Input Current	$V_{SENSE} = 0V$	ZXCT1080Q	+25°C	15	40	80	nA
			ZXCT1081Q		10			
$V_{O(0)}$	Zero $V_{SENSE}$ error (Note 9)		ZXCT1080Q ZXCT1081Q	+25°C	0	—	35	mV
$V_{O(10)}$	Output Offset Voltage (Note 10)	$V_{SENSE} = 10mV$	ZXCT1080Q	+25°C	-25	—	+25	mV
			ZXCT1081Q		-30		+30	
			ZXCT1080Q	Full range	-55	—	+55	
Gain	$\Delta V_{OUT}/\Delta V_{SENSE}$	$V_{SENSE} = 10mV$ to 150mV	ZXCT1080Q	+25°C	9.9	10	10.1	V/V
			ZXCT1081Q		9.95		10.05	
			ZXCT1080Q	Full range	9.8	—	10.2	
$V_{OUT TC}$	$V_{OUT}$ variation with temperature	—	—	—	30	—	ppm/°C	
$A_{CC}$	Total output error	—	—	-3	—	3	%	
$I_{OH}$	Output Source Current	$\Delta V_{OUT} = -30mV$	—	—	1	—	mA	
$I_{OL}$	Output Sink Current	$\Delta V_{OUT} = +30mV$	—	—	20	—	$\mu A$	
PSRR	$V_{CC}$ Supply Rejection Ratio	$V_{CC} = 4.5V$ to 12V	—	54	60	—	dB	
CMRR	Common-Mode Sense Rejection Ratio	$V_{S+} = 60V$ to 3V	ZXCT1080Q	—	68	80	—	dB
		$V_{S+} = 40V$ to 3V	ZXCT1081Q		60	75		
BW	-3dB small signal bandwidth	$V_{SENSE (AC)} = 10mV_{pp}$	—	—	500	—	kHz	

- Notes: 6.  $V_{SENSE} = "V_{S+}" - "V_{S-}"$   
9. The ZXCT1080Q/81Q operates from a positive power rail and the internal voltage-current converter current flow is unidirectional; these result in the output offset voltage for  $V_{SENSE} = 0V$  always being positive.  
10. For  $V_{SENSE} > 10mV$ , the internal voltage-current converter is fully linear. This enables a true offset to be defined and used.  $V_{O(10)}$  is expressed as the variance about an output voltage of 100mV.

**Typical Characteristics** (@  $V_{IN} = 12V$ ,  $V_{CC} = 5V$ ,  $V_{SENSE+} = 12V$ ,  $V_{SENSE} = 100mV$ ,  $T_A = +25^\circ C$ , unless otherwise specified.)

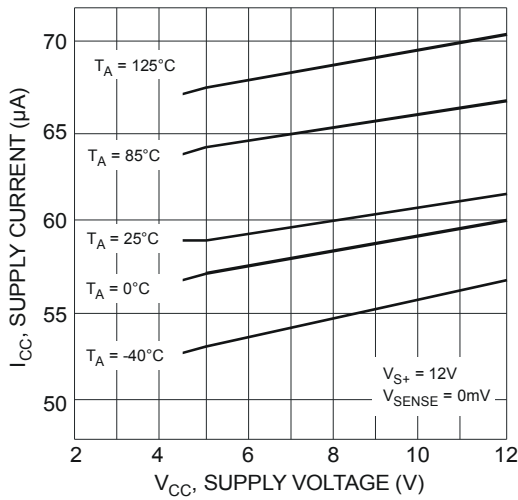

Fig. 1 Supply Current

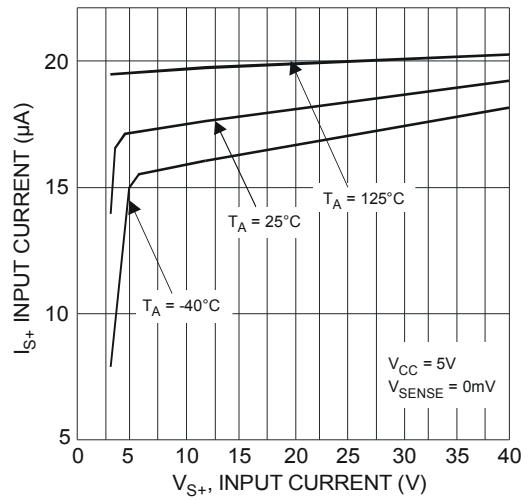

Fig. 2 Input Current

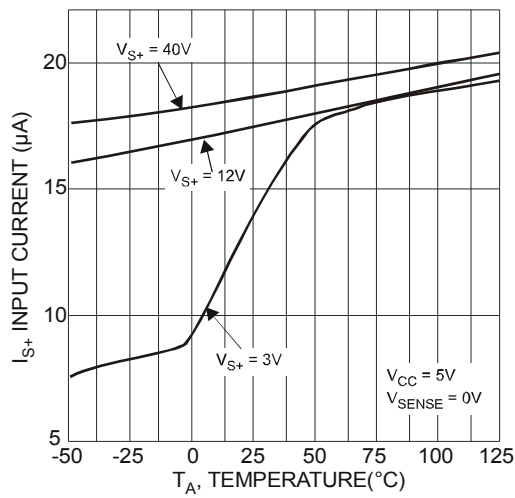

Fig. 3 Input Current

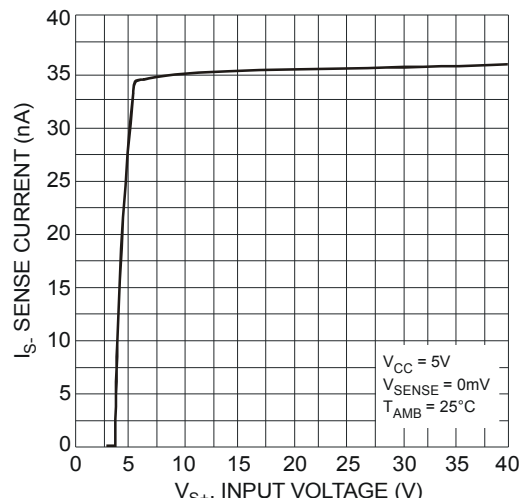

Fig. 4 Sense Current

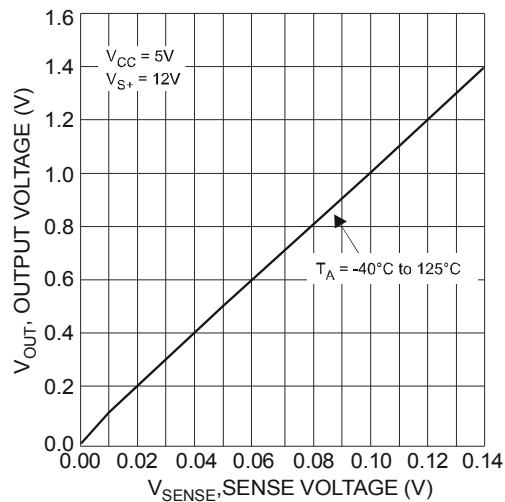

Fig. 5 Output Voltage

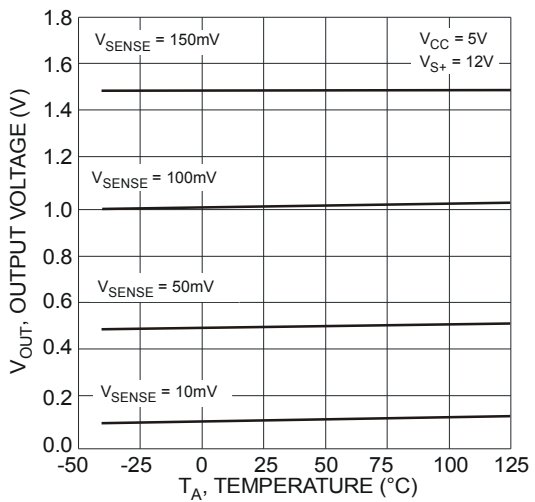

Fig. 6 Output Voltage

**Typical Characteristics** (cont.) (@  $V_{IN} = 12V$ ,  $V_{CC} = 5V$ ,  $V_{SENSE+} = 12V$ ,  $V_{SENSE} = 100mV$ ,  $T_A = +25^\circ C$ , unless otherwise specified.)

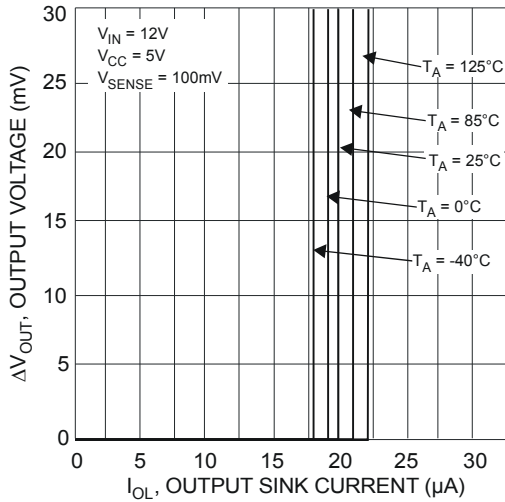

Fig. 7 Output Current Sink

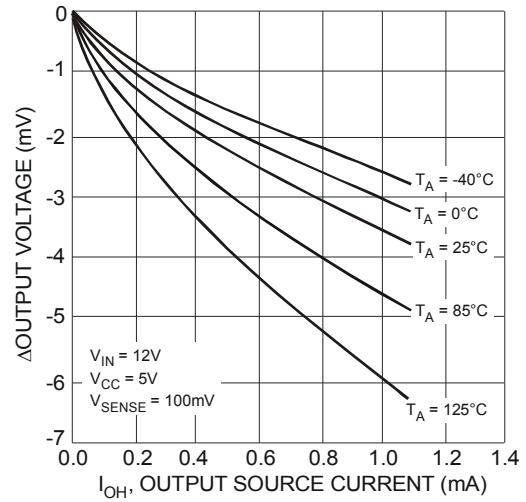

Fig. 8 Output Current Source

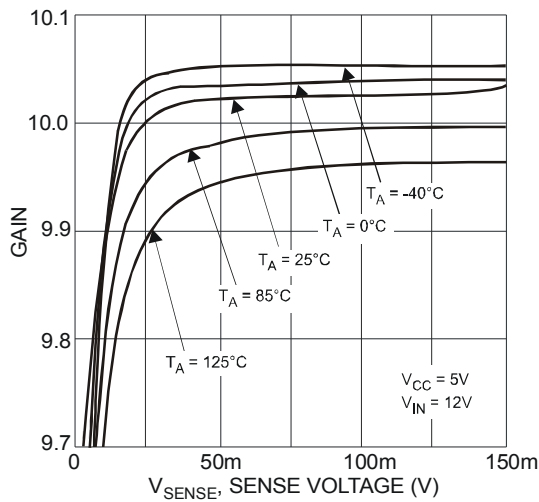

Fig. 9 Differential gain

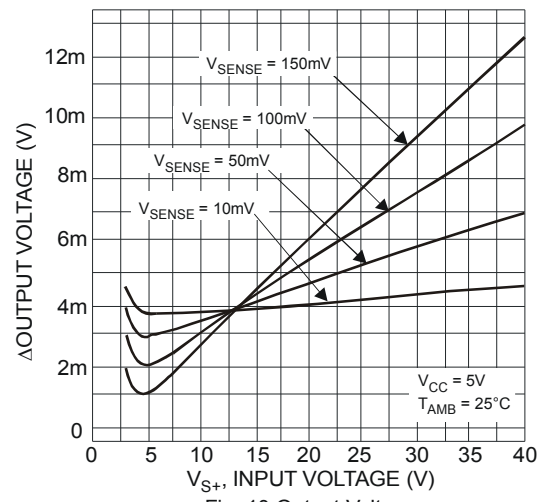

Fig. 10 Output Voltage

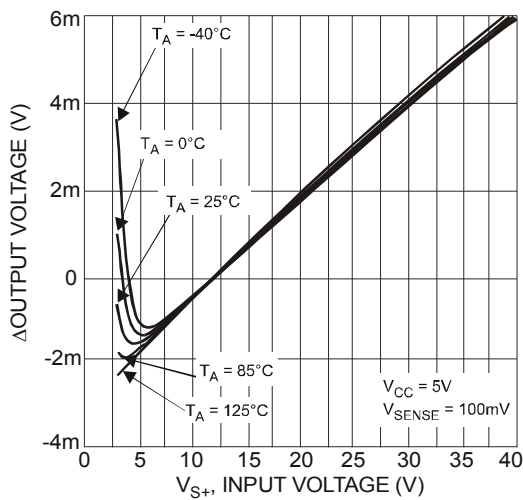

Fig. 11 Output Voltage

**Typical Characteristics** (cont.) (@  $V_{IN} = 12V$ ,  $V_{CC} = 5V$ ,  $V_{SENSE+} = 12V$ ,  $V_{SENSE} = 100mV$ ,  $T_A = +25^{\circ}C$ , unless otherwise specified.)

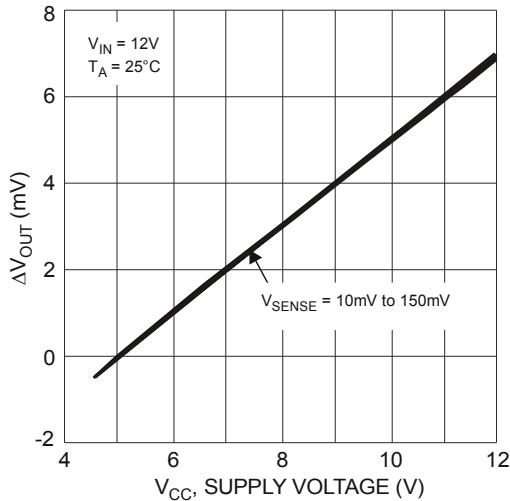

Fig. 12 Normalized Output Voltage

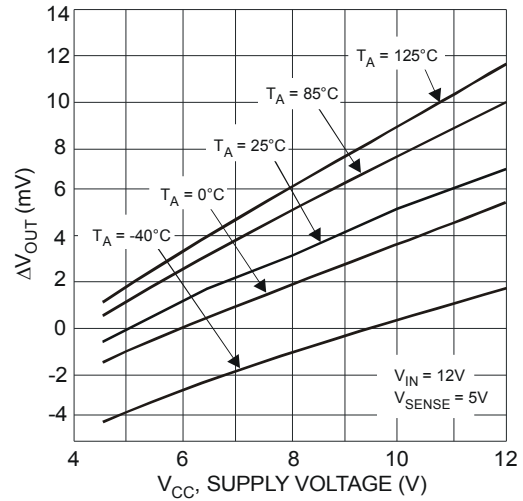

Fig. 13 Normalized Output Voltage

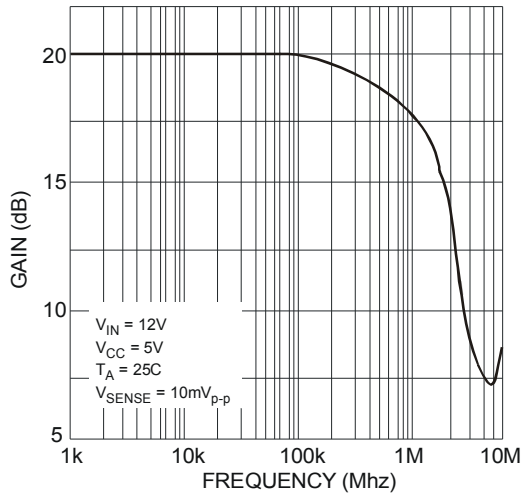

Fig. 14 Small Signal Bandwidth

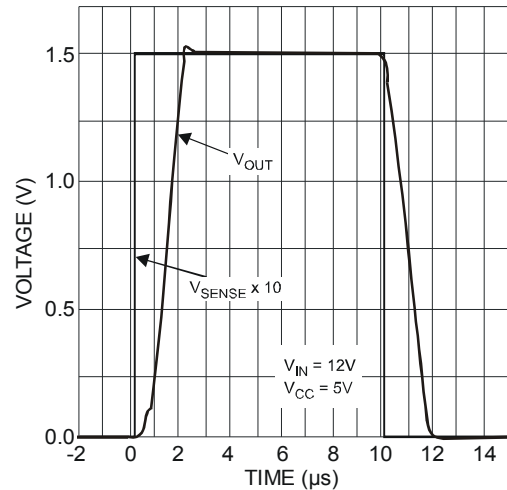

Fig. 15 Large Signal Pulse Response

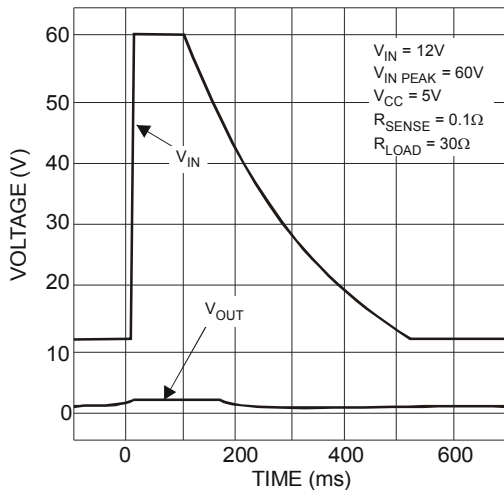

Fig. 16 Load Dump Waveform

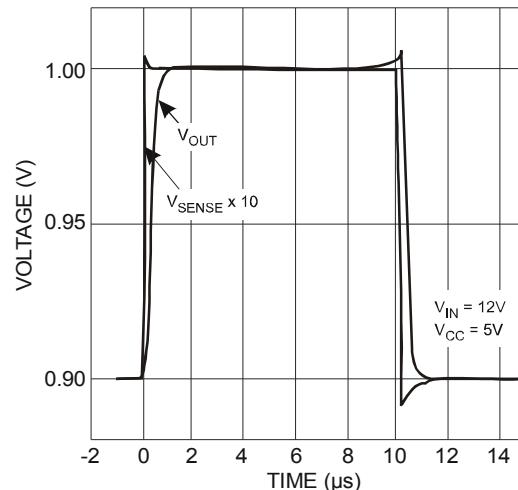

Fig. 17 Small Signal Pulse Response

**Typical Characteristics** (cont.) (@  $V_{IN} = 12V$ ,  $V_{CC} = 5V$ ,  $V_{SENSE+} = 12V$ ,  $V_{SENSE-} = 100mV$ ,  $T_A = +25^\circ C$ , unless otherwise specified.)

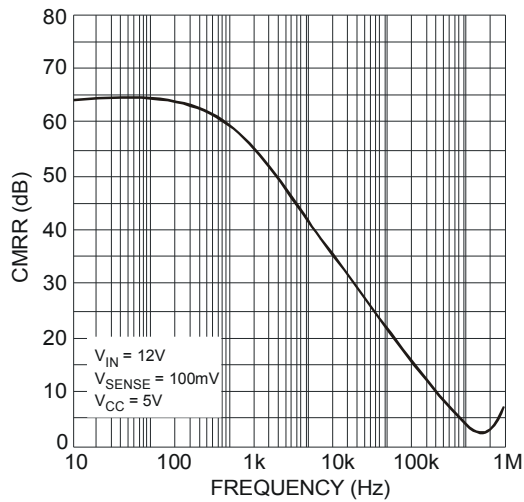

Fig. 18 Common Mode Rejection

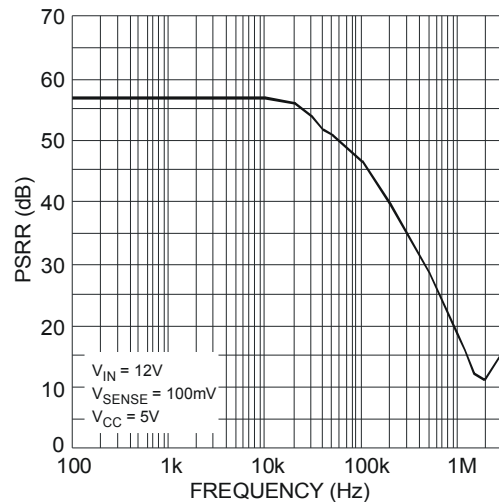

Fig. 19 Supply Rejection

## Application Information

The ZXCT1080Q and ZXCT1081Q have been designed to allow them to operate with 5V supply rails while sensing common mode signals up to 60V and 40V respectively. This makes it well suited to a wide range of current measuring/monitoring applications that require the interface to 5V systems while sensing much higher voltages.

To allow this its  $V_{CC}$  pin can be used independently of S+.

Figure 20 shows the basic configuration of the ZXCT1080Q and ZXCT1081Q.

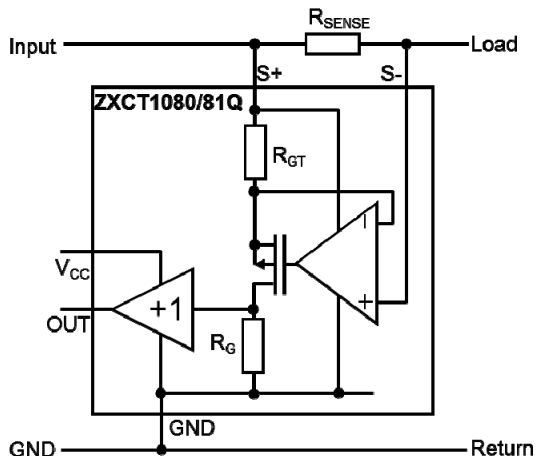

**Fig. 20 Typical Configuration of ZXCT1080Q/81Q**

Load current from the input is drawn through  $R_{SENSE}$  developing a voltage  $V_{SENSE}$  across the inputs of the ZXCT1080Q/81Q.

The internal amplifier forces  $V_{SENSE}$  across internal resistance  $R_{GT}$  causing a current to flow through MOSFET M1. This current is then converted to a voltage by  $R_G$ . A ratio of 10:1 between  $R_G$  and  $R_{GT}$  creates the fixed gain of 10. The output is then buffered by the unity gain buffer.

The gain equation of the ZXCT1080Q and ZXCT1081Q is:

$$V_{OUT} = I_L R_{SENSE} \frac{R_G}{R_{GT}} \times 1 = I_L \times R_{SENSE} \times 10$$

The maximum recommended differential input voltage,  $V_{SENSE}$ , is 150mV; it will however withstand voltages up to 800mV. This can be increased further by the inclusion of a resistor,  $R_{LIM}$ , between S- pin and the load (see figure 21); typical value is of the order of 10k.

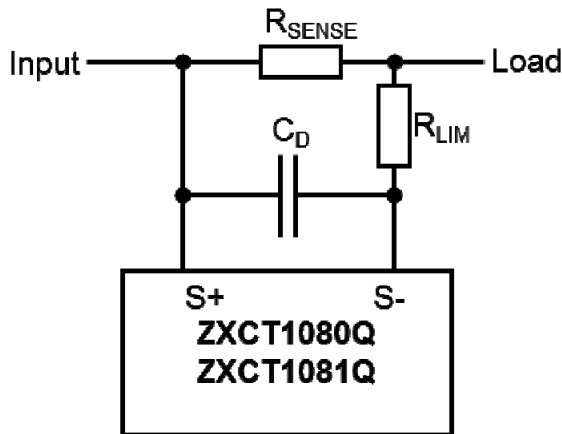

**Fig. 21 Protection/Error Sources for ZXCT1080**

Capacitor  $C_D$  provides high frequency transient decoupling when used with  $R_{LIM}$ ; typical values are of the order 10pF.



## Application Information (cont.)

For best performance  $R_{SENSE}$  should be connected as close to the S+ (and SENSE) pins; minimizing any series resistance with  $R_{SENSE}$ .

When choosing appropriate values for  $R_{SENSE}$  a compromise must be reached between in-line signal loss (including potential power dissipation effects) and small signal accuracy.

Higher values for  $R_{SENSE}$  gives better accuracy at low load currents by reducing the inaccuracies due to internal offsets. For best operation the ZXCT1080Q/81Q has been designed to operate with  $V_{SENSE}$  of the order of 50mV to 150mV.

Current monitors' basic configuration is that of a unipolar voltage to current to voltage converter powered from a single supply rail. The internal amplifier at the heart of the current monitor may well have a bipolar offset voltage but the output cannot go negative; this results in current monitors saturating at very low sense voltages.

As a result of this phenomenon the ZXCT1080Q/81Q has been specified to operate in a linear manner over a  $V_{SENSE}$  range of 10mV to 150mV range, however it will still be monotonic down to  $V_{SENSE}$  of 0V.

It is for this very reason that Diodes has specified an input offset voltage ( $V_{O(10)}$ ) at 10mV. The output voltage for any  $V_{SENSE}$  voltage from 10mV to 150mV can be calculated as follows:

$$V_{OUT} = (V_{SENSE}) \times G + V_{(10)}$$

Alternatively the load current can be expressed as:

$$I_L = \frac{(V_{OUT} - V_{O(10)})}{G \times R_{SENSE}}$$

**ZXCT1080Q/ ZXCT1081Q**

**Ordering Information**

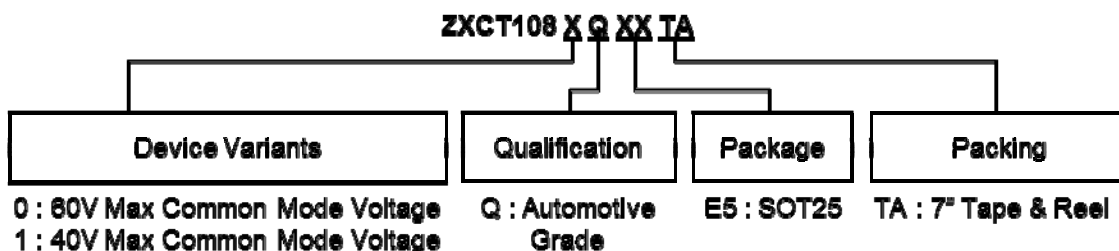

Order Reference	Package	Package Code	Identification Code	Packing: 7" Tape and Reel			Qualification Grade
				Quantity	Tape Width	Part Number Suffix	
ZXCT1080QE5TA	SOT25	E5	1080	3000	8	TA	Automotive Grade
ZXCT1081QE5TA	SOT25	E5	1081	3000	8	TA	Automotive Grade

**Marking Information**

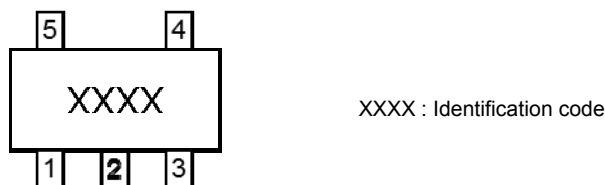

**Package Outline Dimensions** (All Dimensions in mm)

Please see AP02002 at <http://www.diodes.com/datasheets/ap02002.pdf> for latest version.

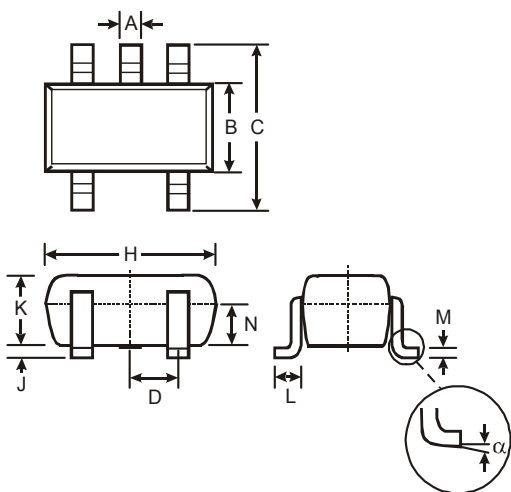

SOT25			
Dim	Min	Max	Typ
A	0.35	0.50	0.38
B	1.50	1.70	1.60
C	2.70	3.00	2.80
D	—	—	0.95
H	2.90	3.10	3.00
J	0.013	0.10	0.05
K	1.00	1.30	1.10
L	0.35	0.55	0.40
M	0.10	0.20	0.15
N	0.70	0.80	0.75
$\alpha$	0°	8°	—
<b>All Dimensions in mm</b>			

**Suggested Pad Layout** (All Dimensions in mm)

Please see AP02001 at <http://www.diodes.com/datasheets/ap02001.pdf> for latest version.

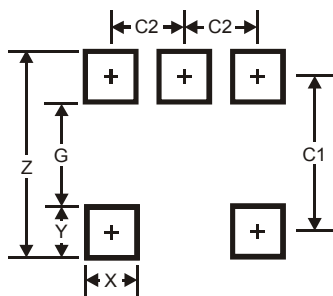

Dimensions	Value (in mm)
Z	3.20
G	1.60
X	0.55
Y	0.80
C1	2.40
C2	0.95

**IMPORTANT NOTICE**

DIODES INCORPORATED MAKES NO WARRANTY OF ANY KIND, EXPRESS OR IMPLIED, WITH REGARDS TO THIS DOCUMENT, INCLUDING, BUT NOT LIMITED TO, THE IMPLIED WARRANTIES OF MERCHANTABILITY AND FITNESS FOR A PARTICULAR PURPOSE (AND THEIR EQUIVALENTS UNDER THE LAWS OF ANY JURISDICTION).

Diodes Incorporated and its subsidiaries reserve the right to make modifications, enhancements, improvements, corrections or other changes without further notice to this document and any product described herein. Diodes Incorporated does not assume any liability arising out of the application or use of this document or any product described herein; neither does Diodes Incorporated convey any license under its patent or trademark rights, nor the rights of others. Any Customer or user of this document or products described herein in such applications shall assume all risks of such use and will agree to hold Diodes Incorporated and all the companies whose products are represented on Diodes Incorporated website, harmless against all damages.

Diodes Incorporated does not warrant or accept any liability whatsoever in respect of any products purchased through unauthorized sales channel.

Should Customers purchase or use Diodes Incorporated products for any unintended or unauthorized application, Customers shall indemnify and hold Diodes Incorporated and its representatives harmless against all claims, damages, expenses, and attorney fees arising out of, directly or indirectly, any claim of personal injury or death associated with such unintended or unauthorized application.

Products described herein may be covered by one or more United States, international or foreign patents pending. Product names and markings noted herein may also be covered by one or more United States, international or foreign trademarks.

This document is written in English but may be translated into multiple languages for reference. Only the English version of this document is the final and determinative format released by Diodes Incorporated.

**LIFE SUPPORT**

Diodes Incorporated products are specifically not authorized for use as critical components in life support devices or systems without the express written approval of the Chief Executive Officer of Diodes Incorporated. As used herein:

- A. Life support devices or systems are devices or systems which:
  - 1. are intended to implant into the body, or
  - 2. support or sustain life and whose failure to perform when properly used in accordance with instructions for use provided in the labeling can be reasonably expected to result in significant injury to the user.
- B. A critical component is any component in a life support device or system whose failure to perform can be reasonably expected to cause the failure of the life support device or to affect its safety or effectiveness.

Customers represent that they have all necessary expertise in the safety and regulatory ramifications of their life support devices or systems, and acknowledge and agree that they are solely responsible for all legal, regulatory and safety-related requirements concerning their products and any use of Diodes Incorporated products in such safety-critical, life support devices or systems, notwithstanding any devices- or systems-related information or support that may be provided by Diodes Incorporated. Further, Customers must fully indemnify Diodes Incorporated and its representatives against any damages arising out of the use of Diodes Incorporated products in such safety-critical, life support devices or systems.

Copyright © 2014, Diodes Incorporated

[www.diodes.com](http://www.diodes.com)