

ZXTR2005P5

**100V INPUT, 5V 40mA REGULATOR TRANSISTOR
POWERDI®5**

Description

The ZXTR2005P5 monolithically integrates a transistor, Zener diode and resistor to function as a high voltage linear regulator. The device regulates with a 5V nominal output at 15mA. It is designed for use in high voltage applications where standard linear regulators cannot be used. This function is fully integrated into a PowerDI-5 package, minimizing PCB area and reducing number of components when compared with a multi-chip discrete solution.

Features

- Series Linear Regulator Using Emitter-Follower Stage
- Input Voltage = 10V to 100V
- Output Voltage = 5V ± 10%
- Fully integrated into a PowerDI-5 package
- **Totally Lead-Free & Fully RoHS compliant (Notes 1 & 2)**
- **Halogen and Antimony Free. "Green" Device (Note 3)**
- **Qualified to AEC-Q101 Standards for High Reliability**

Applications

Supply voltage regulation in:

- Networking
- Telecom
- Power Over Ethernet (PoE)

Mechanical Data

- Case: PowerDI-5
- Case Material: Molded Plastic. "Green" Molding Compound.
- UL Flammability Rating 94V-0
- Moisture Sensitivity: Level 1 per J-STD-020
- Terminals: Finish - Matte Tin Plated Leads, Solderable per MIL-STD-202, Method 208
- Weight: 0.100 grams (approximate)

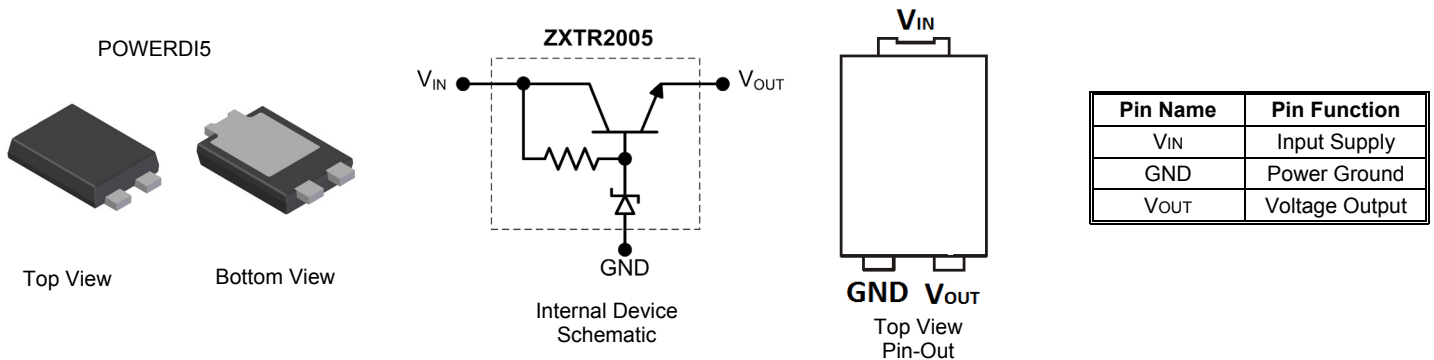

Ordering Information (Note 4)

Product	Package	Marking	Reel size (inches)	Tape width (mm)	Quantity per reel
ZXTR2005P5-13	PowerDI-5	ZXTR2005	13	16	5,000

- Notes:
1. No purposely added lead. Fully EU Directive 2002/95/EC (RoHS) & 2011/65/EU (RoHS 2) compliant.
 2. See http://www.diodes.com/quality/lead_free.html for more information about Diodes Incorporated's definitions of Halogen and Antimony free, "Green" and Lead-Free.
 3. Halogen and Antimony free "Green" products are defined as those which contain <900ppm bromine, <900ppm chlorine (<1500ppm total Br + Cl) and <1000ppm antimony compounds.
 4. For packaging details, go to our website at <http://www.diodes.com/products/packages.html>

Marking Information



- ZXTR2005 = Product Type Marking Code
- = Manufacturers' Code Marking
- K = Factory Designator
- YYWW = Date Code Marking
- YY = Last Two Digits of Year (ex: 14 for 2014)
- WW = Week code (01 to 53)

Absolute Maximum Ratings (Voltage relative to GND, @T_A = +25°C, unless otherwise specified.)

Characteristic	Symbol	Value	Unit
Input Supply Voltage	V _{IN}	-0.3 to 100	V
Continuous Input & Output Current	I _{IN} , I _{OUT}	360	mA
Peak Pulsed Input & Output Current	I _{IM} , I _{OM}	2	A
Maximum Voltage applied to V _{OUT}	V _{OUT(max)}	11	V

Maximum Current at V_{IN} = 48V (@T_A = +25°C, unless otherwise specified.)

Characteristic	Symbol	Value	Unit
Continuous Output Current (Note 7)	I _{OUT}	42	mA
Pulsed Output Current (Note 8)	I _{OM}	740	mA
		150 (Note 9)	

Thermal Characteristics

Characteristic	Symbol	Value	Unit
Power Dissipation (Note 5)	P _D	1.82 (Note 6)	W
		0.94	
Thermal Resistance, Junction to Ambient (Note 5)	R _{θJA}	55 (Note 6)	°C/W
		107	
Thermal Resistance, Junction to Lead (Note 10)	R _{θJL}	20	°C
Thermal Resistance, Junction to Case (Note 10)	R _{θJC}	17.8	
Recommended Operating Junction Temperature Range	T _J	-40 to +125	°C
Maximum Operating Junction and Storage Temperature Range	T _J , T _{STG}	-65 to +150	

ESD Ratings (Note 11)

Characteristics	Symbols	Value	Unit	JEDEC Class
Electrostatic Discharge – Human Body Model	ESD HBM	4000	V	3A
Electrostatic Discharge – Machine Model	ESD MM	400	V	C

- Notes:
- For a device mounted with the exposed V_{IN} pad on 50mm x 50mm 1oz copper that is on a single-sided 1.6mm FR4 PCB; device is measured under still air conditions while operating in steady-state.
 - Same as Note 5, except mounted on 15mm x 15mm 1oz copper.
 - Same as Note 5, while operating at V_{IN} = 48V. Refer to Safe Operating Area for other input voltages.
 - Same as Note 5, except measured with a single pulse width = 100μs and V_{IN} = 48V.
 - Same as Note 5, except measured with a single pulse width = 10ms and V_{IN} = 48V.
 - R_{θJL} = Thermal resistance from junction to solder-point (on the exposed V_{IN} pad).
R_{θJC} = Thermal resistance from junction to the top of case.
 - Refer to JEDEC specification JESD22-A114 and JESD22-A115.

Thermal Characteristics and Derating Information

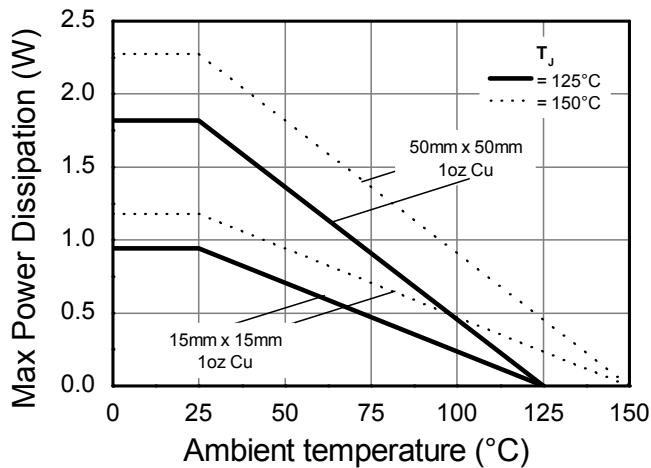

Derating Curve

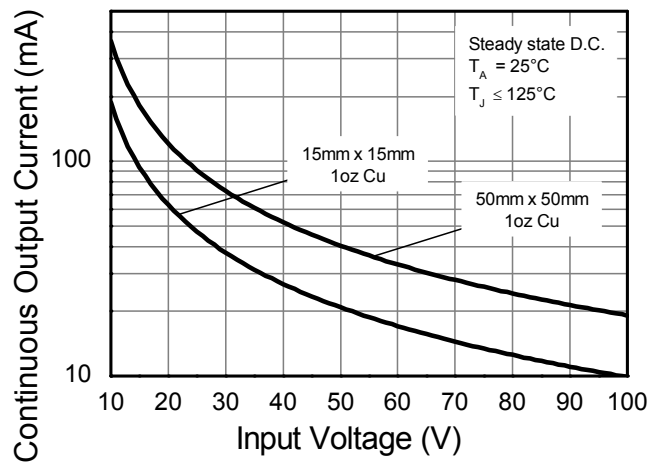

Safe Operating Area

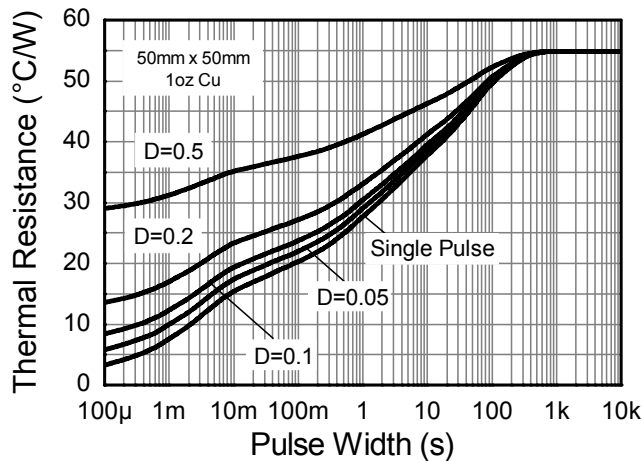

Transient Thermal Impedance

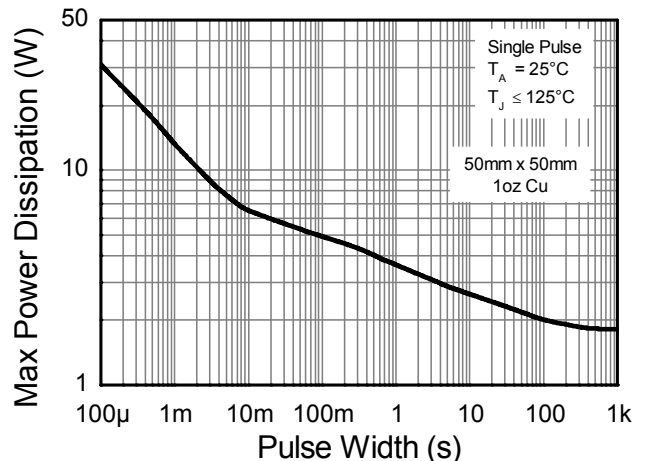

Pulse Power Dissipation

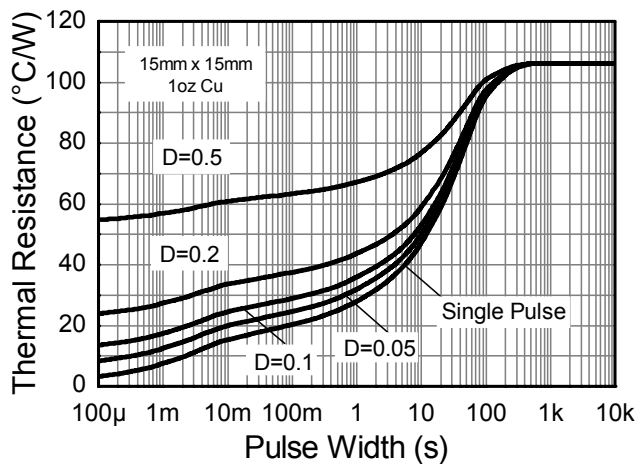

Transient Thermal Impedance

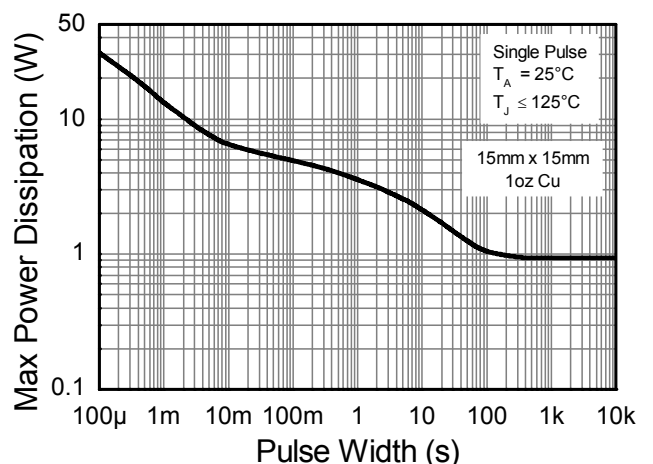

Pulse Power Dissipation

Electrical Characteristics (@T_A = +25°C, unless otherwise specified.)

Characteristic	Symbol	Min	Typ	Max	Unit	Test Condition
Output Voltage (Note 12)	V _{OUT}	4.5	5.0	5.5	V	V _{IN} = 48V, I _{OUT} = 15mA
Line Regulation (Notes 12 & 13)	ΔV _{OUT}	—	195	300	mV	V _{IN} = 10 to 72V, I _{OUT} = 15mA
Temperature Coefficient	ΔV _{OUT} /ΔT	—	7.0	—	mV/°C	T _J = -40°C to +125°C V _{IN} = 48V, I _{OUT} = 15mA
Load Regulation (Notes 12 & 14)	ΔV _{OUT}	—	-185 -205	-350 -400	mV	I _{OUT} = 0.1 to 30mA, V _{IN} = 48V I _{OUT} = 0.1 to 100mA, V _{IN} = 48V
Minimum Value of Input Voltage Required to Maintain Line Regulation	V _{IN(MIN)}	10	—	—	V	—
Quiescent Current	I _Q	—	260 550	500 900	μA	V _{IN} = 48V, I _{OUT} = 10μA V _{IN} = 100V, I _{OUT} = 10μA
Power Supply Rejection Ratio	ΔV _{IN} /ΔV _{OUT}	—	45	—	dB	C _{OUT} = 100nF, I _{OUT} = 15mA, V _{OUT} = 5V, V _{IN} = 10 to 100V, f = 100Hz

- Notes:
- 12. Measured under pulsed conditions. Pulse width ≤ 300μs. Duty cycle ≤ 2%.
 - 13. Line regulation ΔV_{OUT} = V_{OUT}(@ V_{IN} = 72V) – V_{OUT}(@ V_{IN} = 15V)
 - 14. Load regulation ΔV_{OUT} = V_{OUT}(@ I_{OUT} = 30mA) – V_{OUT}(@ I_{OUT} = 0.1mA)
ΔV_{OUT} = V_{OUT}(@ I_{OUT} = 100mA) – V_{OUT}(@ I_{OUT} = 0.1mA)

Typical Application Circuit

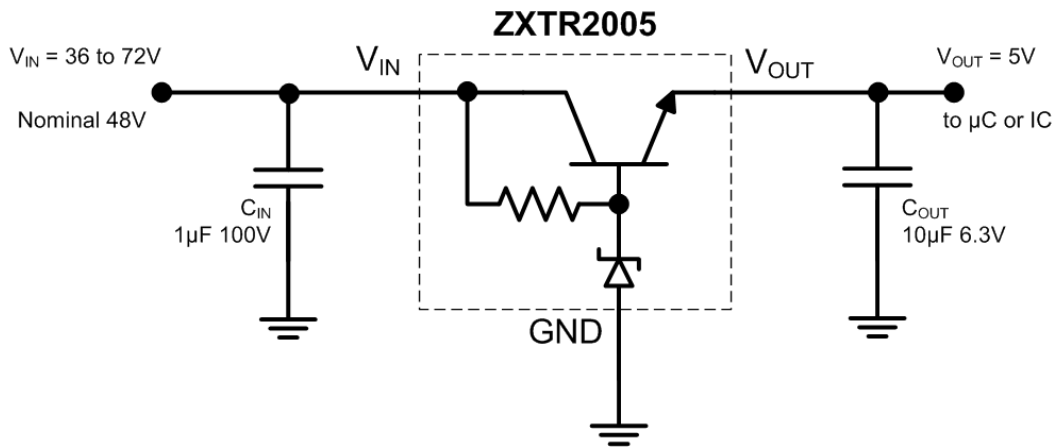

Example of a 5V regulated supply from a nominal 48V for powering a Controller IC.

Pin Functions

Pin Name	Pin Function	Notes
V _{IN}	Input Supply	To maintain output regulation the input voltage can vary from 10V to 100V with respect to the GND pin. It is recommended to connect a 1μF capacitor to GND.
GND	Power Ground	This pin should be tied to the system ground.
V _{OUT}	Voltage Output	Outputs a regulated 5V. It is recommended to connect a 10μF capacitor to GND. Minimum of 10μA must be drawn from V _{OUT} to maintain regulation. The pin can be pulled high to a maximum of 11V with respect to ground.

Typical Electrical Characteristics (@ $T_A = +25^\circ\text{C}$, unless otherwise specified.)

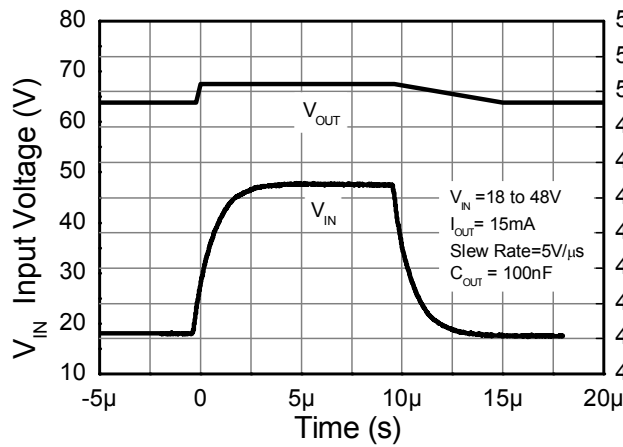

Line transient response

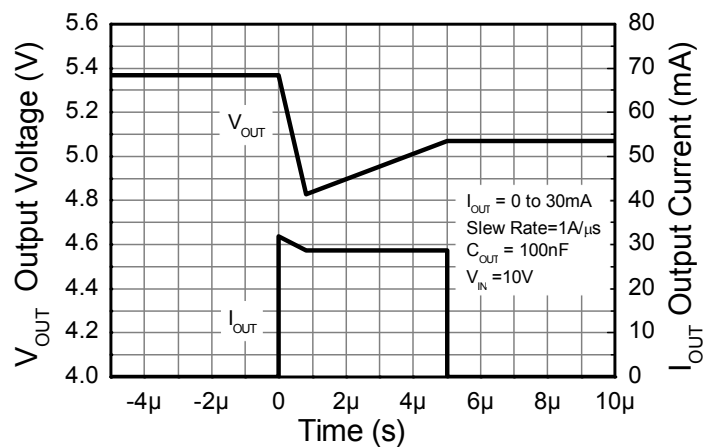

Load transient response

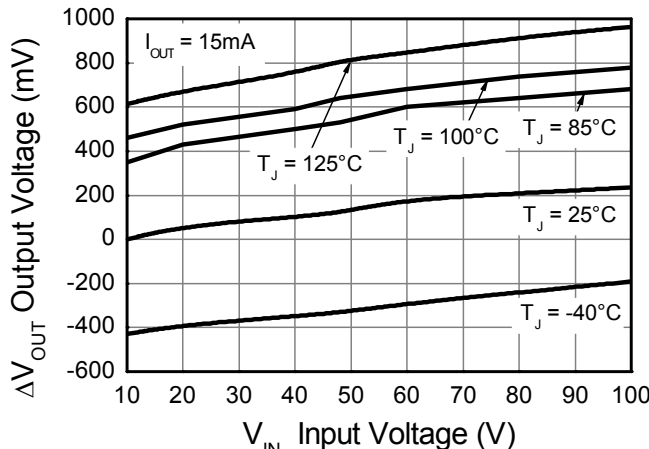

Line Regulation (Note 15)

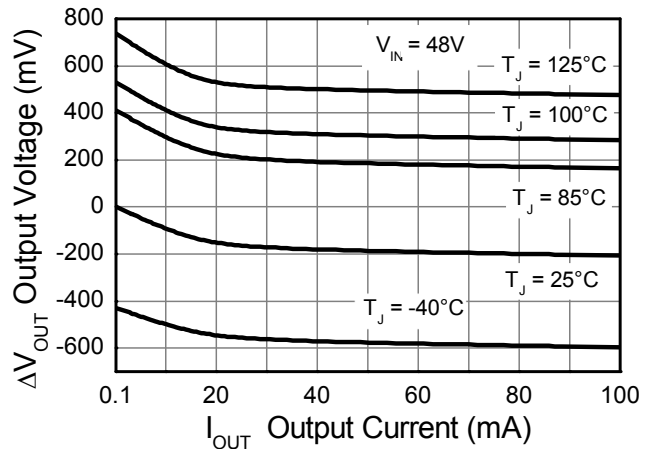

Load Regulation (Note 16)

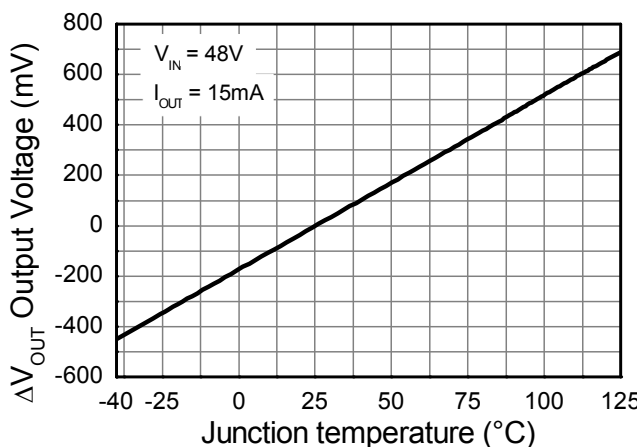

Temperature Coefficient (Note 17)

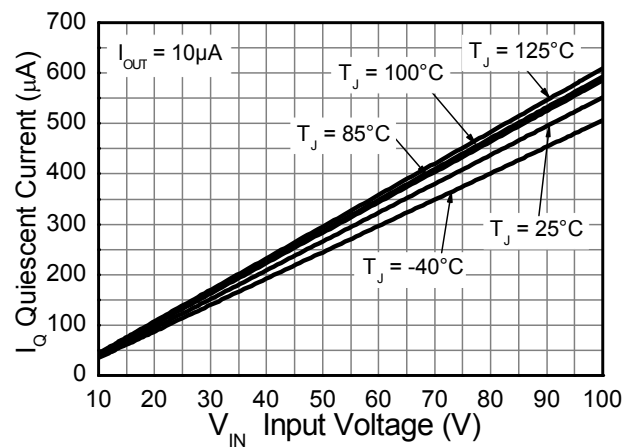

Quiescent Current

Notes: 15. Line regulation $\Delta V_{OUT} = V_{OUT} - V_{OUT}(@ V_{IN} = 15\text{V}, I_{OUT} = 15\text{mA}, T_J = +25^\circ\text{C})$
 16. Load regulation $\Delta V_{OUT} = V_{OUT} - V_{OUT}(@ V_{IN} = 48\text{V}, I_{OUT} = 0.1\text{mA}, T_J = +25^\circ\text{C})$
 17. Temperature Coefficient $\Delta V_{OUT} = V_{OUT} - V_{OUT}(@ V_{IN} = 48\text{V}, I_{OUT} = 15\text{mA}, T_J = +25^\circ\text{C})$

Package Outline Dimensions

Please see AP02002 at <http://www.diodes.com/datasheets/ap02002.pdf> for latest version.

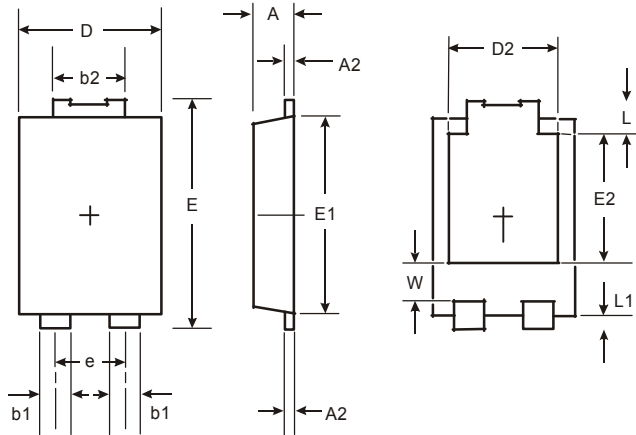

POWERDI [®] 5		
Dim	Min	Max
A	1.05	1.15
A2	0.33	0.43
b1	0.80	0.99
b2	1.70	1.88
D	3.90	4.05
D2	3.054 Typ	
E	6.40	6.60
e	1.84 Typ	
E1	5.30	5.45
E2	3.549 Typ	
L	0.75	0.95
L1	0.50	0.65
W	1.10	1.41
All Dimensions in mm		

Suggested Pad Layout

Please see AP02001 at <http://www.diodes.com/datasheets/ap02001.pdf> for the latest version.

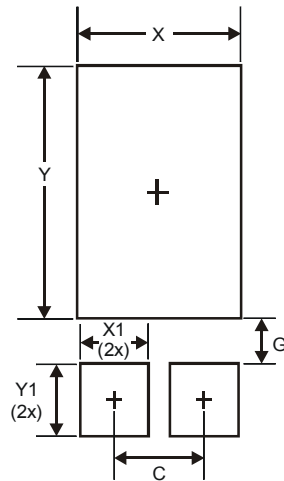

Dimensions	Value (in mm)
C	1.840
G	0.852
X	3.360
X1	1.390
Y	4.860
Y1	1.400

IMPORTANT NOTICE

DIODES INCORPORATED MAKES NO WARRANTY OF ANY KIND, EXPRESS OR IMPLIED, WITH REGARDS TO THIS DOCUMENT, INCLUDING, BUT NOT LIMITED TO, THE IMPLIED WARRANTIES OF MERCHANTABILITY AND FITNESS FOR A PARTICULAR PURPOSE (AND THEIR EQUIVALENTS UNDER THE LAWS OF ANY JURISDICTION).

Diodes Incorporated and its subsidiaries reserve the right to make modifications, enhancements, improvements, corrections or other changes without further notice to this document and any product described herein. Diodes Incorporated does not assume any liability arising out of the application or use of this document or any product described herein; neither does Diodes Incorporated convey any license under its patent or trademark rights, nor the rights of others. Any Customer or user of this document or products described herein in such applications shall assume all risks of such use and will agree to hold Diodes Incorporated and all the companies whose products are represented on Diodes Incorporated website, harmless against all damages.

Diodes Incorporated does not warrant or accept any liability whatsoever in respect of any products purchased through unauthorized sales channel. Should Customers purchase or use Diodes Incorporated products for any unintended or unauthorized application, Customers shall indemnify and hold Diodes Incorporated and its representatives harmless against all claims, damages, expenses, and attorney fees arising out of, directly or indirectly, any claim of personal injury or death associated with such unintended or unauthorized application.

Products described herein may be covered by one or more United States, international or foreign patents pending. Product names and markings noted herein may also be covered by one or more United States, international or foreign trademarks.

This document is written in English but may be translated into multiple languages for reference. Only the English version of this document is the final and determinative format released by Diodes Incorporated.

LIFE SUPPORT

Diodes Incorporated products are specifically not authorized for use as critical components in life support devices or systems without the express written approval of the Chief Executive Officer of Diodes Incorporated. As used herein:

A. Life support devices or systems are devices or systems which:

1. are intended to implant into the body, or
2. support or sustain life and whose failure to perform when properly used in accordance with instructions for use provided in the labeling can be reasonably expected to result in significant injury to the user.

B. A critical component is any component in a life support device or system whose failure to perform can be reasonably expected to cause the failure of the life support device or to affect its safety or effectiveness.

Customers represent that they have all necessary expertise in the safety and regulatory ramifications of their life support devices or systems, and acknowledge and agree that they are solely responsible for all legal, regulatory and safety-related requirements concerning their products and any use of Diodes Incorporated products in such safety-critical, life support devices or systems, notwithstanding any devices- or systems-related information or support that may be provided by Diodes Incorporated. Further, Customers must fully indemnify Diodes Incorporated and its representatives against any damages arising out of the use of Diodes Incorporated products in such safety-critical, life support devices or systems.

Copyright © 2014, Diodes Incorporated

www.diodes.com