

Features

- Bipolar Hall Effect Latch Sensor
- 3.5V to 20V DC Operation Voltage
- Open Collector Pre-Driver
- 50mA Output Sink Current
- Chip Power Reverse-Connection Protection
- Operating Temperature: -40°C~125°C
- SIP3, SC59 and SC59R (Commonly known as SOT23 in Asia): Available in "Green" Molding Compound (No Br, Sb)
- Lead Free Finish/ RoHS Compliant (Note 1)

General Description

AH1751 is a single-digital-output Hall-effect sensor for high temperature operation. The device includes an on-chip Hall voltage generator for magnetic sensing, an amplifier to amplify Hall voltage, and a comparator to provide switching hysteresis for noise rejection, and an open-collector output pre-driver. An internal band-gap regulator is used to provide temperature compensated supply voltage for internal circuits and allows a wide operating supply range.

While the magnetic flux density (B) is larger than threshold Bop, the OUT pin turns on (low). If B removed toward Brp, the OUT pin is latched "on" state prior to B < Brp. When B < Brp, the OUT pin goes into "off" state.

Applications

- Rotor Position Sensing
- Current Switch
- Encoder
- RPM Detection

Ordering Information

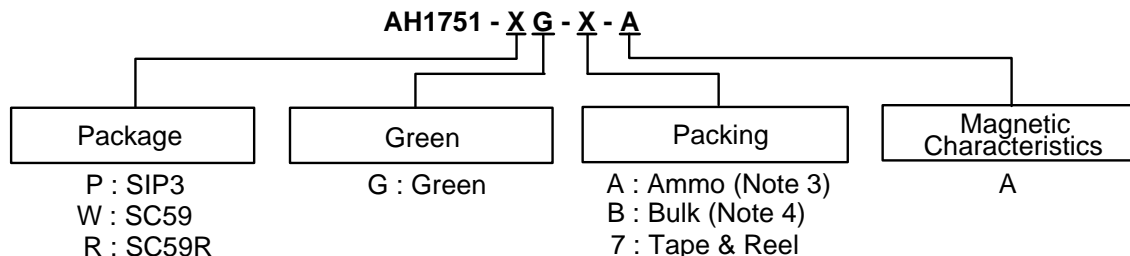

| Device | Package Code | Packaging (Note 2) | Tube/Bulk | | 7" Tape and Reel | | Ammo Box | | Magnetic Characteristics |
|---------------|--------------|--------------------|-----------|--------------------|------------------|--------------------|----------|--------------------|--------------------------|
| | | | Quantity | Part Number Suffix | Quantity | Part Number Suffix | Quantity | Part Number Suffix | |
| AH1751-PG-A-A | P | SIP3 | NA | NA | NA | NA | 4000/Box | -A | A |
| AH1751-PG-B-A | P | SIP3 | 1000 | -B | NA | NA | NA | NA | A |
| AH1751-WG-7-A | W | SC59 | NA | NA | 3000/Tape & Reel | -7 | NA | NA | A |
| AH1751-RG-7-A | R | SC59R | NA | NA | 3000/Tape & Reel | -7 | NA | NA | A |

- Notes:
1. EU Directive 2002/95/EC (RoHS). All applicable RoHS exemptions applied. Please visit our website at http://www.diodes.com/products/lead_free.html
 2. Pad layout as shown on Diodes Inc. suggested pad layout document AP02001, which can be found on our website at <http://www.diodes.com/datasheets/ap02001.pdf>.
 3. Ammo Box is for SIP3 Spread Lead.
 4. Bulk is for SIP3 Straight Lead.

Pin Assignment

(1) SIP3

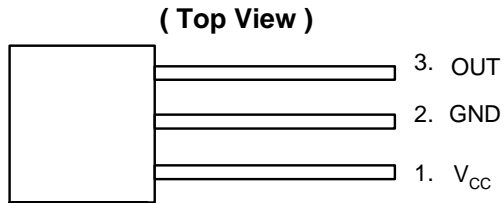

(2) SC59

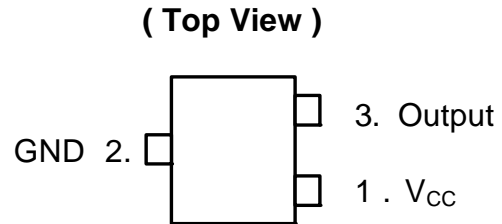

(3) SC59R

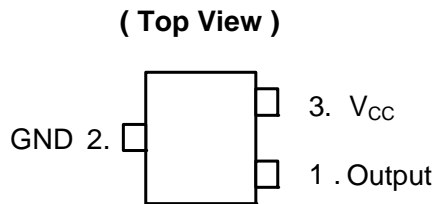

Pin Descriptions

| Pin Name | Description |
|-----------------|--------------|
| V _{CC} | Input Power |
| GND | Ground |
| OUT | Output Stage |

Block Diagram

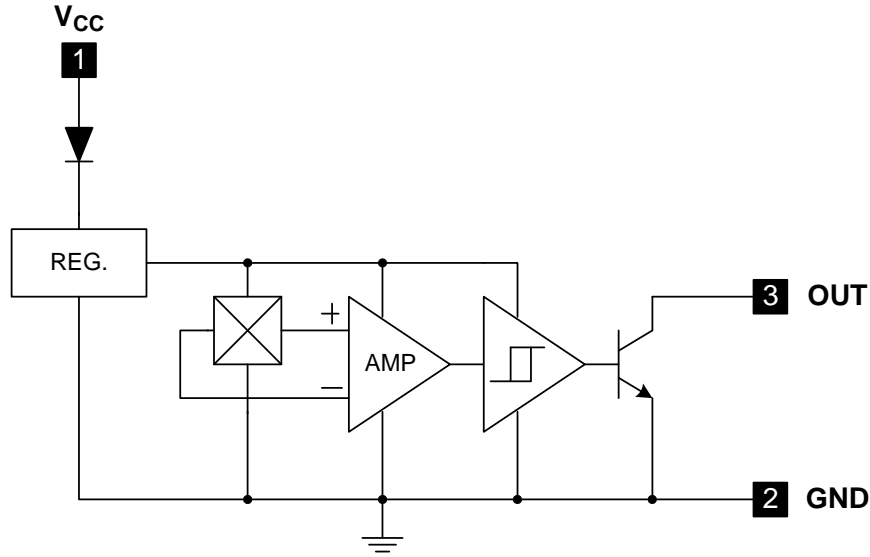

Absolute Maximum Ratings ($T_A = 25^\circ\text{C}$)

| Symbol | Parameter | Rating | Unit | |
|-----------------|------------------------------|----------------|------------------|----|
| V_{CC} | Supply Voltage | 20 | V | |
| $V_{out (off)}$ | Output "OFF" Voltage | 20 | V | |
| $I_o (sink)$ | Output "ON" Current | 100 | mA | |
| T_{ST} | Storage Temperature Range | -65~+150 | $^\circ\text{C}$ | |
| $T_{J(MAX)}$ | Maximum Junction Temperature | +150 | $^\circ\text{C}$ | |
| P_D | Power Dissipation | SIP3 | 550 | mW |
| | | SC59 and SC59R | 230 | mW |

Recommended Operating Conditions

| Symbol | Parameter | Conditions | Min | Max | Unit |
|----------|-----------------------------|--------------------|-----|-----|------------------|
| V_{CC} | Supply Voltage | Operating (Note 5) | 3.5 | 20 | V |
| T_A | Operating Temperature Range | Operating | -40 | 125 | $^\circ\text{C}$ |

Notes: 5. Operating, the output is switching as magnetic field change ($S > 300\text{G}$, $N < -300\text{G}$).

Electrical Characteristics ($T_A = 25^\circ\text{C}$)

| Symbol | Parameter | Conditions | Min | Typ. | Max | Unit |
|----------------|---------------------------|---|-----|------|-----|------|
| $V_{out(SAT)}$ | Output Saturation Voltage | $V_{CC} = 12\text{V}$, OUT "ON" $I_o = 50\text{mA}$ | - | 200 | 300 | mV |
| I_{CC} | Supply Current | $V_{CC} = 12\text{V}$, OUT "OFF" | - | 3.5 | 6 | mA |

Magnetic Characteristics ($T_A = 25^\circ\text{C}$, $V_{CC} = 4\sim 20\text{V}$, Note 6)

A grade (1mT = 10 Gauss)

| Symbol | Parameter | Min | Typ. | Max | Unit |
|--------------------------------|-----------------|-----|------|-----|-------|
| Bops(south pole to brand side) | Operation Point | 5 | - | 70 | Gauss |
| Brps(south pole to brand side) | Release Point | -70 | - | -5 | Gauss |
| Bhy($ B_{opx} - B_{rpx} $) | Hysteresis | - | 75 | - | Gauss |

Notes: 6. Magnetic characteristics are for design information, which will vary with supply voltage, operating temperature and after soldering.

Operating Characteristics

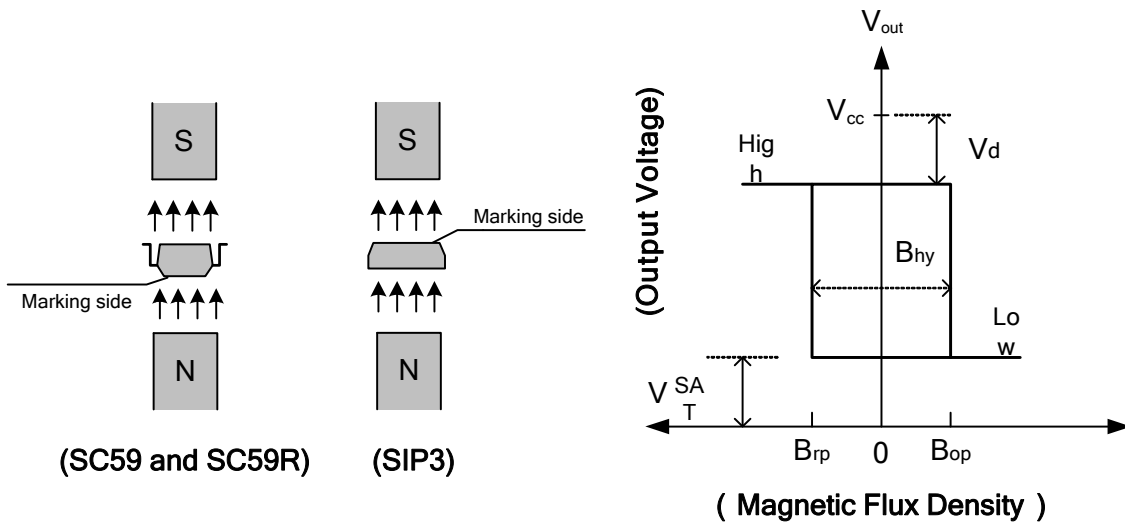

Performance Characteristics

(1) SIP3

| | | | | | | | | | |
|------------|-----|-----|-----|-----|-----|-----|-----|-----|-----|
| T_A (°C) | 25 | 50 | 60 | 70 | 80 | 85 | 90 | 95 | 100 |
| P_D (mW) | 550 | 440 | 396 | 352 | 308 | 286 | 264 | 242 | 220 |
| T_A (°C) | 105 | 110 | 115 | 120 | 125 | 130 | 135 | 140 | 150 |
| P_D (mW) | 198 | 176 | 154 | 132 | 110 | 88 | 66 | 44 | 0 |

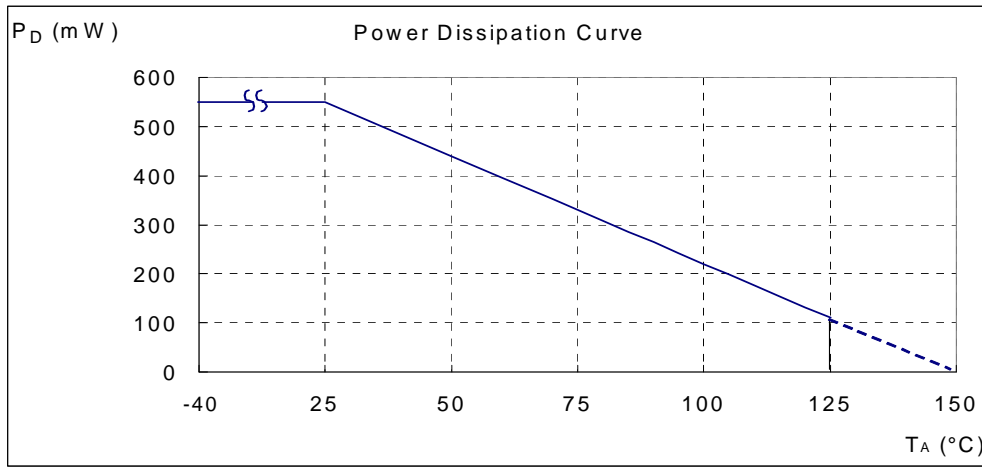

(2) SC59 and SC59R (Commonly known as SOT23 in Asia)

| | | | | | | | | | | | | | |
|------------|-----|-----|-----|-----|-----|-----|-----|-----|-----|-----|-----|-----|-----|
| T_A (°C) | 25 | 50 | 60 | 70 | 80 | 90 | 100 | 110 | 120 | 125 | 130 | 140 | 150 |
| P_D (mW) | 230 | 184 | 166 | 147 | 129 | 110 | 92 | 74 | 55 | 46 | 37 | 18 | 0 |

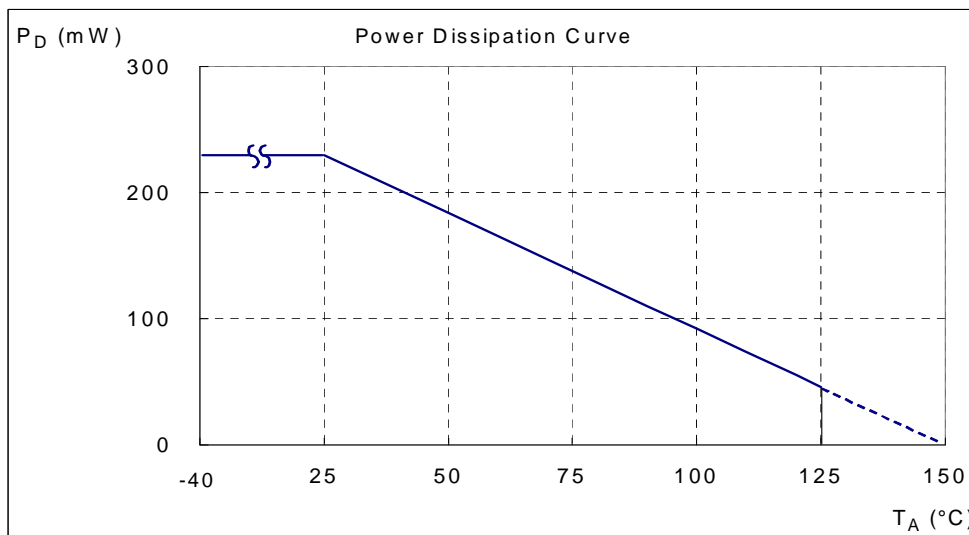

Marking Information

(1) SIP3

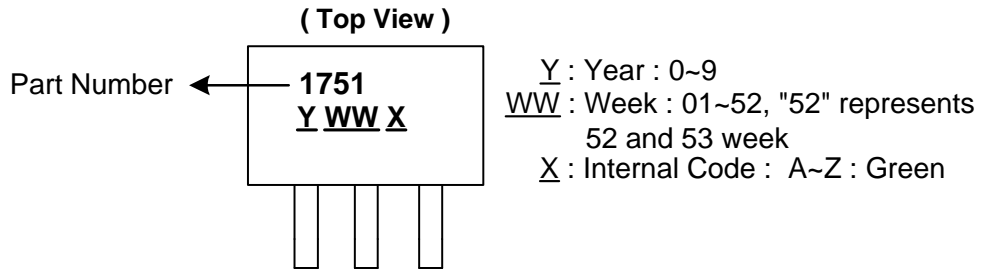

(2) SC59 and SC59R (Commonly known as SOT23 in Asia)

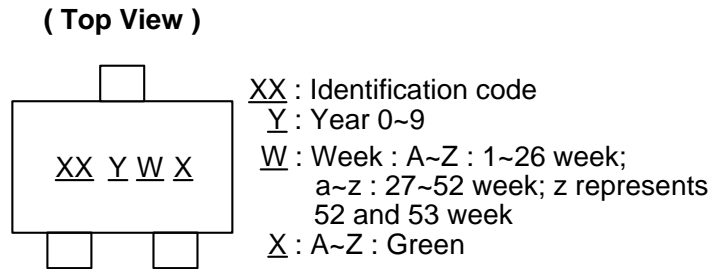

| Part Number | Package | Identification Code |
|-------------|---------|---------------------|
| AH1751 | SC59 | RK |
| AH1751 | SC59R | SK |

Package Information (All Dimensions in mm)

(1) Package Type: SIP3 for Bulk pack

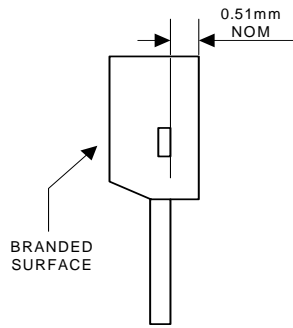

Active Area Depth

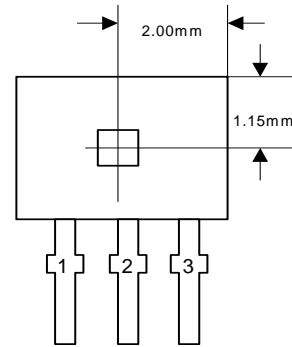

Sensor Location

Package Dimension

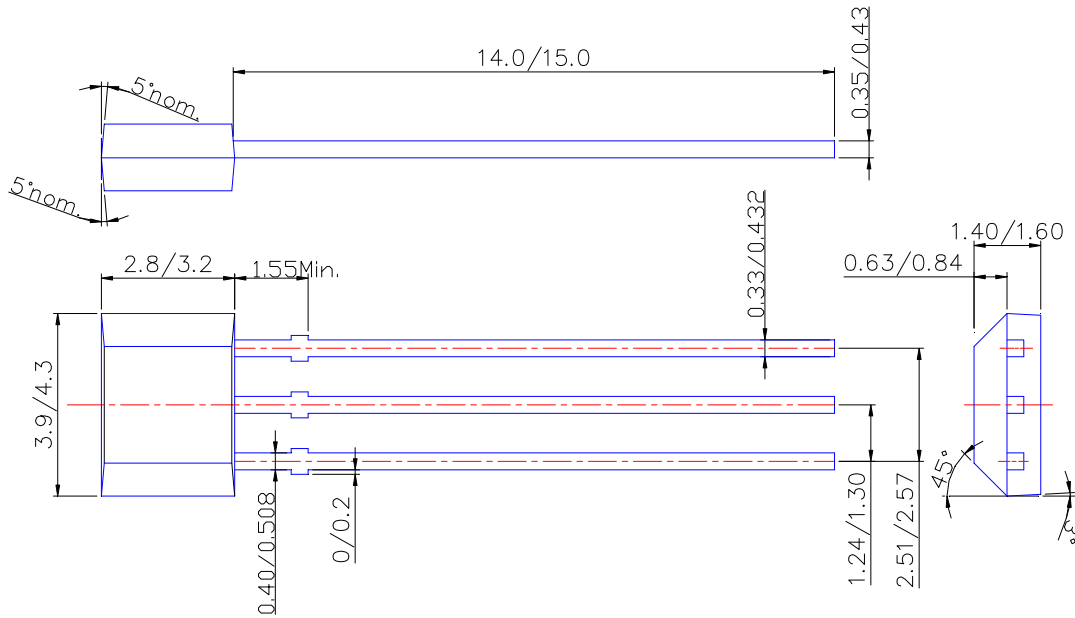

Package Information (Continued)

(2) Package Type: SIP3 for Ammo pack

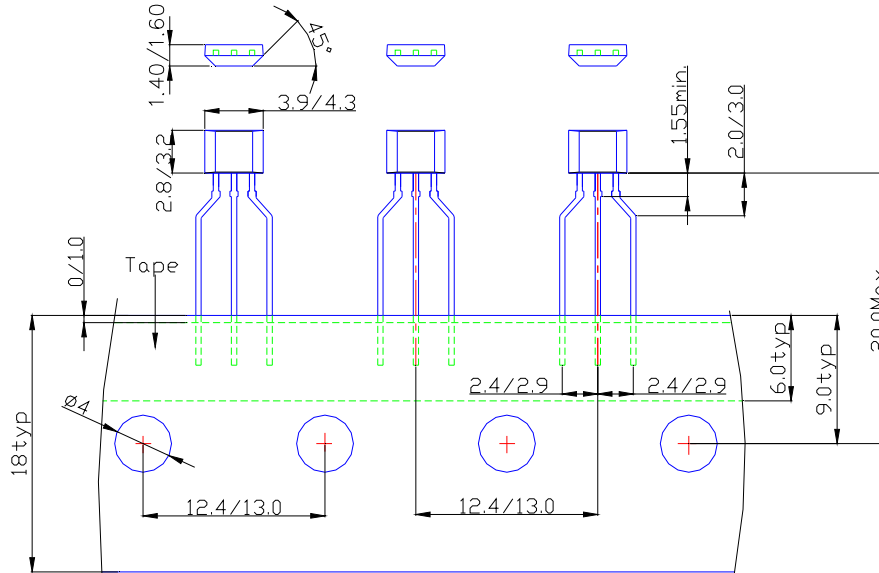

(3) Package Type: SC59 and SC59R (Commonly known as SOT23 in Asia)

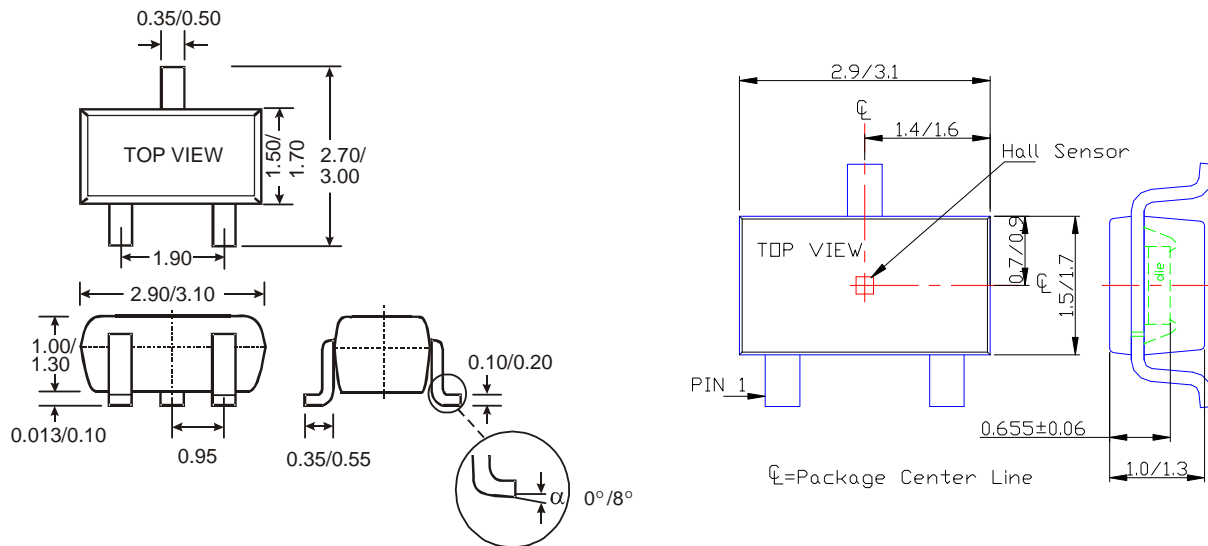

IMPORTANT NOTICE

DIODES INCORPORATED MAKES NO WARRANTY OF ANY KIND, EXPRESS OR IMPLIED, WITH REGARDS TO THIS DOCUMENT, INCLUDING, BUT NOT LIMITED TO, THE IMPLIED WARRANTIES OF MERCHANTABILITY AND FITNESS FOR A PARTICULAR PURPOSE (AND THEIR EQUIVALENTS UNDER THE LAWS OF ANY JURISDICTION).

Diodes Incorporated and its subsidiaries reserve the right to make modifications, enhancements, improvements, corrections or other changes without further notice to this document and any product described herein. Diodes Incorporated does not assume any liability arising out of the application or use of this document or any product described herein; neither does Diodes Incorporated convey any license under its patent or trademark rights, nor the rights of others. Any Customer or user of this document or products described herein in such applications shall assume all risks of such use and will agree to hold Diodes Incorporated and all the companies whose products are represented on Diodes Incorporated website, harmless against all damages.

Diodes Incorporated does not warrant or accept any liability whatsoever in respect of any products purchased through unauthorized sales channel.

Should Customers purchase or use Diodes Incorporated products for any unintended or unauthorized application, Customers shall indemnify and hold Diodes Incorporated and its representatives harmless against all claims, damages, expenses, and attorney fees arising out of, directly or indirectly, any claim of personal injury or death associated with such unintended or unauthorized application.

Products described herein may be covered by one or more United States, international or foreign patents pending. Product names and markings noted herein may also be covered by one or more United States, international or foreign trademarks.

LIFE SUPPORT

Diodes Incorporated products are specifically not authorized for use as critical components in life support devices or systems without the express written approval of the Chief Executive Officer of Diodes Incorporated. As used herein:

A. Life support devices or systems are devices or systems which:

1. are intended to implant into the body, or
2. support or sustain life and whose failure to perform when properly used in accordance with instructions for use provided in the labeling can be reasonably expected to result in significant injury to the user.

B. A critical component is any component in a life support device or system whose failure to perform can be reasonably expected to cause the failure of the life support device or to affect its safety or effectiveness.

Customers represent that they have all necessary expertise in the safety and regulatory ramifications of their life support devices or systems, and acknowledge and agree that they are solely responsible for all legal, regulatory and safety-related requirements concerning their products and any use of Diodes Incorporated products in such safety-critical, life support devices or systems, notwithstanding any devices- or systems-related information or support that may be provided by Diodes Incorporated. Further, Customers must fully indemnify Diodes Incorporated and its representatives against any damages arising out of the use of Diodes Incorporated products in such safety-critical, life support devices or systems.

Copyright © 2009, Diodes Incorporated

www.diodes.com