

TVS Diodes

Transient Voltage Suppressor Diodes

ESD3V3U4ULC

Ultra-low Capacitance ESD / Transient Protection Array

ESD3V3U4ULC

Data Sheet

Rev. 1.6, 2013-02-20
Final

Edition 2013-02-20

**Published by
Infineon Technologies AG
81726 Munich, Germany**

**© 2013 Infineon Technologies AG
All Rights Reserved.**

Legal Disclaimer

The information given in this document shall in no event be regarded as a guarantee of conditions or characteristics. With respect to any examples or hints given herein, any typical values stated herein and/or any information regarding the application of the device, Infineon Technologies hereby disclaims any and all warranties and liabilities of any kind, including without limitation, warranties of non-infringement of intellectual property rights of any third party.

Information

For further information on technology, delivery terms and conditions and prices, please contact the nearest Infineon Technologies Office (www.infineon.com).

Warnings

Due to technical requirements, components may contain dangerous substances. For information on the types in question, please contact the nearest Infineon Technologies Office.

Infineon Technologies components may be used in life-support devices or systems only with the express written approval of Infineon Technologies, if a failure of such components can reasonably be expected to cause the failure of that life-support device or system or to affect the safety or effectiveness of that device or system. Life support devices or systems are intended to be implanted in the human body or to support and/or maintain and sustain and/or protect human life. If they fail, it is reasonable to assume that the health of the user or other persons may be endangered.

Revision History Revision 1.5, 2012-12-05

Page or Item	Subjects (major changes since previous revision)
--------------	--

Rev. 1.6, 2013-02-20

6	Small updateds in Table 3

Trademarks of Infineon Technologies AG

AURIX™, BlueMoon™, COMNEON™, C166™, CROSSAVE™, CanPAK™, CIPOS™, CoolMOS™, CoolSET™, CORECONTROL™, DAVE™, EasyPIM™, EconoBRIDGE™, EconoDUAL™, EconoPACK™, EconoPIM™, EiceDRIVER™, EUPEC™, FCOS™, HITFET™, HybridPACK™, ISOFACE™, I²RF™, IsoPACK™, MIPAQ™, ModSTACK™, my-d™, NovalithIC™, OmniTune™, OptiMOS™, ORIGA™, PROFET™, PRO-SIL™, PRIMARION™, PrimePACK™, RASIC™, ReverSave™, SatRIC™, SIEGET™, SINDRION™, SMARTi™, SmartLEWIS™, TEMPFET™, thinQ!™, TriCore™, TRENCHSTOP™, X-GOLD™, XMM™, X-PMU™, XPOSYS™.

Other Trademarks

Advance Design System™ (ADS) of Agilent Technologies, AMBA™, ARM™, MULTI-ICE™, PRIMECELL™, REALVIEW™, THUMB™ of ARM Limited, UK. AUTOSAR™ is licensed by AUTOSAR development partnership. Bluetooth™ of Bluetooth SIG Inc. CAT-iq™ of DECT Forum. COLOSSUS™, FirstGPS™ of Trimble Navigation Ltd. EMV™ of EMVCo, LLC (Visa Holdings Inc.). EPCOS™ of Epcos AG. FLEXGO™ of Microsoft Corporation. FlexRay™ is licensed by FlexRay Consortium. HYPERTERMINAL™ of Hilgraeve Incorporated. IEC™ of Commission Electrotechnique Internationale. IrDA™ of Infrared Data Association Corporation. ISO™ of INTERNATIONAL ORGANIZATION FOR STANDARDIZATION. MATLAB™ of MathWorks, Inc. MAXIM™ of Maxim Integrated Products, Inc. MICROTEC™, NUCLEUS™ of Mentor Graphics Corporation. Mifare™ of NXP. MIPI™ of MIPI Alliance, Inc. MIPS™ of MIPS Technologies, Inc., USA. muRata™ of MURATA MANUFACTURING CO., MICROWAVE OFFICE™ (MWO) of Applied Wave Research Inc., OmniVision™ of OmniVision Technologies, Inc. Openwave™ Openwave Systems Inc. RED HAT™ Red Hat, Inc. RFMD™ RF Micro Devices, Inc. SIRIUS™ of Sirius Sattelite Radio Inc. SOLARIS™ of Sun Microsystems, Inc. SPANSION™ of Spansion LLC Ltd. Symbian™ of Symbian Software Limited. TAIYO YUDEN™ of Taiyo Yuden Co. TEAKLITE™ of CEVA, Inc. TEKTRONIX™ of Tektronix Inc. TOKO™ of TOKO KABUSHIKI KAISHA TA. UNIX™ of X/Open Company Limited. VERILOG™, PALLADIUM™ of Cadence Design Systems, Inc. VLYNQ™ of Texas Instruments Incorporated. VXWORKS™, WIND RIVER™ of WIND RIVER SYSTEMS, INC. ZETEX™ of Diodes Zetex Limited.

Last Trademarks Update 2010-06-09

1 Ultra-low Capacitance ESD / Transient Protection Array

1.1 Features

- ESD / transient protection of high speed data lines exceeding:
 - IEC61000-4-2 (ESD): ± 20 kV (air/contact)
 - IEC61000-4-4 (EFT): ± 2.5 kV (5/50ns)
 - IEC61000-4-5 (Surge): ± 3 A (8/20 μ s)
- Maximum working voltage: $V_{RWM} = 3.3$ V
- Ultra low capacitance $C_L = 0.4$ pF I/O to GND (typical)
- Very low clamping voltage: $V_{CL} = 8$ V (typical) at $I_{PP} = 16$ A
- Very low dynamic resistance: $R_{DYN} = 0.19$ Ω (typical)
- TSLP-9-1 package with pad pitch 0.5 mm, optimized pad design to simplify PCB layout
- Pb-free and halogen free package (RoHS compliant)



1.2 Application Examples

- USB 3.0, 10/100/1000 Ethernet, Firewire
- DVI, HDMI, S-ATA, DisplayPort
- Mobile HDMI Link, MDDI, MIPI, etc.

1.3 Product Description

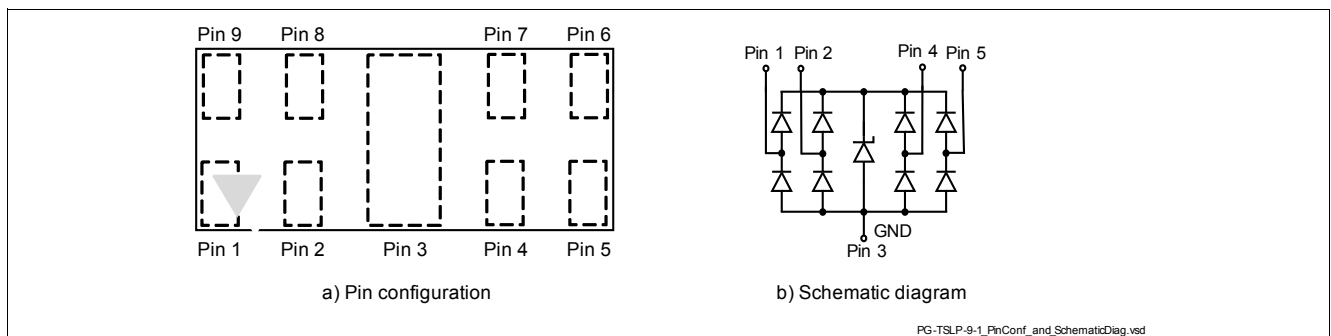

Figure 1 Pin Configuration and Schematic Diagram

Table 1 Ordering Information

Type	Package	Configuration	Marking code
ESD3V3U4ULC	TSLP-9-1	4 lines, uni-directional	Z2

2 Characteristics

Table 2 Maximum Rating at $T_A = 25\text{ }^\circ\text{C}$, unless otherwise specified

Parameter	Symbol	Values			Unit
		Min.	Typ.	Max.	
ESD contact discharge ¹⁾	V_{ESD}	-20	–	20	kV
Peak pulse current ($t_p = 8/20\text{ }\mu\text{s}$) ²⁾	I_{PP}	-3	–	3	A
Operating temperature	T_{OP}	-40	–	125	$^\circ\text{C}$
Storage temperature	T_{stg}	-65	–	150	$^\circ\text{C}$

1) V_{ESD} according to IEC61000-4-2

2) I_{PP} according to IEC61000-4-5

2.1 Electrical Characteristics at $T_A = 25\text{ }^\circ\text{C}$, unless otherwise specified

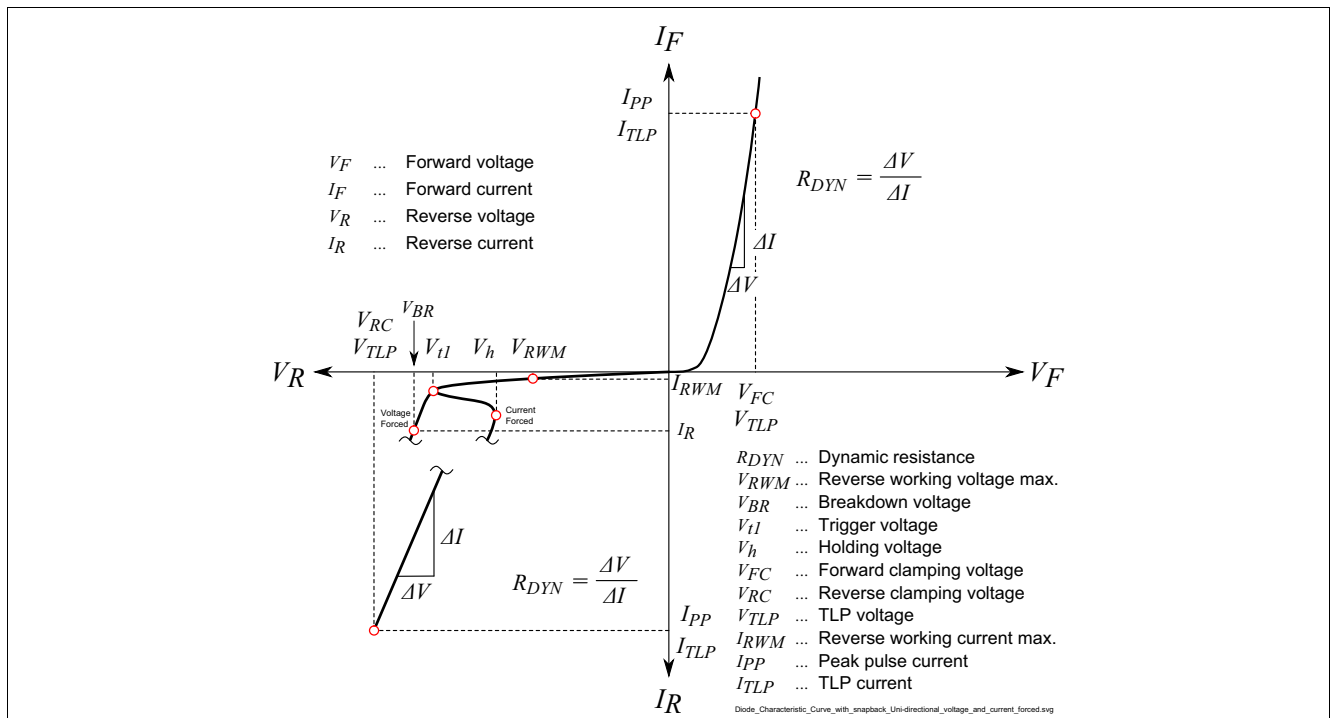

Figure 2 Definitions of electrical characteristics[1]

Table 3 DC Characteristics at $T_A = 25\text{ °C}$, unless otherwise specified

Parameter	Symbol	Values			Unit	Note / Test Condition
		Min.	Typ.	Max.		
Reverse working voltage ¹⁾	V_{RWM}	–	–	3.3	V	I/O to GND
Reverse current ¹⁾	I_R	–	1	50	nA	I/O to GND, $V_R = 3.3\text{ V}$
Breakdown voltage ¹⁾	V_{BR}	–	6.2	–	V	I/O to GND,
Reverse trigger voltage ²⁾	V_{t1}	–	6.2	–	V	I/O to GND,
Reverse holding voltage ²⁾	V_h	3.35	4	4.4	V	I/O to GND, $I_R = 10\text{ mA}$

1) Voltage forced

2) Current forced

Table 4 RF Characteristics at $T_A = 25\text{ °C}$, unless otherwise specified

Parameter	Symbol	Values			Unit	Note / Test Condition
		Min.	Typ.	Max.		
Line capacitance ¹⁾	C_L	–	0.4	0.65	pF	$V_R = 0\text{ V}, f = 1\text{ MHz}$, I/O to GND
		–	0.2	0.35	pF	$V_R = 0\text{ V}, f = 1\text{ MHz}$, I/O to I/O
Channel capacitance matching between I/O to GND	$\Delta C_{i/o-GND}$	–	0.035	–	pF	$V_R = 0\text{ V}, f = 1\text{ MHz}$, I/O to GND
Channel capacitance matching between I/O to I/O	$\Delta C_{i/o-i/o}$	–	0.017	–	pF	$V_R = 0\text{ V}, f = 1\text{ MHz}$, I/O to I/O

1) Total capacitance line to ground

Table 5 ESD Characteristics at $T_A = 25\text{ °C}$, unless otherwise specified

Parameter	Symbol	Values			Unit	Note / Test Condition
		Min.	Typ.	Max.		
Clamping volage ¹⁾	V_{CL}	–	4.8	–	V	$I_{PP} = 1\text{ A}$, $t_p = 8/20\mu\text{s}$ from I/O to GND
		–	6.2	–		$I_{PP} = 3\text{ A}$, $t_p = 8/20\mu\text{s}$ from I/O to GND
Clamping voltage ²⁾	V_{CL}	–	8	–		$I_{TLP} = 16\text{ A}$, from I/O to GND
		–	11	–		$I_{TLP} = 30\text{ A}$, from I/O to GND
Forward clamping voltage ¹⁾	V_{FC}	–	1.4	–		$I_{PP} = 1\text{ A}$, $t_p = 8/20\mu\text{s}$ from GND to I/O
		–	2.3	–		$I_{PP} = 3\text{ A}$, $t_p = 8/20\mu\text{s}$ from GND to I/O
Forward clamping voltage ²⁾	V_{FC}	–	6	–		$I_{TLP} = 16\text{ A}$, from GND to I/O
		–	9	–		$I_{TLP} = 30\text{ A}$, from GND to I/O
Dynamic resistance ²⁾	R_{DYN}	–	0.19	–	Ω	I/O to GND
		–	0.23	–	Ω	GND to any I/O

1) I_{PP} according to IEC61000-4-5

2) Please refer to Application Note AN210. TLP parameter: $Z_0 = 50\ \Omega$, $t_p = 100\text{ ns}$, $t_r = 300\text{ ps}$, averaging window: $t_1 = 30\text{ ns}$ to $t_2 = 60\text{ ns}$, extraction of dynamic resistance using least squares fit of TLP characteristic between $I_{PP1} = 10\text{ A}$ and $I_{PP2} = 40\text{ A}$ [2].

Typical Characteristics at $T_A = 25\text{ }^\circ\text{C}$, unless otherwise specified

3 Typical Characteristics at $T_A = 25\text{ }^\circ\text{C}$, unless otherwise specified

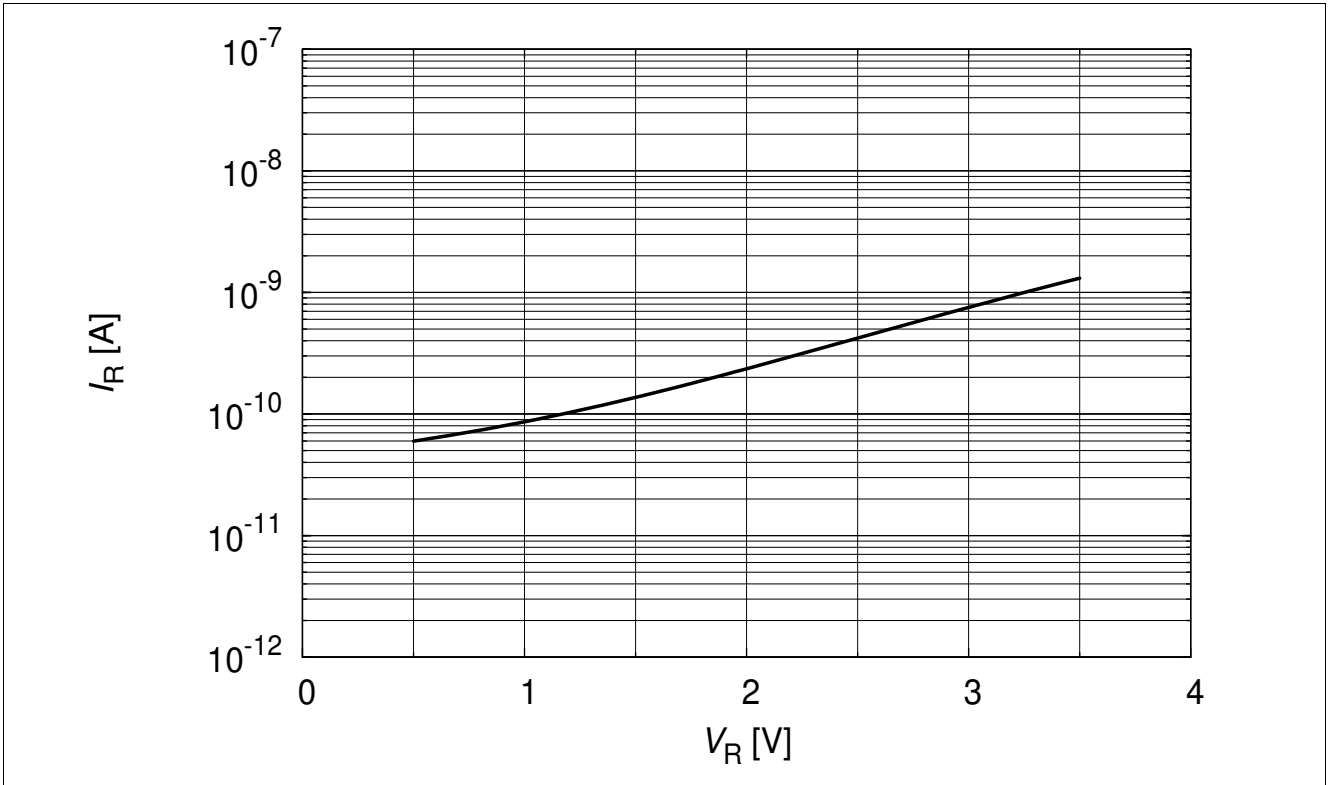

Figure 3 Reverse current, $I_R = (V_R)$

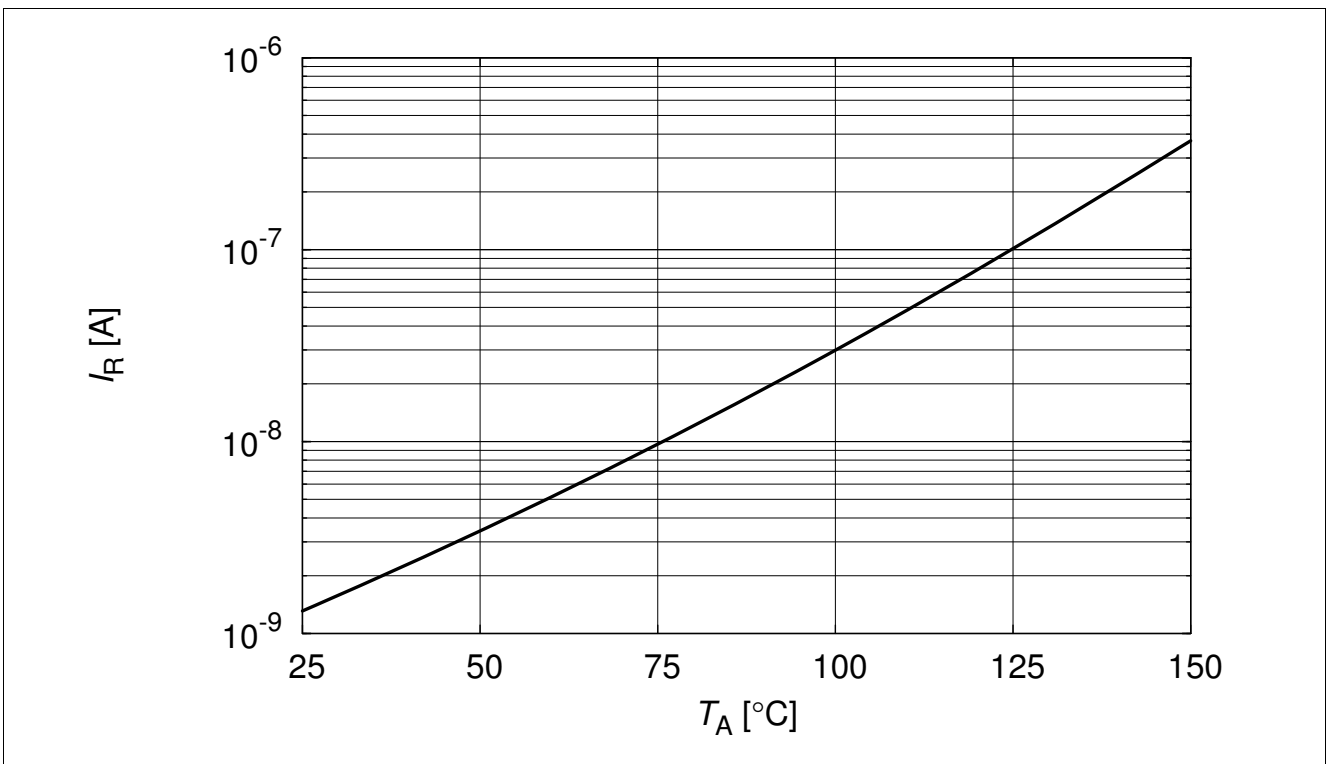

Figure 4 Reverse current: $I_R = f(T_A)$, $V_R = 3.3\text{ V}$

Typical Characteristics at $T_A = 25\text{ }^\circ\text{C}$, unless otherwise specified

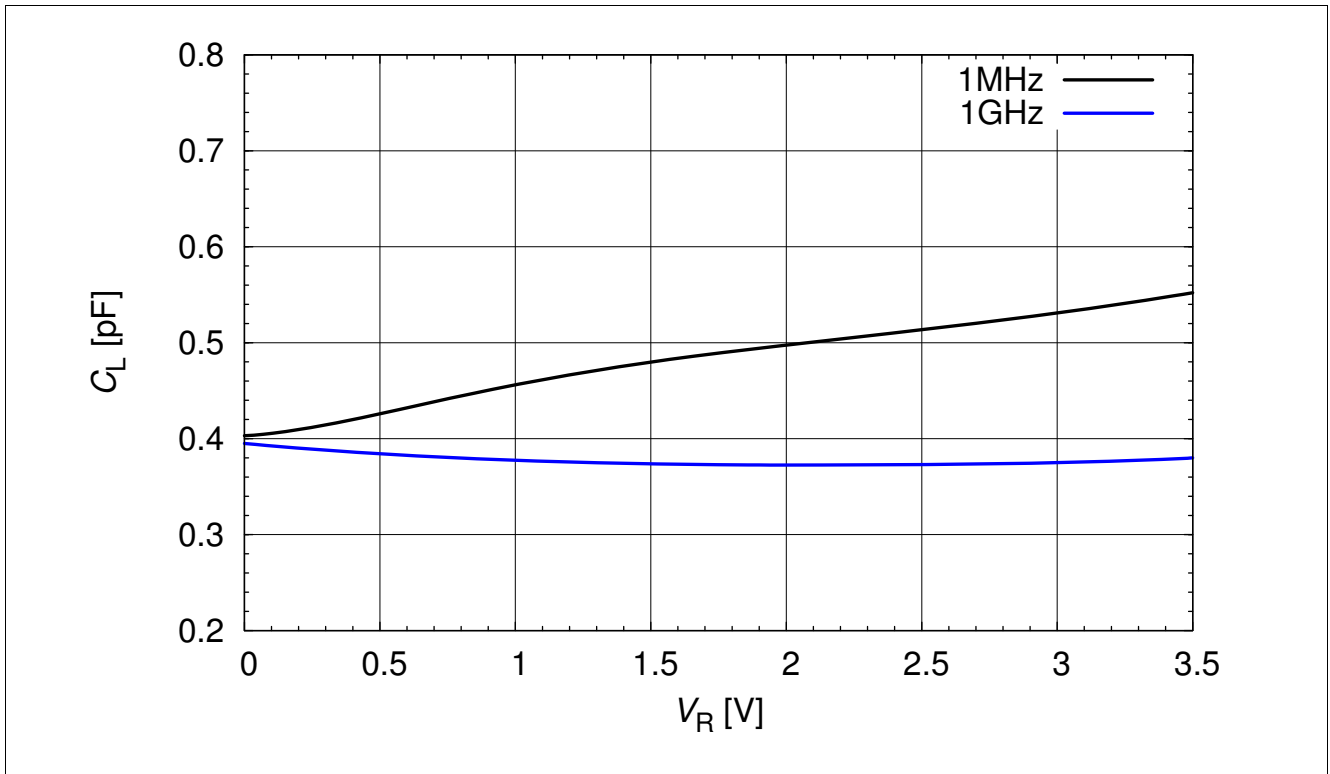

Figure 5 Line capacitance: $C_L = f(V_R)$, $f = 1\text{MHz}$, from I/O to GND

Typical Characteristics at $T_A = 25\text{ }^\circ\text{C}$, unless otherwise specified

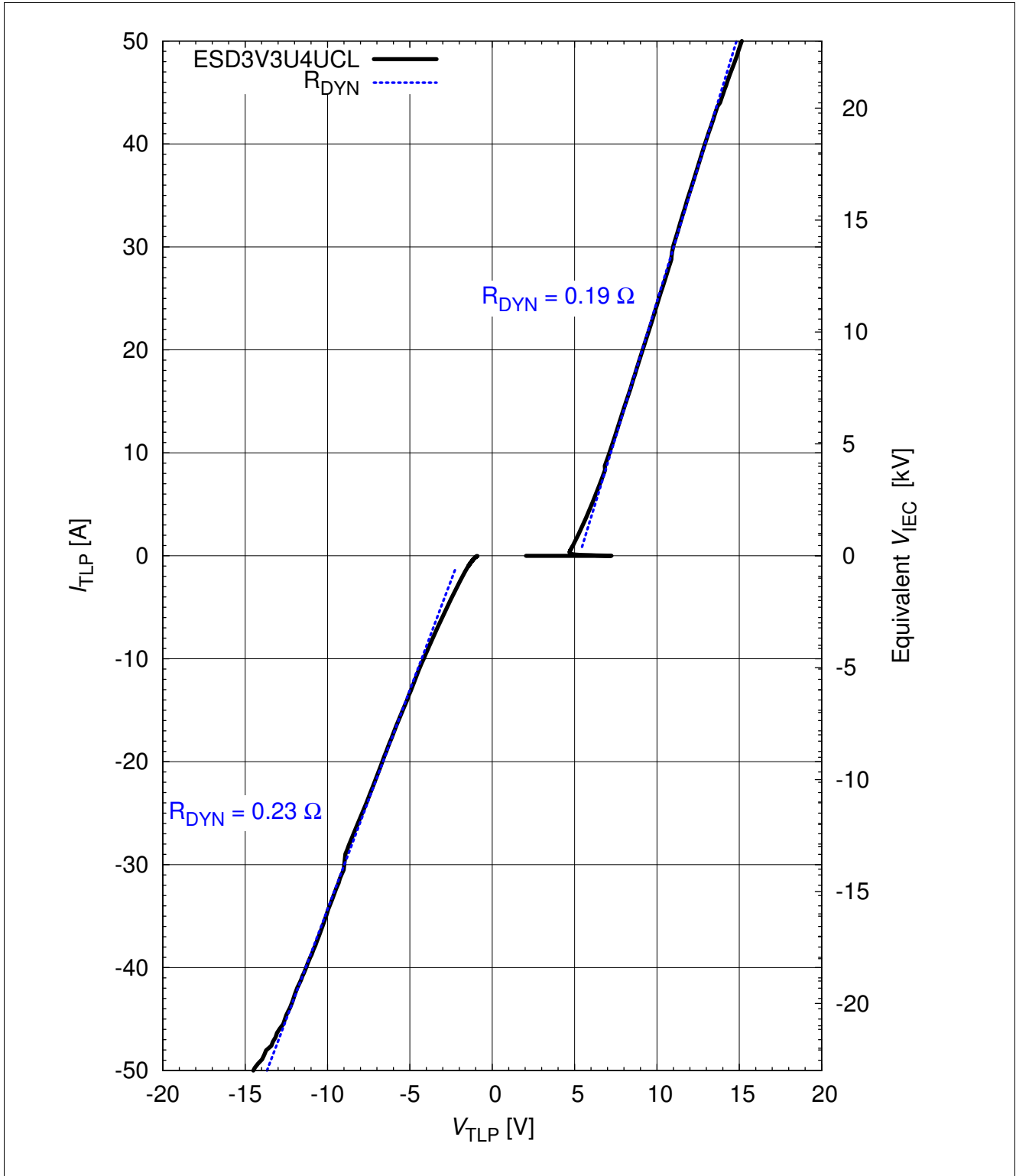

Figure 6 Clamping voltage (TLP): $I_{TLP} = f(V_{TLP})$ according ANSI/ESD STM5.5.1- Electrostatic Discharge Sensitivity Testing using Transmission Line Pulse (TLP) Model. TLP conditions: $Z_0 = 50\ \Omega$, $t_p = 100\text{ ns}$, $t_r = 0.6\text{ ns}$, I_{TLP} and V_{TLP} averaging window: $t_1 = 30\text{ ns}$ to $t_2 = 60\text{ ns}$, extraction of dynamic resistance using squares fit to TLP characteristics between $I_{TLP1} = 10\text{ A}$ and $I_{TLP2} = 40\text{ A}$. Please refer to Application Note AN210[2]

Typical Characteristics at $T_A = 25\text{ }^\circ\text{C}$, unless otherwise specified

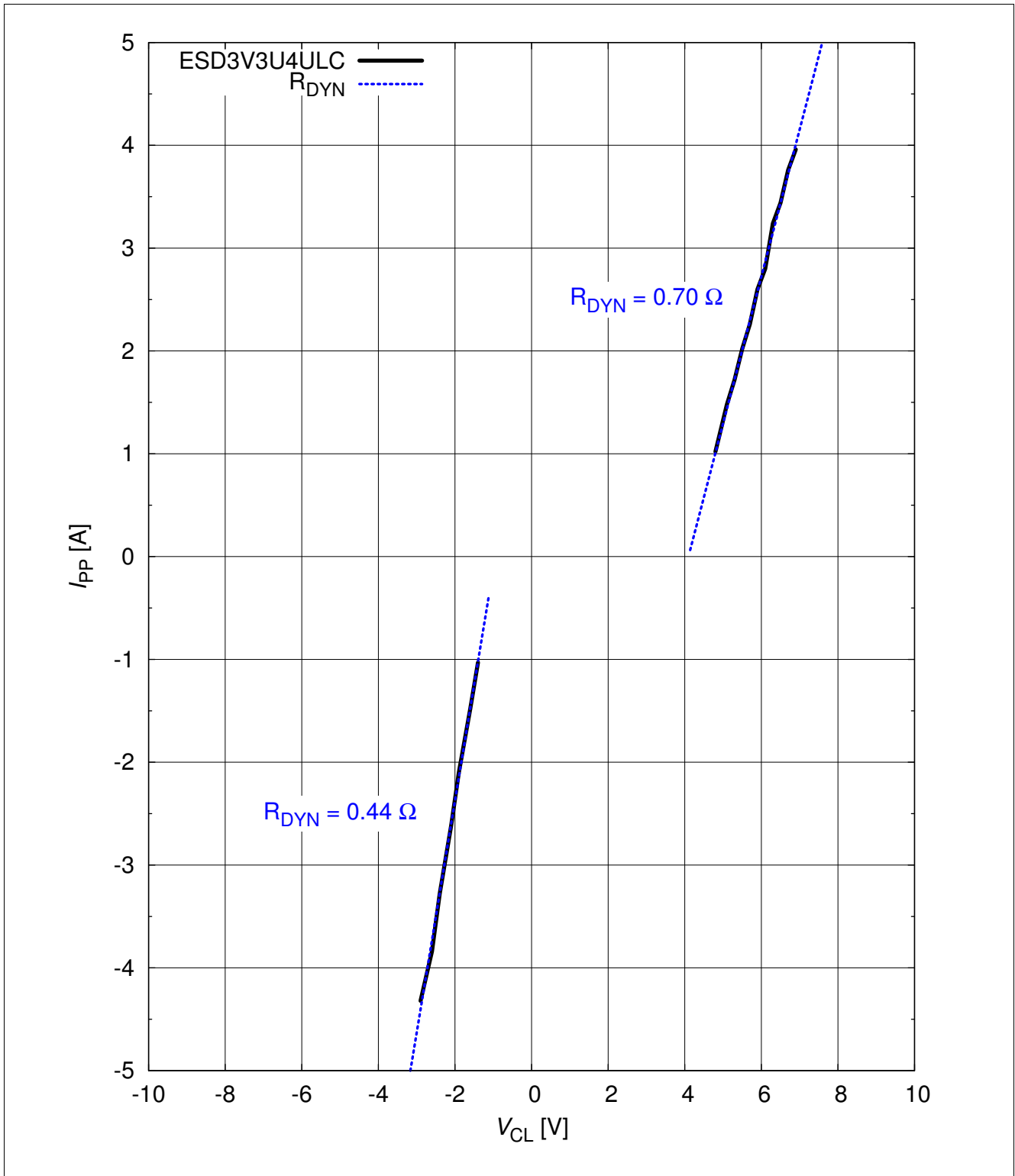

Figure 7 Pulse current (IEC61000-4-5) versus clamping voltage: $I_{PP} = f(V_{CL})$

Typical Characteristics at $T_A = 25\text{ }^\circ\text{C}$, unless otherwise specified

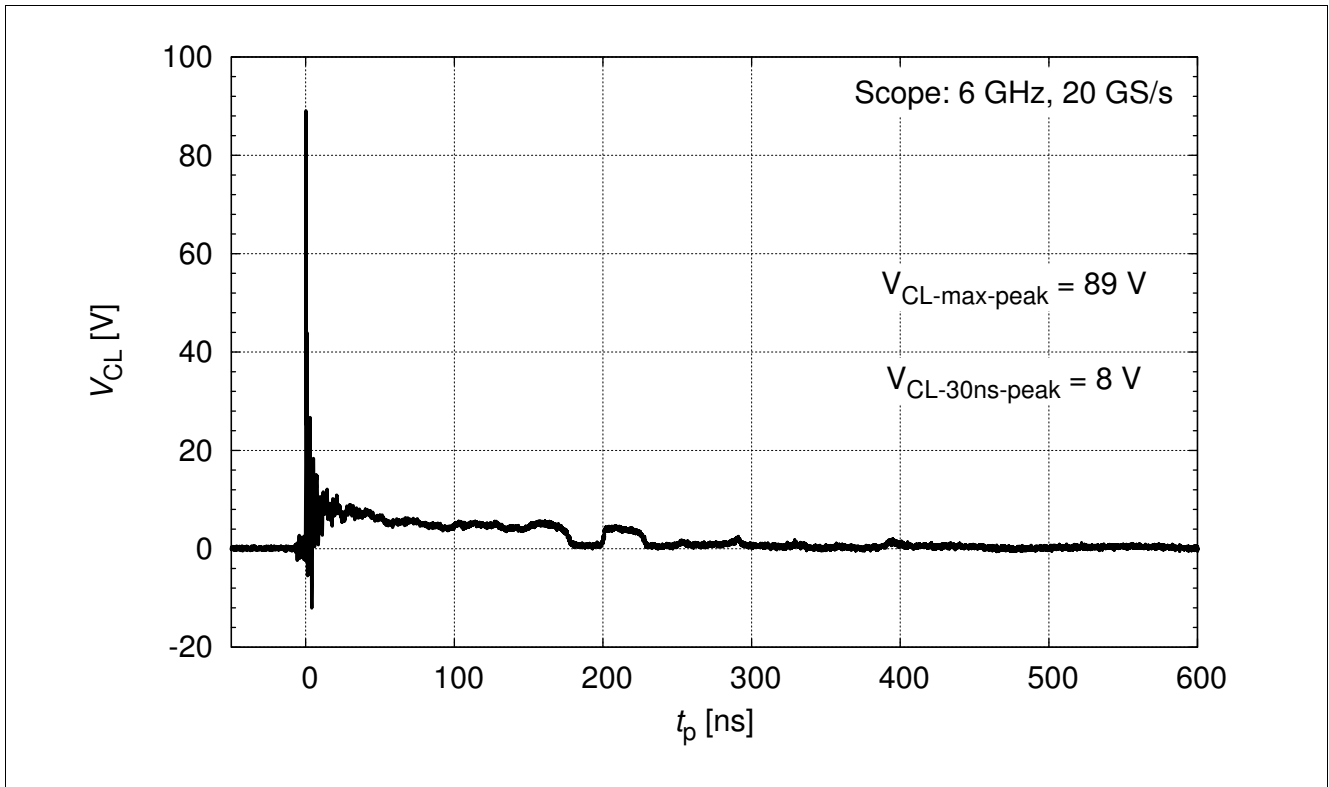

Figure 8 Clamping voltage at +8 kV discharge according IEC61000-4-2 ($R = 330\ \Omega$, $C = 150\ \text{pF}$)

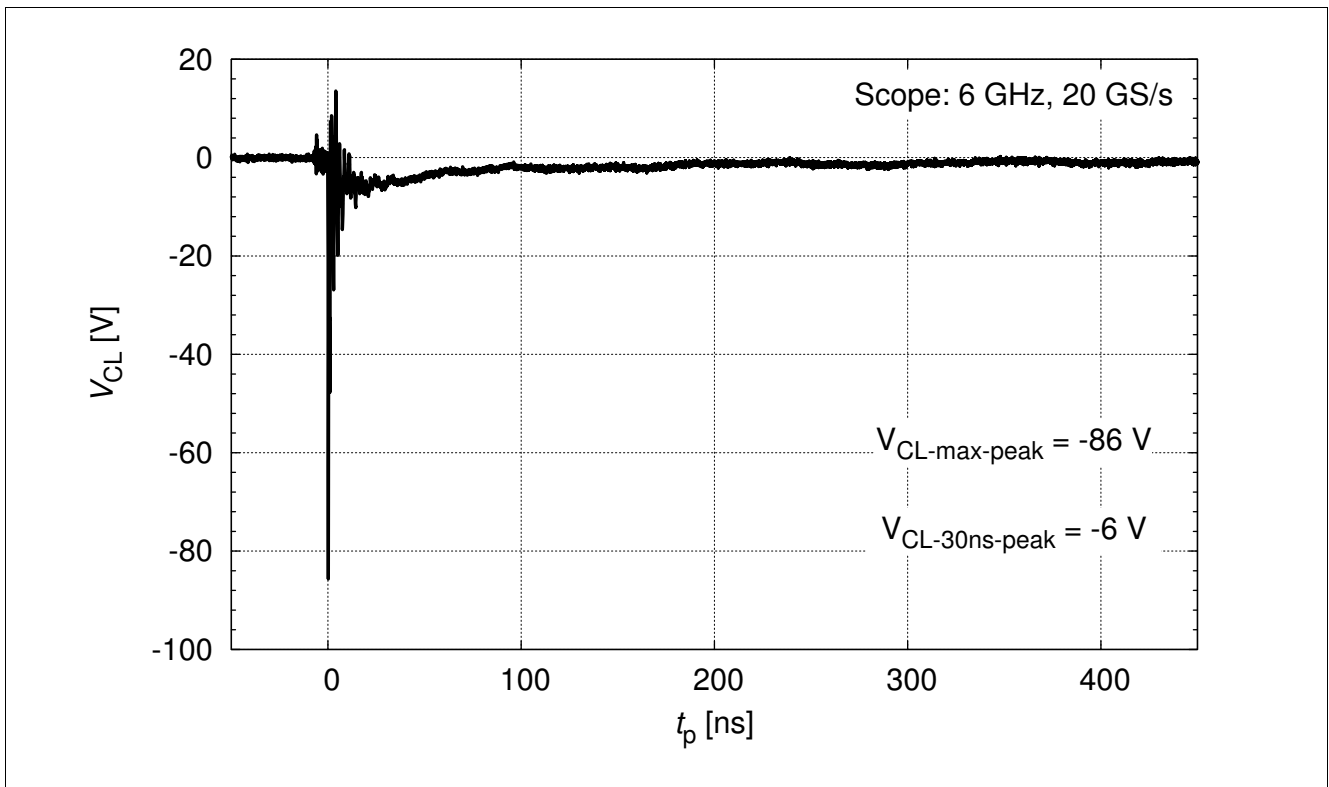

Figure 9 Clamping voltage at -8 kV discharge according IEC61000-4-2 ($R = 330\ \Omega$, $C = 150\ \text{pF}$)

Typical Characteristics at $T_A = 25\text{ }^\circ\text{C}$, unless otherwise specified

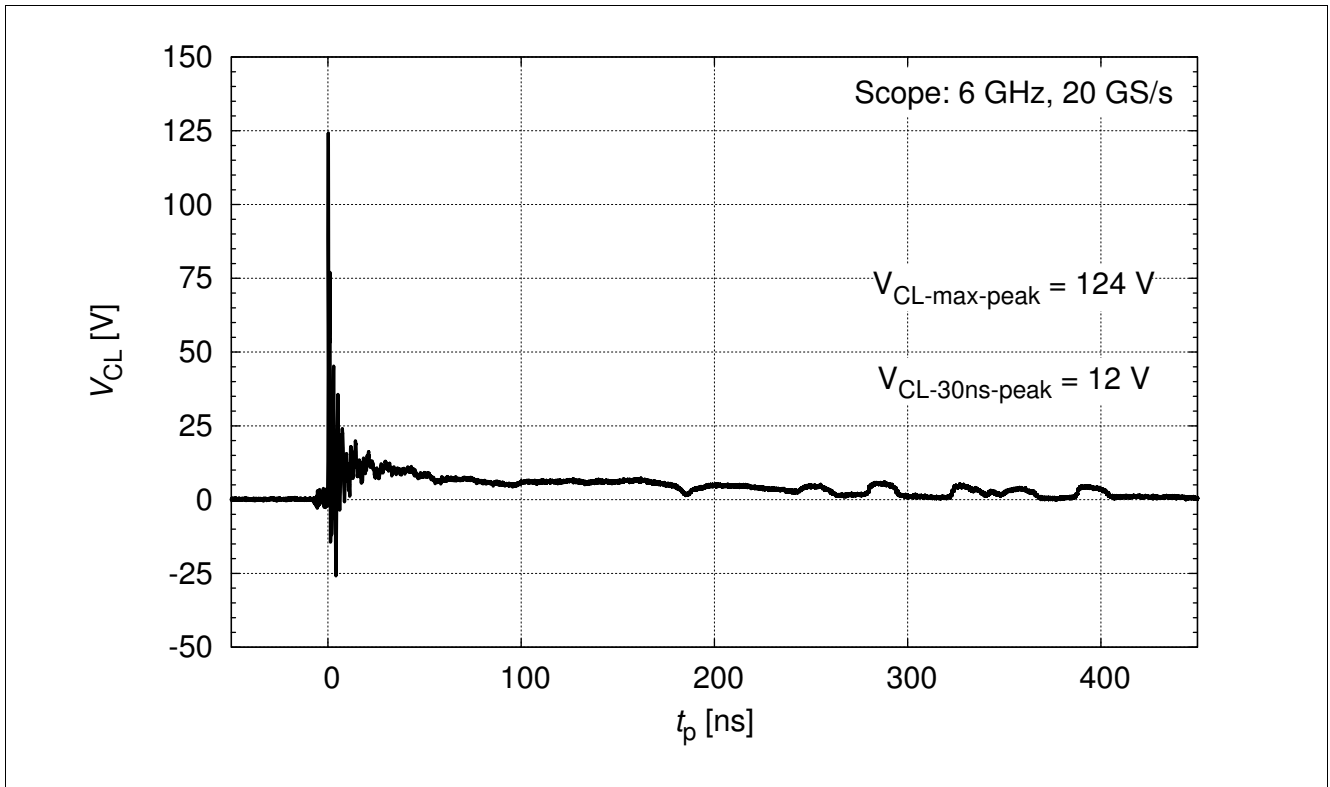

Figure 10 Clamping voltage at +15 kV discharge according IEC61000-4-2 ($R = 330\text{ Ohm}$, $C = 150\text{ pF}$)

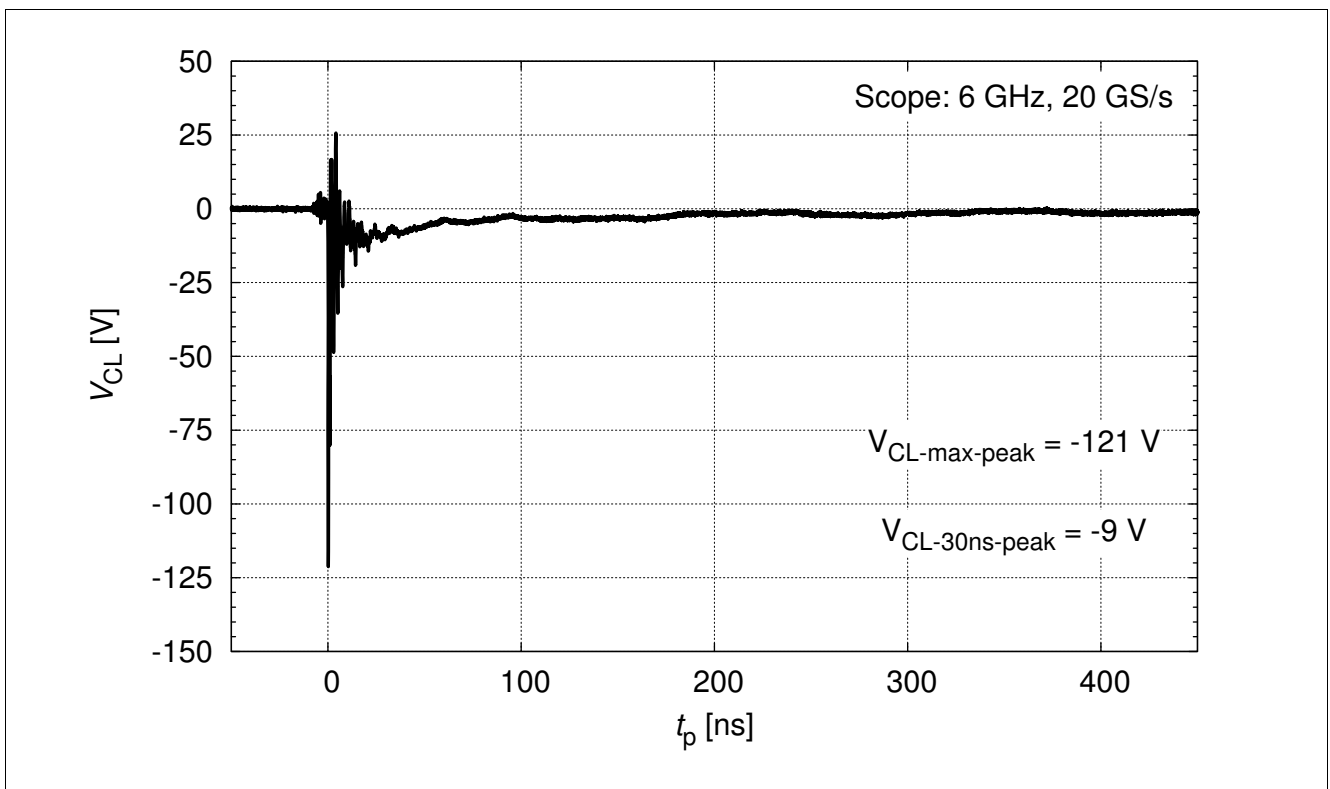

Figure 11 Clamping voltage at -15 kV discharge according IEC61000-4-2 ($R = 330\text{ }\Omega$, $C = 150\text{ pF}$)

4 Application Information

To design USB3.0 link for best system level ESD performance and error free Signal Integrity is mandatory.

To bring both requirements together, the ESD protection devices has to provide excellent ESD and a very low device capacitance. The Infineon ESD3V3U4ULC in “array” configuration, combined with a clear and straight forward “full through” layout fulfills these requirements in the best way.

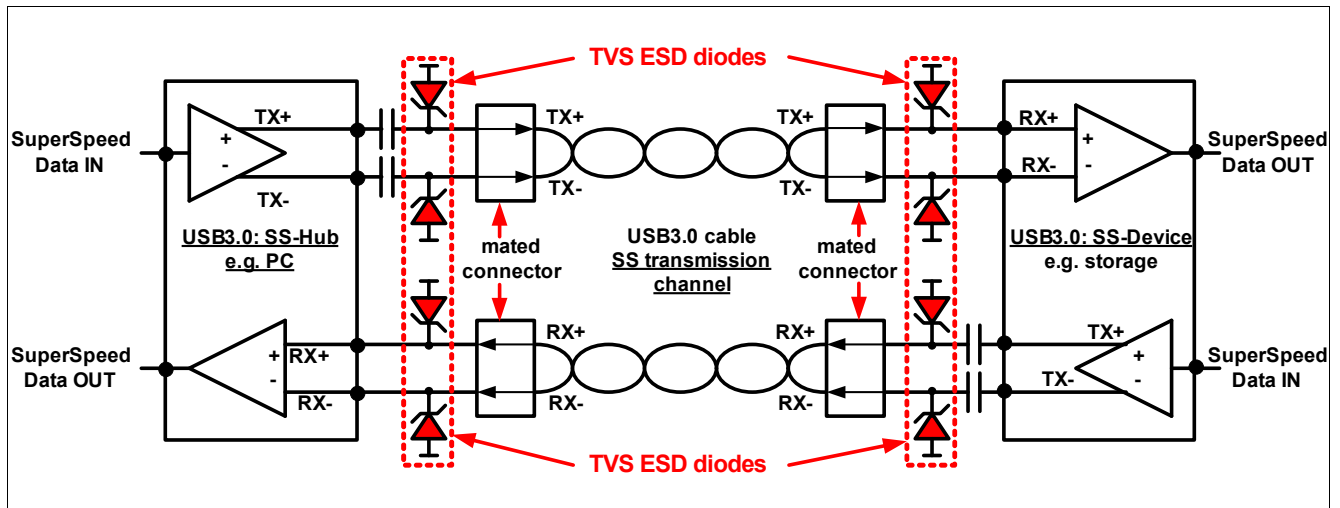

Figure 12 USB3.0 structure with ESD protection devices [3]

5 Ordering Information Scheme

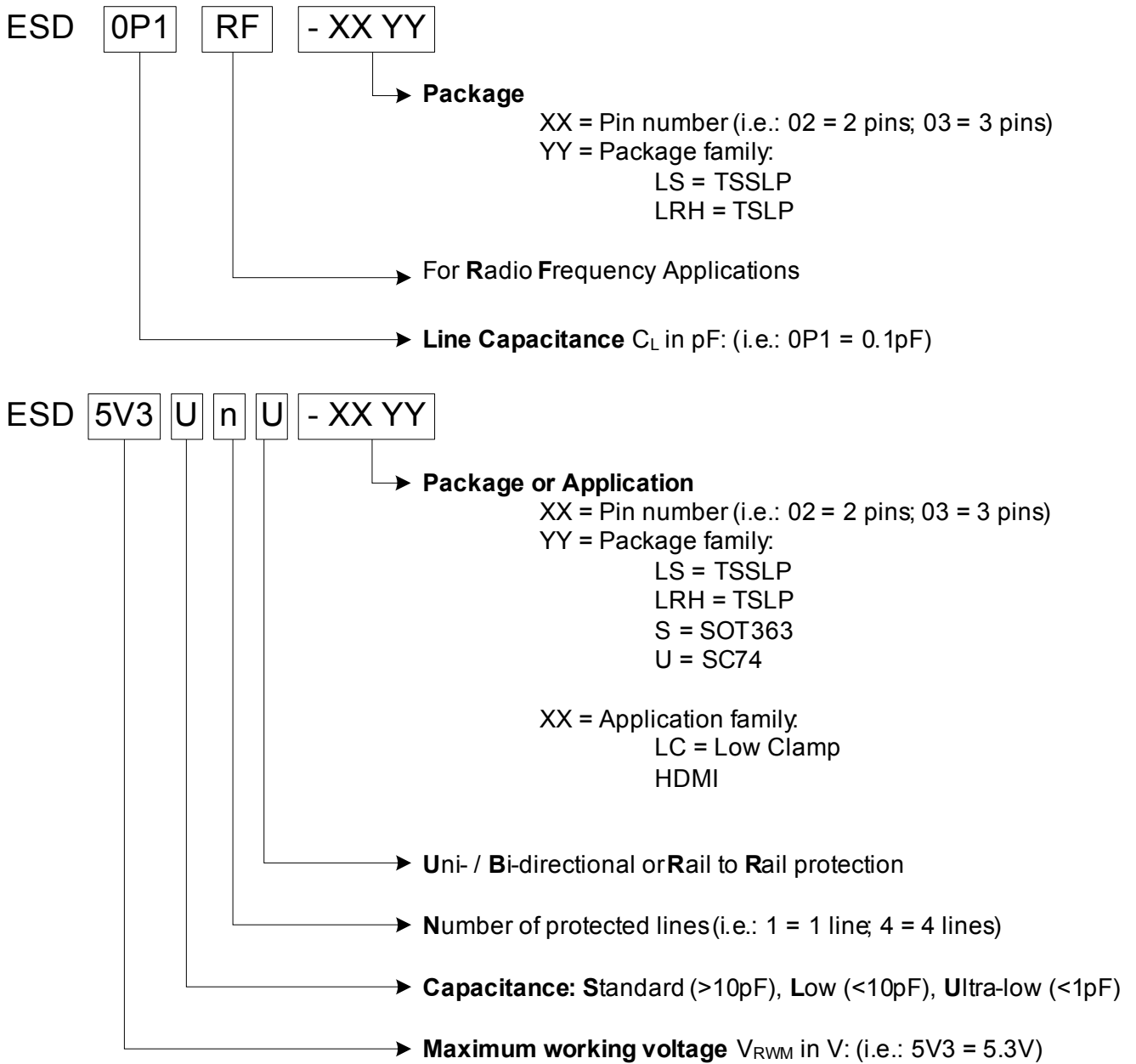

Figure 13 Ordering information scheme

6 Package Information

6.1 TSLP-9-1 (mm)

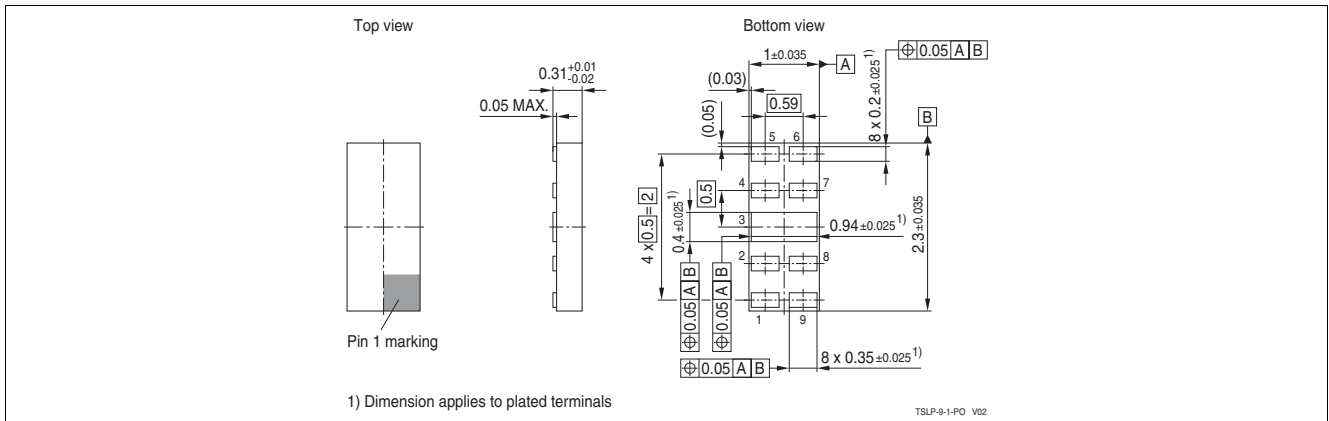

Figure 14 TSLP-9-1: Package overview

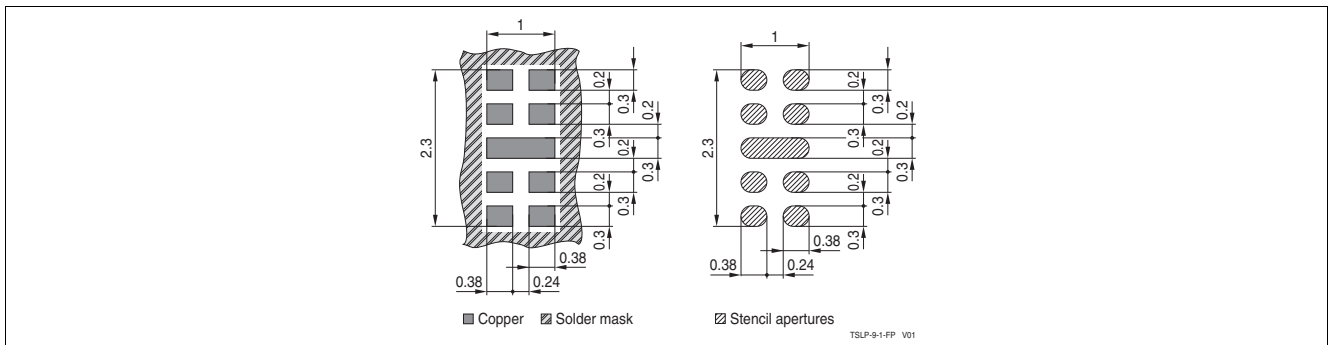

Figure 15 TSLP-9-1: Footprint

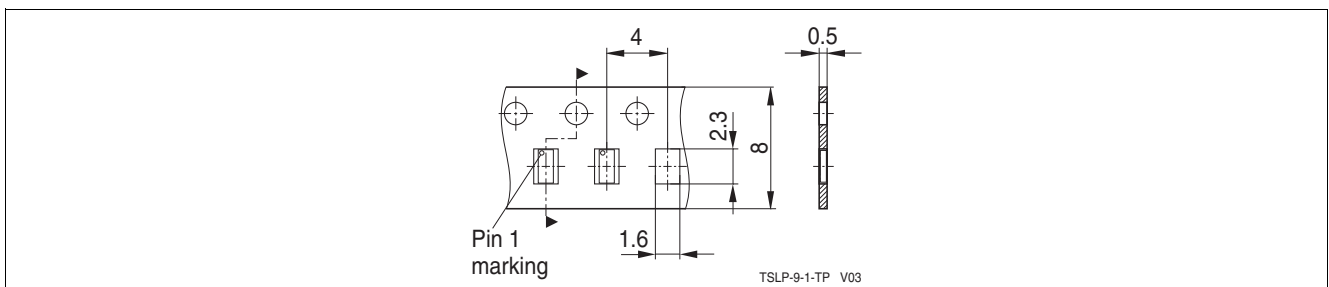

Figure 16 TSLP-9-1: Packing

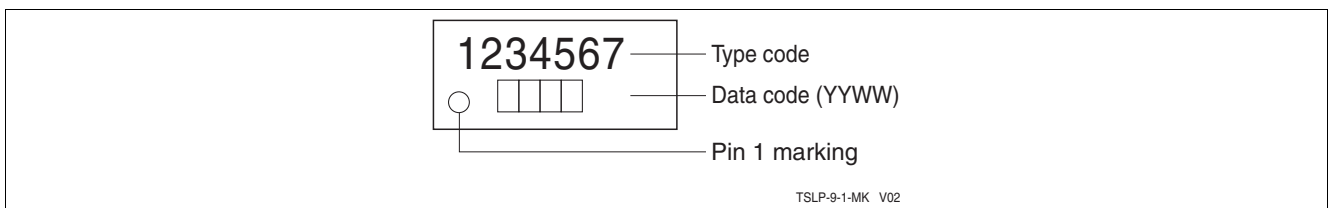

Figure 17 TSLP-9-1: Marking

References

- [1] **On-chip ESD protection for integrated circuits**, Albert Z. H. Wang, ISBN:0-7923-7647-1
- [2] Infineon Technologie AG - **Application Note AN210**: Effective ESD Protection Design at System Level Using VF-TLP Characterization Methodology
- [3] Infineon Technologie AG - **Application Note AN240**: Effective ESD Protection for USB3.0, combined with perfect Signal Integrity.

www.infineon.com

Published by Infineon Technologies AG