

PACDN1404

ESD Protection Arrays in Chip Scale Package

Product Description

The PACDN1404 and PACDN1408 are 4- and 8-channel transient voltage suppressor arrays that provide a very high level of protection for sensitive electronic components that may be subjected to ESD.

These devices are designed and characterized to safely dissipate ESD strikes at levels well beyond the maximum requirements set forth in the IEC 61000-4-2 international standard (Level 4, ± 8 kV contact discharge). All I/Os are rated at ± 25 kV using the IEC 61000-4-2 contact discharge method. Using the MIL-STD-883D (Method 3015) specification for Human Body Model (HBM) ESD, all pins are protected for contact discharges to greater than ± 30 kV.

The Chip Scale Package format of these devices provide extremely small footprints that are necessary in portable electronics such as cellular phones, PDAs, internet appliances and PCs. The large solder bumps allow for standard attachments to laminate boards without the use of underfill. The PACDN1404 and PACDN1408 are packaged in RoHS-compliant, lead-free finishing.

Features

- Four or Eight Transient Voltage Suppressors in a Single Package
- In-System Electrostatic Discharge (ESD) Protection to ± 25 kV Contact Discharge per IEC 61000-4-2 International Standard
- Compact Chip Scale Package (CSP) in a 0.65 mm Pitch Format Saves Board Space and Eases Layout in Space Critical Applications Compared to Discrete Solutions and Traditional Wire Bonded Packages
- 6- and 10-Bump WLCSPs
- These Devices are Pb-Free and are RoHS Compliant

Applications

- ESD Protection for Sensitive Electronic Equipment
- I/O Port, Keypad and Button Circuitry Protection for Portable Devices
- Wireless Handsets
- Handheld PCs / PDAs
- MP3 Players
- Digital Cameras and Camcorders
- Notebooks
- Desktop PCs



ON Semiconductor®

<http://onsemi.com>



WLCSP6
CG SUFFIX
CASE 567BD



WLCSP10
CG SUFFIX
CASE 567BM

ELECTRICAL SCHEMATIC

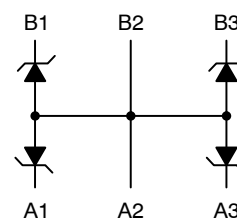

PACDN1404

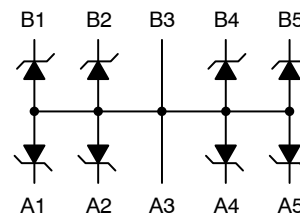

PACDN1408

MARKING DIAGRAM

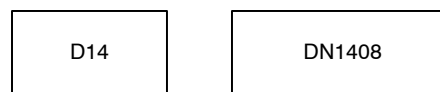

D14 = PACDN1404CG
DN1408 = PACDN1408CG

ORDERING INFORMATION

Device	Package	Shipping†
PACDN1404CG	WLCSP6 (Pb-Free)	3500/Tape & Reel
PACDN1408CG	WLCSP10 (Pb-Free)	3500/Tape & Reel

†For information on tape and reel specifications, including part orientation and tape sizes, please refer to our Tape and Reel Packaging Specification Brochure, BRD8011/D.

PACDN1404

PACKAGE / PINOUT DIAGRAMS

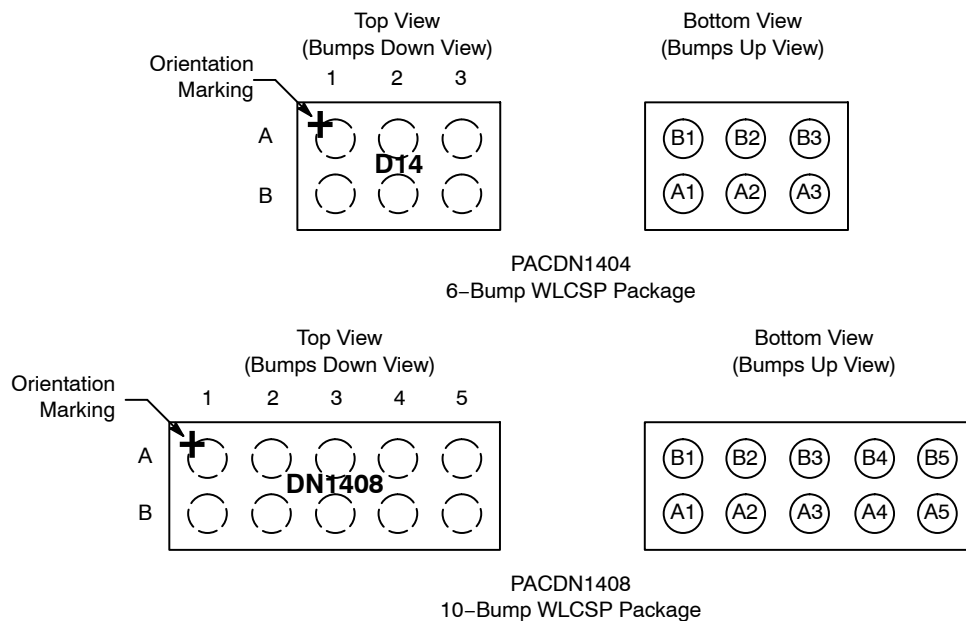

SPECIFICATIONS

Table 1. ABSOLUTE MAXIMUM RATINGS

Parameter	Rating	Units
Storage Temperature Range	-65 to +150	°C

Stresses exceeding Maximum Ratings may damage the device. Maximum Ratings are stress ratings only. Functional operation above the Recommended Operating Conditions is not implied. Extended exposure to stresses above the Recommended Operating Conditions may affect device reliability.

Table 2. STANDARD OPERATING CONDITIONS

Parameter	Rating	Units
Operating Temperature Range	-40 to +85	°C

Table 3. ELECTRICAL OPERATING CHARACTERISTICS (Note 1)

Symbol	Parameter	Conditions	Min	Typ	Max	Units
V_{REV}	Reverse Standoff Voltage	$I_{DIODE} = 10 \mu A$	5.5			V
I_{LEAK}	Leakage Current	$V_{IN} = 3.3 V DC$			100	nA
V_{SIG}	Signal Clamp Voltage Positive Clamp Negative Clamp	$I_{LOAD} = 10 mA$	5.6 -1.2	6.8 -0.8	8.0 -0.4	V
V_{ESD}	In-system ESD Withstand Voltage a) Human Body Model, MIL-STD-883, Method 3015 b) Contact Discharge per IEC 61000-4-2 Level 4	(Note 2)	± 30 ± 25			kV
V_{CL}	Clamping Voltage during ESD Discharge MIL-STD-883 (Method 3015), 8 kV Positive Transients Negative Transients	(Note 2)		+12 -8		V
C	Channel Capacitance	At 2.5 V DC, $f = 1 MHz$		39	47	pF

1. $T_A = 25^\circ C$ unless otherwise specified. GND in this document refers to the lower supply voltage.

2. ESD applied to channel pins with respect to GND, one at a time. All other channels are open. All GND pins tied to ground.

PACDN1404

APPLICATION INFORMATION

Parameter	Value
Pad Size on PCB	0.240 mm
Pad Shape	Round
Pad Definition	Non-Solder Mask Defined Pads
Solder Mask Opening	0.290 mm Round
Solder Stencil Thickness	0.125 mm – 0.150 mm
Solder Stencil Aperture Opening (Laser Cut, 5% Tapered Walls)	0.300 mm Round
Solder Flux Ratio	50/50 by Volume
Solder Paste Type	No Clean
Pad Protective Finish	OSP (Entek Cu Plus 106A)
Tolerance – Edge To Corner Ball	±50 μm
Solder Ball Side Coplanarity	±20 μm
Maximum Dwell Time Above Liquidous (183°C)	60 seconds
Maximum Soldering Temperature for Lead-free Devices Using a Lead-free Solder Paste	260°C

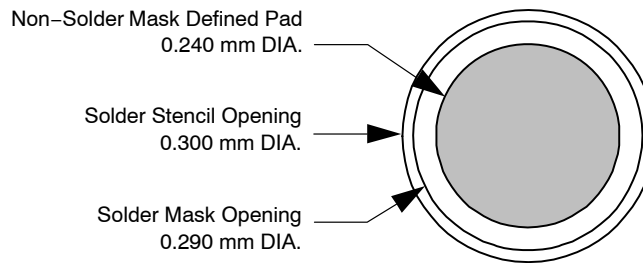

Figure 1. Recommended Non-Solder Mask Defined Pad Illustration

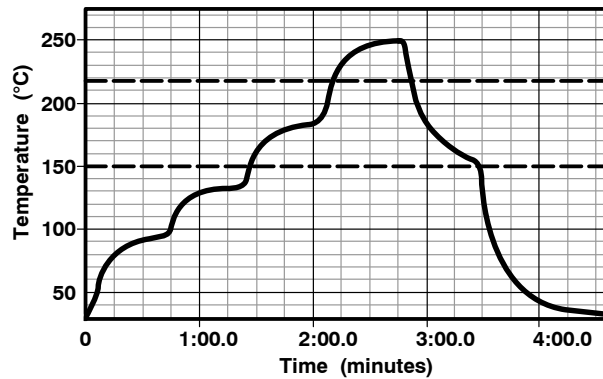
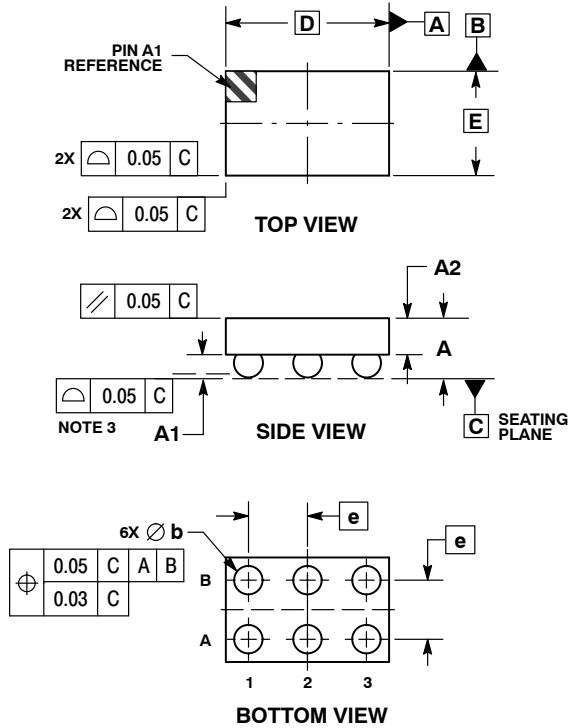

Figure 2. Lead-free (SnAgCu) Solder Ball Reflow Profile

PACDN1404

PACKAGE DIMENSIONS

WLCSP6, 1.80x1.15
CASE 567BD-01
ISSUE O



NOTES:

1. DIMENSIONING AND TOLERANCING PER ASME Y14.5M, 1994.
2. CONTROLLING DIMENSION: MILLIMETERS.
3. COPLANARITY APPLIES TO SPHERICAL CROWNS OF SOLDER BALLS.

DIM	MILLIMETERS	
	MIN	MAX
A	0.60	0.69
A1	0.23	0.29
A2	0.38	REF
b	0.34	0.39
D	1.80	BSC
E	1.15	BSC
e	0.65	BSC

RECOMMENDED SOLDERING FOOTPRINT*

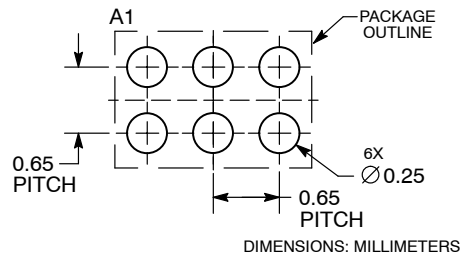

*For additional information on our Pb-Free strategy and soldering details, please download the ON Semiconductor Soldering and Mounting Techniques Reference Manual, SOLDERRM/D.

PACDN1404

PACKAGE DIMENSIONS

WLCSP10, 3.10x1.15
CASE 567BM-01
ISSUE 0

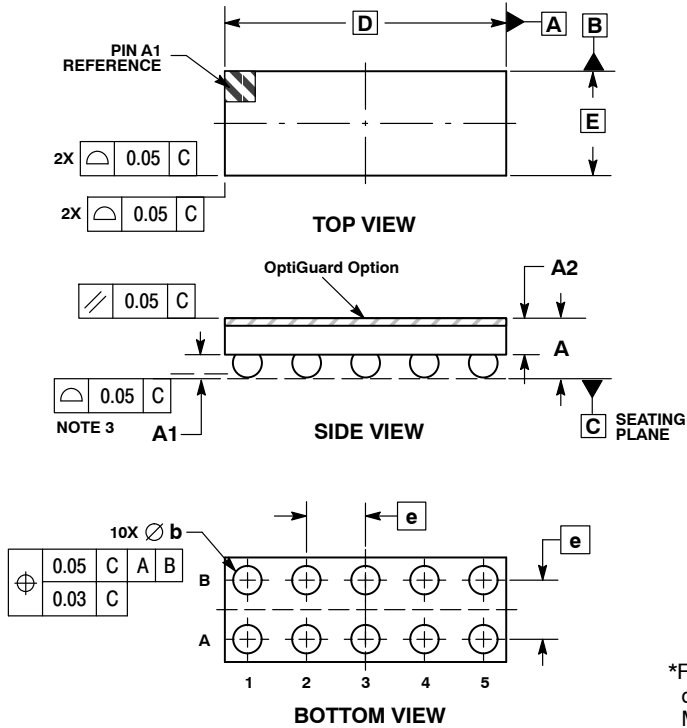

NOTES:

1. DIMENSIONING AND TOLERANCING PER ASME Y14.5M, 1994.
2. CONTROLLING DIMENSION: MILLIMETERS.
3. COPLANARITY APPLIES TO SPHERICAL CROWNS OF SOLDER BALLS.

DIM	MILLIMETERS	
	MIN	MAX
A	0.60	0.75
A1	0.23	0.29
A2	0.40	REF
b	0.34	0.39
D	3.10	BSC
E	1.15	BSC
e	0.65	BSC

RECOMMENDED SOLDERING FOOTPRINT*

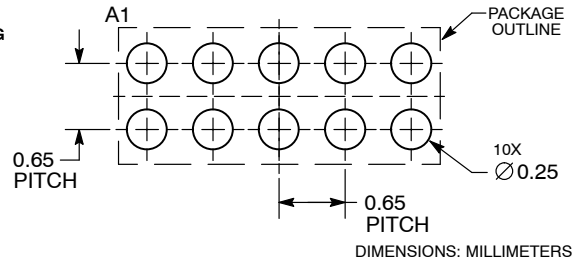

*For additional information on our Pb-Free strategy and soldering details, please download the ON Semiconductor Soldering and Mounting Techniques Reference Manual, SOLDERRM/D.

ON Semiconductor and are registered trademarks of Semiconductor Components Industries, LLC (SCILLC). SCILLC reserves the right to make changes without further notice to any products herein. SCILLC makes no warranty, representation or guarantee regarding the suitability of its products for any particular purpose, nor does SCILLC assume any liability arising out of the application or use of any product or circuit, and specifically disclaims any and all liability, including without limitation special, consequential or incidental damages. "Typical" parameters which may be provided in SCILLC data sheets and/or specifications can and do vary in different applications and actual performance may vary over time. All operating parameters, including "Typicals" must be validated for each customer application by customer's technical experts. SCILLC does not convey any license under its patent rights nor the rights of others. SCILLC products are not designed, intended, or authorized for use as components in systems intended for surgical implant into the body, or other applications intended to support or sustain life, or for any other application in which the failure of the SCILLC product could create a situation where personal injury or death may occur. Should Buyer purchase or use SCILLC products for any such unintended or unauthorized application, Buyer shall indemnify and hold SCILLC and its officers, employees, subsidiaries, affiliates, and distributors harmless against all claims, costs, damages, and expenses, and reasonable attorney fees arising out of, directly or indirectly, any claim of personal injury or death associated with such unintended or unauthorized use, even if such claim alleges that SCILLC was negligent regarding the design or manufacture of the part. SCILLC is an Equal Opportunity/Affirmative Action Employer. This literature is subject to all applicable copyright laws and is not for resale in any manner.

PUBLICATION ORDERING INFORMATION

LITERATURE FULFILLMENT:
 Literature Distribution Center for ON Semiconductor
 P.O. Box 5163, Denver, Colorado 80217 USA
Phone: 303-675-2175 or 800-344-3860 Toll Free USA/Canada
Fax: 303-675-2176 or 800-344-3867 Toll Free USA/Canada
Email: orderlit@onsemi.com

N. American Technical Support: 800-282-9855 Toll Free USA/Canada
Europe, Middle East and Africa Technical Support:
 Phone: 421 33 790 2910
Japan Customer Focus Center
 Phone: 81-3-5817-1050

ON Semiconductor Website: www.onsemi.com
Order Literature: <http://www.onsemi.com/orderlit>
 For additional information, please contact your local Sales Representative